

eurostat 

European business statistics
geonomenclature applicable
to European statistics on
international trade in goods

2024 edition

MANUALS AND
GUIDELINES

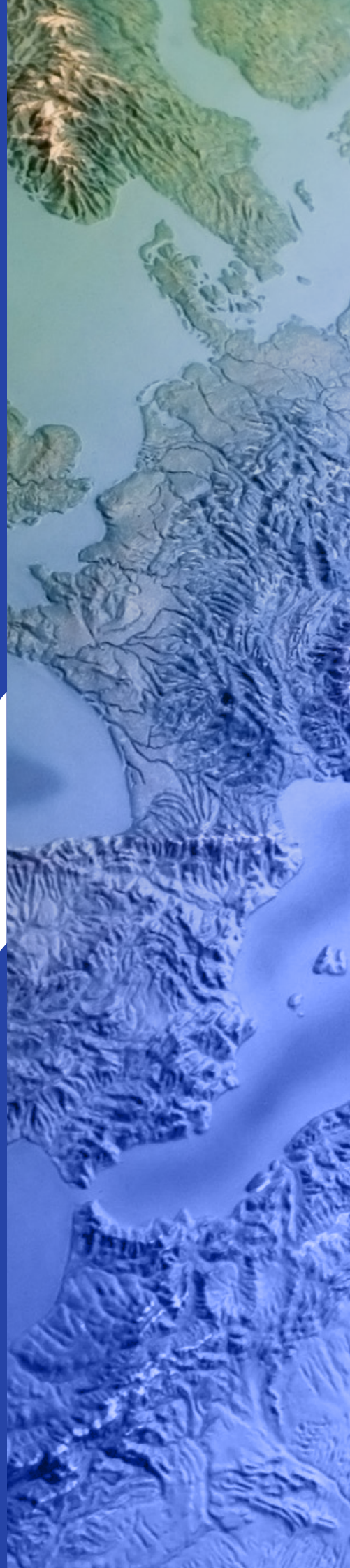

**European business statistics
geonomenclature applicable
to European statistics on
international trade in goods** | **2024 edition**

Manuscript completed in March 2024

The Commission is not liable for any consequence stemming from the reuse of this publication.

Luxembourg: Publications Office of the European Union, 2024

© European Union, 2024



The reuse policy of European Commission documents is implemented based on Commission Decision 2011/833/EU of 12 December 2011 on the reuse of Commission documents (OJ L 330, 14.12.2011, p. 39). Except otherwise noted, the reuse of this document is authorised under a Creative Commons Attribution 4.0 International (CC-BY 4.0) licence (<https://creativecommons.org/licenses/by/4.0/>). This means that reuse is allowed provided appropriate credit is given and any changes are indicated.

For any use or reproduction of elements that are not owned by the European Union, permission may need to be sought directly from the respective rightholders. The European Union does not own the copyright in relation to the following elements:

Copyright for the photographs: Cover © Adobe stock

Theme: International trade

Collection: Manuals and guidelines

PDF: ISBN 978-92-68-13412-2 ISSN 2315-0815 doi: 10.2785/970446 KS-GQ-24-008-EN-N

Contents

Contents	3
Abbreviations	5
1. Introduction	6
1.1. What is the purpose of this publication?.....	6
1.2. Which other documents should be read in conjunction with this publication?	6
1.3. Where to find everything on European ITGS?	7
2. Background information	9
2.1. What is a statistical classification or nomenclature?	9
2.2. What is the purpose of the Geonomenclature?.....	9
2.3. How is the Geonomenclature evolving?.....	9
2.4. Alphabetical or numerical country codes?.....	11
2.5. Does the Geonomenclature match with the ISO 3166 standard?.....	12
2.6. Which country nomenclature in which datasets?	12
2.7. How are economic or geographical zones coded?	13
3. Geonomenclature	15
3.1. Legal basis.....	15
3.2. Latest changes	15
3.2.1. Reasons for changes	15
3.2.2. Changes in country codes and labels	16
3.3. Geonomenclature in force	17
3.3.1. Country codes and descriptions.....	17
3.3.2. Miscellaneous codes	29
4. Development of the codes	31
5. Economic zones	45
5.1. Changes since 2007.....	45
5.2. Latest compositions	50
5.2.1. European Union	50
5.2.2. Euro area.....	52
5.2.3. Other economic zones	54
6. Geographical zones	59
6.1. Changes since 2007.....	59
6.2. Latest compositions	61
7. Maps	65
7.1. World	66
7.2. Europe	67

7.2.1. European Union	67
7.2.2. European countries excluding EU	68
7.3. Africa.....	69
7.3.1. North Africa	69
7.3.2. Other African countries.....	70
7.4. America.....	71
7.4.1. North America	71
7.4.2. Central America and Caribbean.....	72
7.4.3. South America.....	73
7.5. Asia.....	74
7.5.1. Near and Middle Eastern countries.....	74
7.5.2. Other Asian countries.....	75
7.6. Oceania and Polar regions	76
7.6.1. Australia and New Zealand	76
7.6.2. Other countries of Oceania and Polar regions.....	77
8. Correspondence codes — zones	78
9. Correspondence ISO 3166 — Geonomenclature	93
9.1. From ISO 3166 to Geonomenclature	93
9.2. ISO 3166 codes not existing in Geonomenclature.....	100
9.3. Geonomenclature codes not existing in ISO 3166.....	100
10.Link to Eurostat's online database (data navigation tree) code list	102
10.1. Use of Eurostat's online database code list.....	102
10.2. Conversion of codes	103
10.2.1. Country codes	103
10.2.2. Economic zones.....	104
10.2.3. Geographical zones	105
11.Alphabetical index.....	107

Abbreviations

EA	Euro area
EBS	European business statistics
ESS	European Statistical system
EU	European Union
GEONOM	Geonomenclature
ITGS	International trade in goods statistics
UN	United Nations

1

Introduction

1.1. What is the purpose of this publication?

The purpose of this publication is to provide the compilers and users of European statistics on international trade in goods with sound information on the nomenclature used to classify the reporting and partner countries. Besides including the latest version ([Commission Implementing Regulation \(EU\) 2020/1470 of 12 October 2020](#)) of the *nomenclature of countries and territories for the European statistics on international trade in goods and on the geographical breakdown for other business statistics* — known as the ‘*Geonomenclature*’ and abbreviated to GEONOM —, it also contains all the supplementary information that is essential to understand the content of this country classification and the evolution of its codes.

A further aim of this publication is to document the geographical and economic areas covered by the trade in goods statistics as disseminated by Eurostat via its [Data Navigation Tree](#) or via [Comext](#), Eurostat’s reference database for international trade in goods.

In our effort to continuously improve our publications we invite our readers to provide any comments or suggestions they may have to the Comext support team at comextsupport@ec.europa.eu.

1.2. Which other documents should be read in conjunction with this publication?

Further guidance and metadata on ITGS are available from the following sources:

- The [International Trade Data Reference Metadata](#) in Single Integrated Metadata Structure (SIMS) — These metadata cover methodological, qualitative and quantitative information in a standardised structure.
- The Statistical Explained article [International trade statistics – background](#) — This article answers some frequently asked questions on European ITGS.
- The [European business statistics user manual on EU international trade in goods statistics](#) — The purpose of this user manual is to explain to a wide range of users how the statistics relating to trade in goods, both between EU Member States and with non-EU countries, are collected, compiled, processed and published at European level. The different issues are tackled in a question and answer format.
- The [European business statistics compilers' manual for international trade in goods statistics – detailed data](#) — The purpose of this publication is to provide the compilers of European statistics on international trade in goods (ITGS) with clarifications on how to apply the EU legal provisions. With the help of concrete examples, clear text, definitions and systematic legislative references, the Manual is meant to serve as a practical reference document for National Statistical Authorities involved in the compilation of European ITGS.
- The [European business statistics compilers' manual for international trade in goods statistics –](#)

[aggregated data](#) — This compilers' manual is meant to serve as a practical reference document for all National Statistical Authorities involved in the compilation of aggregated data on EU international trade in goods statistics. As such, it provides the necessary definitions and practical instructions regarding the preparation and transmission of aggregated data to Eurostat.

- The [European business statistics compilers' manual for international trade in goods statistics – trade by enterprise characteristics](#) — This compilers' manual is meant to serve as a practical reference document for all National Statistical Authorities involved in the compilation of EU statistics on trade in goods by enterprise characteristics (TEC). As such, it provides the necessary definitions and practical instructions regarding the preparation and transmission of TEC data to Eurostat.
- The [European business statistics compilers' manual for international trade in goods statistics – trade by invoicing currency](#) — This compilers' manual is meant to serve as a practical reference document for all National Statistical Authorities involved in the compilation of EU statistics on trade in goods by invoicing currency (TIC). As such, it provides the necessary definitions and practical instructions regarding the preparation and transmission of TIC data to Eurostat.
- The [Legislation page of Eurostat's website](#) dedicated to International trade in goods.

1.3. Where to find everything on European ITGS?

The Eurostat website gives access to sections dedicated to specific statistical domains. One of these sections relates to statistics on [international trade in goods](#). It provides useful data paths, infographics tools, answers to frequently asked questions as well as links to all available metadata including manuals, guidelines, quality reports, classifications and legal acts.

'International trade in goods' dedicated section on Eurostat website

<https://ec.europa.eu/eurostat/web/international-trade-in-goods>

Overview

Database

- Selected datasets
- Detailed datasets
- Additional access to the data
 - Comext database
 - Bulk download

Visualisations

Publications

- Euro indicators (incl. release calendar)
- News articles
- Statistics Explained articles
- Statistical publications
- Methodological publications

Information on data

- Overview
- Available indicators
- Reference period and data release
- Data revisions
- Data sources

Methodology

- Metadata
- Classifications
- Further reading

Quality

- Quality indicators
- Quality reports

Legislation

2

Background information

2.1. What is a statistical classification or nomenclature?

A statistical classification or nomenclature is an exhaustive and structured set of mutually exclusive and well-described categories, often presented in a hierarchy that is reflected by the numeric or alphabetical codes assigned to them, used to standardise concepts and compile statistical data.

Some classifications, like the NACE (Statistical Classification of Economic Activities), are multidisciplinary, i.e. applicable in different statistical domains, while others are very closely related to their domain, like the European Shortlist for Causes of Death.

The classifications used by Eurostat and the EU Member States are specified in regulations or gentleman's agreements. This procedure ensures that the data published at European level are comparable between Member States. Note that, at national level, Member States may use a different, nationally adapted version of a classification.

2.2. What is the purpose of the Geonomenclature?

Data collection

The 'Nomenclature of countries and territories for the European statistics on international trade in goods and on the geographical breakdown for other business statistics', known as the '[Geonomenclature](#)' and abbreviated to GEONOM, is used by the EU Member States to **collect** detailed statistics on their exchanges of goods with other Member States (intra-EU trade) or with non-EU countries (extra-EU trade).

Data dissemination

The Geonomenclature is also used by Eurostat to **disseminate** data through [Comext](#), Eurostat's reference database for international trade in goods. Comext provides access not only to recent and historical trade data of the EU and its individual Member States but also to the trade statistics of a significant number of non-EU countries.

2.3. How is the Geonomenclature evolving?

Reasons for changes

The Geonomenclature is subject to revisions in order to incorporate the adjustments needed for statistical and customs purposes and to take into account any geopolitical changes that may have occurred. The alphabetical coding of countries and territories is based on the current version of the standard ISO alpha 2 (ISO 3166), insofar as it is compatible with the requirements of the EU legislation. Note that a correspondence with the former 3-digit numerical coding is still maintained.

Changes implemented through legal provisions

From 2011 onwards, measures relating to changes in country codes and their format shall be adopted by the Commission by means of implementing acts. The European Statistical System Committee shall assist the Commission in that task. The Geonomenclature was previously maintained via Commission regulations, in accordance with the opinion of the Committee on Statistics Relating to the Trading of Goods with Non-Member Countries.

Geonomenclature in EU legislation — An overview of the last 25 years

Legal acts currently in force

- 2020-10-12 [Commission Implementing Regulation \(EU\) 2020/1470 of 12 October 2020](#) on the nomenclature of countries and territories for the European statistics on international trade in goods and on the geographical breakdown for other business statistics (Text with EEA relevance) – Changes with effect from 1 January 2021
- 2020-01-31 The [Protocol on Ireland/Northern Ireland](#) of the Agreement on the withdrawal of the United Kingdom of Great Britain and Northern Ireland from the European Union and the European Atomic Energy Community – In force from 1 January 2021

Previous legal acts

- 2019-03-19 [Regulation \(EU\) 2019/474 of the European Parliament and of the Council of 19 March 2019](#) amending Regulation (EU) No 952/2013 laying down the Union Customs Code — Change with effect from 1 January 2020
- 2012-11-27 [Commission Regulation \(EU\) No 1106/2012 of 27 November 2012](#) implementing Regulation (EC) No 471/2009 of the European Parliament and of the Council on Community statistics relating to external trade with non-member countries, as regards the update of the nomenclature of countries and territories (Text with EEA relevance)
- 2012-07-11 [European Council Decision 2012/419/EU of 11 July 2012](#) amending the status of Mayotte with regard to the European Union — Change with effect from 1 January 2014
- 2006-12-13 [Commission Regulation \(EC\) No 1833/2006 of 13 December 2006](#) on the nomenclature of countries and territories for the external trade statistics of the Community and statistics of trade between Member States (Text with EEA relevance)
- 2005-05-18 [Commission Regulation \(EC\) No 750/2005 of 18 May 2005](#) on the nomenclature of countries and territories for the external trade statistics of the Community and statistics of trade between Member States (Text with EEA relevance)
- 2003-11-27 [Commission Regulation \(EC\) No 2081/2003 of 27 November 2003](#) on the nomenclature of countries and territories for the external trade statistics of the Community and statistics of trade between Member States (Text with EEA relevance)
- 2002-10-04 [Commission Regulation \(EC\) No 1779/2002 of 4 October 2002](#) on the nomenclature of countries and territories for the external trade statistics of the Community and statistics of trade between Member States (Text with EEA relevance)
- 2001-10-15 [Commission Regulation \(EC\) No 2020/2001 of 15 October 2001](#) on the nomenclature of countries and territories for the external trade statistics of the Community and statistics of trade between Member States (Text with EEA relevance)
- 2000-09-27 [Commission Regulation \(EC\) No 2032/2000 of 27 September 2000](#) on the nomenclature of countries and territories for the external trade statistics of the Community and statistics of trade between Member States (Text with EEA relevance)

1999-12-01	Commission Regulation (EC) No 2543/1999 of 1 December 1999 on the nomenclature of countries and territories for the external trade statistics of the Community and statistics of trade between Member States (Text with EEA relevance)
1998-12-09	Commission Regulation (EC) No 2645/98 of 9 December 1998 on the nomenclature of countries and territories for the external trade statistics of the Community and statistics of trade between Member States (Text with EEA relevance)
1997-05-20	Commission Regulation (EC) No 895/97 of 20 May 1997 on the country nomenclature for the external trade statistics of the Community and statistics of trade between Member States (Text with EEA relevance)

Where it all began

The very first version of the Geonomenclature (valid as from 1 January 1975) was included in Annex C of [Regulation \(EEC\) No 1736/75 of the Council of 24 June 1975](#) on the external trade statistics of the Community and statistics of trade between Member States.

- Article 6

1. In the statistical information medium, countries and territories shall be described in such a way that they may be easily and accurately classified under the appropriate heading of the country nomenclature for the external trade statistics of the Community and statistics of trade between the Member States referred to in Article 35.

2. The code number given in the country nomenclature for the external trade statistics of the Community and statistics of trade between Member States must be indicated for each country.

- Article 35

The data referred to in Article 22 (1) shall be compiled by country according to the current version of the country nomenclature for the external trade statistics of the Community and statistics of trade between Member States given in Annex C.

2.4. Alphabetical or numerical country codes?

Alpha-2 codes in data transmitted to Eurostat

Since 1 January 1999 (see [Commission Regulation \(EC\) No 2645/98 of 9 December 1998](#)), the Geonomenclature is based on the standard ISO alpha-2 (ISO 3166). However the EU Member States were allowed to continue using the former 3-digit numerical coding until December 2003 as reference month.

Alpha-2 or numerical codes in the Comext datasets

- Alpha-2 codes are used in monthly or yearly updated Comext datasets.
- Numerical codes are used in daily updated Comext datasets as well as for historical data relating to periods prior to 1988. To ensure the continuity of the time series, the numerical coding has been maintained to store the data transmitted by the EU Member States. The numerical codes are transcoded into the alpha-2 format for the monthly and yearly updated Comext datasets only.

Note that, in any Comext dataset using the numerical format of the Geonomenclature, a '0' is added as an extra first digit to the 3-digit numerical country codes listed in the 'PARTNER' statistical dimension. As an example, the partner 'United States' appears under the code 0400 instead of 400. The purpose is to ensure consistency between the country and zone coding.

2.5. Does the Geonomenclature match with the ISO 3166 standard?

What is ISO 3166?

ISO 3166 is the International Standard for country codes and codes for their subdivisions. The purpose of ISO 3166 is to define internationally recognised codes of letters and/or numbers which can be used to refer to countries and subdivisions. However, it does not define the names of countries – this information comes from United Nations sources (Terminology Bulletin Country Names and the Country and Region Codes for Statistical Use maintained by the United Nations Statistics Divisions).

The country codes can be represented either as a two-letter code (alpha-2) which is recommended as the general purpose code, a three-letter code (alpha-3) which is more closely related to the country name and a three digit numeric code (numeric-3) which can be useful to avoid using Latin script.

ISO 3166 is regularly updated to reflect changes in country names and subdivisions. These changes are done by the ISO 3166 Maintenance Agency (ISO3166/MA).

Correspondence between Geonomenclature and ISO 3166

The similarities and the differences are all documented in [Chapter 9 Correspondence ISO 3166 – Geonomenclature](#) on the basis of the following flags:

- * = Full correspondence
- + = Partial correspondence
- ** = ISO 3166 code classified under a different Geonomenclature code
- >>> = Geonomenclature codes with no correspondence in ISO 3166

The Geonomenclature matches with the ISO 3166 standard for most countries. In a few cases, the same code corresponds to a larger territory either in the Geonomenclature or in the ISO 3166 standard.

2.6. Which country nomenclature in which datasets?

European statistics on international trade in goods are disseminated on the Eurostat website through different datasets. Those datasets are all gathered under the theme 'International trade' and the '[International trade in goods](#)' dedicated branch.

The figure below shows that trade in goods data are grouped into four categories: aggregated data, detailed data, trade by enterprise characteristics and trade by invoicing currency.

Database

 Information on the database

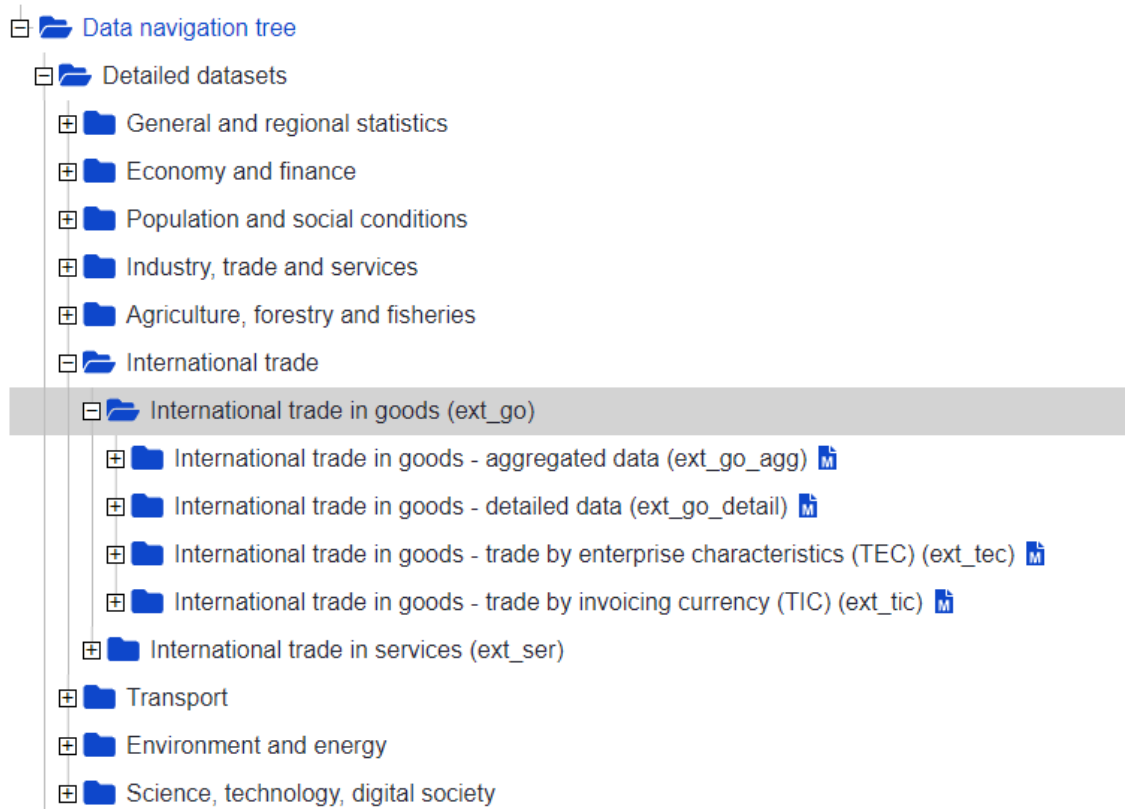

The geopolitical entities (reporting and partner countries) of the '**Aggregated data**', '**Trade by enterprise characteristics**' and '**Trade by invoicing currency**' datasets are based on Eurostat's online database code list while the reporter and partner dimensions of the '**Detailed data**' datasets are coded according to the Geonomenclature (alpha or numerical version).

More details on Eurostat's online database code list are provided in [Chapter 10 Link to Eurostat's online database \(data navigation tree\) code list](#).

2.7. How are economic or geographical zones coded?

In order to answer further user needs, the Geonomenclature is complemented by partner codes relating to economic and geographical zones. Those zones are defined on the basis of 4-digit numerical codes as shown in the examples below. The zones and their respective composition are documented in [Chapter 5 Economic zones](#) and [Chapter 6 Geographical zones](#). The geographical zones are graphically presented in [Chapter 7 Maps](#).

Examples of economic zones (codes 1xxx):

- 1010 European Union (evolutionary definition)
- 1013 Euro area since 1999 (evolutionary definition)
- 1031 ACP — African, Caribbean and Pacific countries
- 1053 OPEC — Organisation of Petroleum Exporting Countries

Examples of geographical zones (codes 5xxx):

- 5000 World
- 5300 America
- 5310 North America
- 5320 Central America and Caribbean

3

Geonomenclature

3.1. Legal basis

The country classification currently in application is laid down by the [Commission Implementing Regulation \(EU\) 2020/1470](#) of 12 October 2020 on the nomenclature of countries and territories for the European statistics on international trade in goods and on the geographical breakdown for other business statistics — **Version valid as from 1 January 2021**

For an overview of the legislative developments over the past decades, see [section 2.3. How is the Geonomenclature evolving?](#)

3.2. Latest changes

3.2.1. REASONS FOR CHANGES

Changes with effect from 1 January 2021

- Need to distinguish – according to the conditions laid down in relevant provisions of Union law – between United Kingdom (in respect of Northern Ireland) and United Kingdom (excluding Northern Ireland). Codes XI and XU are therefore created, with effect from 1 January 2021. These changes are to be seen in the broader context of the withdrawal of the United Kingdom from the European Union, and of the specific provisions agreed so as to avoid a hard border between Ireland and Northern Ireland.

Changes with effect from 1 January 2020

- The Italian municipality of Campione d'Italia, an Italian exclave in the territory of Switzerland, and the Italian waters of Lake Lugano should be included in the customs territory of the Union because the historical reasons justifying the exclusion of those territories, such as their isolation and economic disadvantages, no longer apply. For the same reasons, those territories should be included in the general arrangements for excise duty while continuing to be excluded from the common system of value added tax. In order to ensure that these changes apply consistently from the same point in time, the inclusion of those territories in the customs territory of the Union should apply from 1 January 2020.

Changes with effect from 1 January 2014

- With effect from 1 January 2014, Mayotte shall cease to be an overseas country or territory, to which the provisions of Part Four of the Treaty on the Functioning of the European Union (TFEU) apply, and shall become an outermost region of the Union within the meaning of Article 349 TFEU.

3.2.2. CHANGES IN COUNTRY CODES AND LABELS

Latest changes in country codes

Creation of codes

Code		Label	Year / Description
ALPHA-2	NUM		
2021			
XI	(015)	United Kingdom (Northern Ireland)	Code to be used if United Kingdom (in respect of Northern Ireland) needs to be distinguished according to the conditions laid down in the relevant Union provisions.
XU	(016)	United Kingdom (excluding Northern Ireland)	Code to be used if United Kingdom (excluding Northern Ireland) needs to be distinguished according to the conditions laid down in the relevant Union provisions.

Deletion of codes

Code		Label	Year / Description
ALPHA-2	NUM		
2014			
YT	(377)	Mayotte	Grande-Terre and Pamandzi

Latest changes in contents

Code		Label	Year / Changes
ALPHA-2	NUM		
2020			
IT	(005)	Italy	Including the municipality of Campione d'Italia (which appeared under code CH (039) Switzerland until 2019) and the Italian waters of Lake Lugano
2014			
FR	(001)	France	Including the overseas department Mayotte (which appeared under code YT (377) until 2013)

Latest changes in labels

Code		Label	Year / Former label
ALPHA-2	NUM		
2021¹			
CV	(247)	Cabo Verde	Cape Verde
CZ	(061)	Czechia	Czech Republic
KG	(083)	Kyrgyzstan	Kyrgyz, Republic
MK	(096)	North Macedonia	Former Yugoslav Republic of Macedonia
SZ	(393)	Eswatini	Swaziland
VA	(045)	Holy See	Holy See (Vatican City State)

3.3. Geonomenclature in force

3.3.1. COUNTRY CODES AND DESCRIPTIONS

Version valid as from 1 January 2021

Code		Text	Description	Observations
ALPHA-2	NUM			
1	2	3	4	5
AD	(043)	Andorra		
AE	(647)	United Arab Emirates	Abu Dhabi, Ajman, Dubai, Fujairah, Ras al Khaimah, Sharjah and Umm al Qaiwain	
AF	(660)	Afghanistan		
AG	(459)	Antigua and Barbuda		Including Redonda Island.
AI	(446)	Anguilla		Including Sombrero Island. See code GB (006).
AL	(070)	Albania		
AM	(077)	Armenia		Until 30 June 1992 Armenia appeared under code SU (056) USSR.
AO	(330)	Angola	Including Cabinda	The enclave of Cabinda is bordered by Congo, Congo (Dem. Rep.) and the Atlantic Ocean.
AQ	(891)	Antarctica	Territory south of 60° south latitude; not including the French Southern Territories (TF), Bouvet Island (BV), South Georgia and South Sandwich Islands (GS)	Including Adelie Land, Australian Antarctic Territory, Peter 1st Island, Queen Maud Land, Ross Dependency and British Antarctic Territory including South Orkney Islands, South Shetland Islands and the Antarctic Peninsula.
AR	(528)	Argentina		Including the territory of Tierra del Fuego (the eastern part of Tierra del Fuego island and several small islands, including Staten Island).

¹ These changes in labels all came into effect from 1 January 2021 with the implementation of the latest version of the Geonomenclature (Commission Implementing Regulation (EU) 2020/1470 of 12 October 2020). However, the European Union was already officially using the following changed names in previous years: in 2018 – 'Czech Republic' replaced by 'Czechia', 'Swaziland' replaced by 'Eswatini'; and in 2019 – 'North Macedonia' (new denomination), 'Cape Verde' replaced by 'Cabo Verde'.

Code		Text	Description	Observations
ALPHA-2	NUM			
1	2	3	4	5
AS	(830)	American Samoa		American Samoa Archipelago comprises seven islands: Ta'u, Olosega, Ofu, Aunu'u, Rose, Swains and Tutuila. See code US (400).
AT	(038)	Austria		
AU	(800)	Australia		The following territories, although under Australian administration, appear under the following codes: CC (833) - Cocos (Keeling), Islands, CX (834) - Christmas Island, HM (835) - Heard Island and McDonald Islands and NF (836) - Norfolk Island.
AW	(474)	Aruba		Located in the Lesser Antilles, with semi-autonomous status since 1986. See code NL (003).
AZ	(078)	Azerbaijan		Until 30 June 1992 Azerbaijan appeared under code SU (056) USSR. Azerbaijan also includes the Nagorno-Karabakh Autonomous Province and the Nakhichevan Autonomous Republic.
BA	(093)	Bosnia and Herzegovina		Until 30 June 1992 Bosnia and Herzegovina appeared under code YU (048) - Yugoslavia. See code SI (091).
BB	(469)	Barbados		
BD	(666)	Bangladesh		
BE	(017)	Belgium		
BF	(236)	Burkina Faso		Formerly Upper Volta until 1984.
BG	(068)	Bulgaria		
BH	(640)	Bahrain		Consisting of 33 islands, the most important of which are Bahrain, Mouharraq and Sitrah.
BI	(328)	Burundi		
BJ	(284)	Benin		
BL	(466)	Saint Barthélemy		Overseas collectivity of France in the West Indies. The collectivity is one of four territories among the Leeward Islands in the north eastern Caribbean that comprise the French West Indies, along with Saint Martin, Guadeloupe and Martinique.
BM	(413)	Bermuda		The major islands are Great Bermuda (or Main Island), Somerset, Ireland, St George, St David and Boaz. See code GB (006).
BN	(703)	Brunei Darussalam	Often referred to as Brunei	Officially called Negara Brunei Darussalam. Located on the island of Borneo.
BO	(516)	Bolivia, Plurinational State of	Often referred to as Bolivia	
BQ	(477)	Bonaire, Sint Eustatius and Saba		Under code AN (478) Netherlands Antilles until 2012. See code NL (003).
BR	(508)	Brazil		Including Fernando de Noronha Island, Martim Vez Islands, Trindade Island.
BS	(453)	Bahamas		The archipelago includes primarily Bimini, New Providence, Andros, Eleuthera, Grand Bahama, Great Abaco, Great Inagua, Harbour, Long, Mayaguana and San Salvador islands.
BT	(675)	Bhutan		

Code		Text	Description	Observations
ALPHA-2	NUM			
1	2	3	4	5
BV	(892)	Bouvet Island		Under code XR (890) Polar regions until 2000. See code NO (028).
BW	(391)	Botswana		
BY	(073)	Belarus	Often referred to as Belorussia	Until 30 June 1992 Belarus appeared under code SU (056) USSR.
BZ	(421)	Belize		Including Ambergris Cay and Turneffe Islands.
CA	(404)	Canada		Including the Canadian Arctic Archipelago, of which the main islands are: Bank Island, Devon Island, Ellesmere Island, Parry Islands, Sverdrup Islands and Victoria Island.
CC	(833)	Cocos Islands (or Keeling Islands)		Under code XO (802) Australian Oceania until 2000. See code AU (800).
CD	(322)	Congo, Democratic Republic of	Formerly Zaire	
CF	(306)	Central African Republic		
CG	(318)	Congo		
CH	(039)	Switzerland	Including the German territory of Büsingen	Included the Italian municipality of Campione d'Italia until 2019. See code IT (005).
CI	(272)	Côte d'Ivoire	Often referred to as Ivory Coast	Officially called Côte d'Ivoire.
CK	(837)	Cook Islands		Under code XZ (814) New Zealand Oceania until 2000. Main Island: Rarotonga. See code NZ (804).
CL	(512)	Chile		Also including Chiloé Island, the Chonos Archipelago, Wellington Island, the western part of Tierra del Fuego, the Juan Fernández Islands, Easter Island, Sala y Gómez Island, San Ambrosio Island and San Félix Island.
CM	(302)	Cameroon		
CN	(720)	China		Including the island of Hainan. Hong Kong is a special administrative region of China since 1977, appearing under code HK (740).
CO	(480)	Colombia		Including Malpelo Island, San Andrés and Providencia Islands.
CR	(436)	Costa Rica		Including Coco Island.
CU	(448)	Cuba		Cuba consists of the main island (Cuba), the Camagüey, Sabana, Los Jardines de la Reina, Los Canarreosa and Los Colorados archipelagos and Juventud (formerly Pinos) Island.
CV	(247)	Cabo Verde		The archipelago comprises the islands of Santo Antão, São Vicente, Santa Luzia, Branco, Raso, São Nicolau, Sal, Boa Vista, Santiago, Brava, Fogo, Rombo and Maio.
CW	(475)	Curaçao		Under code AN (478) Netherlands Antilles until 2012. See code NL (003).
CX	(834)	Christmas Island		Under code XO (802) Australian Oceania until 2000. See code AU (800).
CY	(600)	Cyprus		
CZ	(061)	Czechia		Czechia and Slovakia formed Czechoslovakia until 1992.

Code		Text	Description	Observations
ALPHA-2	NUM			
1	2	3	4	5
DE	(004)	Germany	Including the island of Heligoland; excluding the territory of Büsingen	The territory of Büsingen is attached to Switzerland. See code CH (039).
DJ	(338)	Djibouti		
DK	(008)	Denmark		The main islands are Zealand, Funen, Lolland, Falster, Langeland, Møn and Bornholm. Two territories are located in the North Atlantic: the Faroe Islands appearing under code FO (041) and Greenland under code GL (406); they are thus not included in the statistical territory of Denmark.
DM	(460)	Dominica		
DO	(456)	Dominican Republic		Consists of the eastern part of the island of Hispaniola and Saona Island.
DZ	(208)	Algeria		
EC	(500)	Ecuador	Including the Galápagos Islands	The Galapagos Island principally includes San Cristobal Island and Isabela Island.
EE	(053)	Estonia		Baltic republic, independent since 1991. The islands of Saaremaa and Hiiumaa are part of the territory of Estonia.
EG	(220)	Egypt		
EH	(229)	Western Sahara		
ER	(336)	Eritrea		Including the Dahlak Archipelago.
ES	(011)	Spain	Including the Balearic Islands and the Canary Islands; excluding Ceuta (XC) and Melilla (XL)	The main islands comprising the Balearic Islands (located in the Mediterranean) are Majorca, Minorca, Ibiza and Formentera. The Canary Islands (Archipelago located in the Atlantic Ocean northwest of Western Sahara) comprise Tenerife, Fuerteventura, Gran Canaria, Lanzarote, La Palma, Gomera and Hierro and have been part of the statistical territory of Spain since 1997. XC (021) Ceuta and XL (023) Melilla (enclaves located in northwest Africa) are not included in the statistical territory of Spain.
ET	(334)	Ethiopia		
FI	(032)	Finland	Including the Åland Islands	The Åland Islands are also known as Ahvenanmaa.
FJ	(815)	Fiji		Viti Levu and Vanua Levu are the main islands; including Rotuma Island.
FK	(529)	Falkland Islands		Also called Malvinas Islands. Consisting primarily of West and East Falkland. See code GB (006).
FM	(823)	Micronesia, Federated States of	Chuuk, Kosrae, Pohnpei and Yap	Chuuk (formerly Truk). Also including Caroline Islands, excluding Palau Islands, see code PW (825). Independent since 1991. See code US (400).
FO	(041)	Faroe Islands		See code DK (008).

Code		Text	Description	Observations
ALPHA-2	NUM			
1	2	3	4	5
FR	(001)	France	Including Monaco, the French overseas departments (French Guiana, Guadeloupe, Martinique, Mayotte and Réunion) and the French northern part of St Martin	The overseas departments and the overseas territories form the 'French overseas communities'. Only the overseas departments belong to the statistical territory of the European Union, since 1997 for French Guiana, Guadeloupe, Martinique and Réunion and since 2014 for Mayotte. The overseas countries and territories are: BL (466) Saint Barthélemy, NC (809) New Caledonia, PF (822) French Polynesia, PM (408) Saint Pierre and Miquelon, TF (894) French Southern Territories and WF (811) Wallis and Futuna, and until 2013 YT (377) Mayotte. The island of Corsica is also part of the statistical territory of France.
GA	(314)	Gabon		
GB	(006)	United Kingdom	Great Britain, Northern Ireland, Channel Islands and Isle of Man	Northern Ireland is also called Ulster. The Channel Islands comprise Jersey, Guernsey, Alderney and Sark. The following territories, although dependent of the United Kingdom, appear under the following codes: AI (446) Anguilla, AQ (891) Antarctica, BM (413) Bermuda, FK (529) Falkland Islands, GI (044) Gibraltar, GS (893) South Georgia and South Sandwich Islands, IO (357) British Indian Ocean Territory, KY (463) Cayman Islands, MS (470) Montserrat, PN (813) Pitcairn, SH (329) Saint Helena, Ascension and Tristan da Cunha, TC (454) Turks and Caicos Islands and VG (468) Virgin Islands, British. See also codes XI (015) and XU (016) under Miscellaneous codes .
GD	(473)	Grenada	Including Southern Grenadines	The southern Grenadine Islands include Carriacou and Petit Martinique Islands.
GE	(076)	Georgia		Until 30 June 1992 Georgia appeared under code SU (056) USSR. Georgia comprises two autonomous republics, Abkhazia and Adjara, and an autonomous province, South Ossetia.
GH	(276)	Ghana		
GI	(044)	Gibraltar		See code GB (006).
GL	(406)	Greenland		Greenland has a status of internal autonomy. See code DK (008).
GM	(252)	Gambia		
GN	(260)	Guinea		Guinea includes the Los Islands off the capital, Conakry.
GQ	(310)	Equatorial Guinea		Equatorial Guinea consists of a mainland part, Mbini (formerly Rio Muni), an island part, Bioko Island (formerly Fernando Póo), Annobón Island (formerly Pagalu), Corisco Island and the Elobays Islands.
GR	(009)	Greece		
GS	(893)	South Georgia and South Sandwich Islands		Under code XR (890) Polar regions until 2000. See code GB (006).
GT	(416)	Guatemala		
GU	(831)	Guam		See code US (400).

Code		Text	Description	Observations
ALPHA-2	NUM			
1	2	3	4	5
GW	(257)	Guinea-Bissau		Comprises about 60 islands including the Bijagós Archipelago.
GY	(488)	Guyana		Formerly British Guiana.
HK	(740)	Hong Kong	Hong Kong Special Administrative Region of the People's Republic of China	Transfer of sovereignty to the People's Republic of China in 1997 Hong Kong principally includes Hong Kong Island, Lantau Island, the mainland peninsula of Kowloon and the New Territories.
HM	(835)	Heard Island and McDonald Islands		See code AU (800).
HN	(424)	Honduras	Including Swan Islands	Including the Bay islands.
HR	(092)	Croatia		Until 30 June 1992 Croatia appeared under code YU (048) Yugoslavia. See code SI (091).
HT	(452)	Haiti		Haïti consists of the western part of the island of Hispaniola and Île de la Gonâve, Île de la Tortue, Île à Vache and Grande Cayemite.
HU	(064)	Hungary		
ID	(700)	Indonesia		The archipelago comprises the islands of Sumatra, Java, Bali, Flores and the western part of Timor, part of Borneo (Kalimantan), Sulawesi (Celebes), the Moluccan Islands and the western part of New Guinea (Irian Jaya).
IE	(007)	Ireland		Also known as Eire.
IL	(624)	Israel		
IN	(664)	India		Including Laccadive Island, Minicoy Island, Amindivi Island, Andaman and Nicobar Islands.
IO	(357)	British Indian Ocean Territory	Chagos Archipelago	The Chagos Archipelago, a British territory since 1965, is also known as the Oil Islands. See code GB (006).
IQ	(612)	Iraq		
IR	(616)	Iran, Islamic Republic of		
IS	(024)	Iceland		
IT	(005)	Italy	Including Livigno and the municipality of Campione d'Italia	Including Elba, Sardinia, Sicily and the Italian waters of Lake Lugano. The statistical territory of Campione d'Italia was previously included in code CH (039) Switzerland until 2019.
JM	(464)	Jamaica		
JO	(628)	Jordan		
JP	(732)	Japan		Comprises four major islands: Hokkaido, Honshu, Shikoku and Kyushu.
KE	(346)	Kenya		
KG	(083)	Kyrgyzstan		Until 30 June 1992 Kyrgyzstan appeared under code SU (056) USSR.
KH	(696)	Cambodia		
KI	(812)	Kiribati		Archipelago comprising the Gilbert, Phoenix, a part of the Ligne Islands and Banaba Island (Ocean Island).
KM	(375)	Comoros	Anjouan, Grande Comore and Mohéli	Anjouan (Ndzouani), Grande-Comore (Ngazidja) and Mohéli (Moiili); the Archipelago includes a fourth island, Mayotte. See code YT (377).

Code		Text	Description	Observations
ALPHA-2	NUM			
1	2	3	4	5
KN	(449)	St Kitts and Nevis		Including the island of St Kitts (St Christopher) and island of Nevis.
KP	(724)	Korea, Democratic People's Republic of	Often referred to as North Korea	
KR	(728)	Korea, Republic of	Often referred to as South Korea	Including Cheju Island
KW	(636)	Kuwait		Including the islands of Boûbiyan, Warbah and Failakah.
KY	(463)	Cayman Islands		The archipelago includes Grand Cayman, Little Cayman and Cayman Brac. See code GB (006).
KZ	(079)	Kazakhstan		Until 30 June 1992 Kazakhstan appeared under code SU (056) USSR.
LA	(684)	Lao People's Democratic Republic	Often referred to as Laos	
LB	(604)	Lebanon		
LC	(465)	St Lucia		
LI	(037)	Liechtenstein		
LK	(669)	Sri Lanka		Formerly called Ceylon.
LR	(268)	Liberia		
LS	(395)	Lesotho		Landlocked in South Africa.
LT	(055)	Lithuania		Baltic republic, independent since 1991.
LU	(018)	Luxembourg		
LV	(054)	Latvia		Baltic republic, independent since 1991.
LY	(216)	Libya		
MA	(204)	Morocco		
MD	(074)	Moldova, Republic of		Until 30 June 1992 Moldova appeared under code SU (056) USSR.
ME	(097)	Montenegro		See code SI (091).
MG	(370)	Madagascar		Including Nosy-Be Island.
MH	(824)	Marshall Islands		Archipelago comprising the atoll Ratak and Ralik Islands. Independent state since 1989. See code US (400).
MK	(096)	North Macedonia		North Macedonia appeared under code YU (048) Yugoslavia until 30 June 1992 and under code YU (090) Yugoslavia from 1 July to 31 December 1992. It was one of the republics of the Socialist Federal Republic of Yugoslavia, together with Bosnia and Herzegovina, Croatia, Montenegro and Serbia, Slovenia.
ML	(232)	Mali		
MM	(676)	Myanmar	Often referred to as Burma	
MN	(716)	Mongolia		
MO	(743)	Macao	Special Administrative Region of the People's Republic of China	Former Portuguese overseas territory, located west of Hong Kong on the southeast coast of China. Returned to China in 1999.
MP	(820)	Northern Mariana Islands		The main islands are Saipan, Tinian and Rota. See code US (400).
MR	(228)	Mauritania		
MS	(470)	Montserrat		Part of the Leeward Islands of the Lesser Antilles. See code GB (006).

Code		Text	Description	Observations
ALPHA-2	NUM			
1	2	3	4	5
MT	(046)	Malta	Including Gozo and Comino	The archipelago consists of the islands of Gozo, Comino, Cominotto and Filfofa.
MU	(373)	Mauritius	Mauritius, Rodrigues Island, Agalega Islands and Cargados Carajos Shoals (St Brandon Islands)	
MV	(667)	Maldives		
MW	(386)	Malawi		
MX	(412)	Mexico		
MY	(701)	Malaysia	Peninsular Malaysia and Eastern Malaysia (Labuan, Sabah and Sarawak)	Eastern Malaysia is located on the northwest coast of Borneo.
MZ	(366)	Mozambique		
NA	(389)	Namibia		Independent since 1990; before that date it was part of the territory of South Africa.
NC	(809)	New Caledonia	Including Loyalty Islands (Lifou, Maré and Ouvéa)	Including the Belep Islands and the Isle of Pines. See code FR (001).
NE	(240)	Niger		
NF	(836)	Norfolk Island		See code AU (800).
NG	(288)	Nigeria		
NI	(432)	Nicaragua	Including Corn Islands	
NL	(003)	Netherlands		The autonomous island territories in the Caribbean which are part of the Kingdom appear under the following codes: AW (474) Aruba; BQ (477) Bonaire, Sint Eustatius and Saba; CW (475) Curaçao; and SX (479) Sint Maarten (Dutch part).
NO	(028)	Norway	Including Svalbard Archipelago and Jan Mayen Island	The Svålbard Archipelago consists of Spitsbergen, North-East Land, Barents Island, Edge Island, Prince Charles Island, King Charles Island and Bear Island. Bouvet Island appears under code BV (892), Peter 1st Island and Queen Maud Land appear under code AQ (891).
NP	(672)	Nepal		
NR	(803)	Nauru		
NU	(838)	Niue		See code NZ (804).
NZ	(804)	New Zealand	Excluding Ross Dependency (Antarctica)	Including the Chatham Islands, the Kermadec Group and the Three Kings, Auckland, Campbell, Antipodes, Bounty and Snares Islands. The following islands, although administered by New Zealand, appear under the following codes: CK (837) Cook Islands, NU (838) Niue and TK (839) Tokelau.
OM	(649)	Oman		Including part of the Moussandam peninsula.
PA	(442)	Panama	Including former Canal Zone	Comprises the Las Perlas Archipelago and Coiba Island.
PE	(504)	Peru		
PF	(822)	French Polynesia	Marquesas Islands, Society Islands (including Tahiti), Tuamotu Islands, Gambier Islands and Austral Islands.	Society Islands Archipelago (of which Tahiti is the most important island) comprises the Leeward and Windward island groups. Gambier Islands (main island: Mangareva). The Austral Islands comprise Tubuai, Rimatara, Rurutu, Raivavae and Rapa. See code FR (001).

Code		Text	Description	Observations
ALPHA-2	NUM			
1	2	3	4	5
PG	(801)	Papua New Guinea	Eastern part of New Guinea; Bismarck Archipelago (including New Britain, New Ireland, Lavongai (New Hanover) and Admiralty Islands); Northern Solomon Islands (Bougainville and Buka); Trobriand Islands, Woodlark Island; d'Entrecasteaux Islands and Louisiade Archipelago.	
PH	(708)	Philippines		The main islands are Luzon, Mindanao, Mindoro, Palawan and the Archipelago of Visayas.
PK	(662)	Pakistan		
PL	(060)	Poland		
PM	(408)	St Pierre and Miquelon		French territorial community under specific status. See code FR (001).
PN	(813)	Pitcairn	Including the Ducie, Henderson and Oeno Islands	Under the jurisdiction of the British High Commissioner to New Zealand. See code GB (006).
PS	(625)	Occupied Palestinian Territory	West Bank (including East Jerusalem) and Gaza Strip	
PT	(010)	Portugal	Including Azores and Madeira	The archipelago of the Azores comprises nine islands: São Miguel, Santa Maria, Terceira, Graciosa, São Jorge, Pico, Faial, Flores and Corvo. Madeira also includes the Porto Santo Island.
PW	(825)	Palau		Palau consists of the western part of the Carolines islands and comprises 26 islands, including Koror and the Babelthuap. See code US (400).
PY	(520)	Paraguay		
QA	(644)	Qatar		
RO	(066)	Romania		
RU	(075)	Russian Federation	Often referred to as Russia	The Russian Federation corresponds to the former Russian Soviet Federal Socialist Republic. It also includes: the enclave of Kaliningrad; Franz Josef Land, Novaya Zemlya, Severnya Zemlya, the New Siberian Islands and Wrangel Island in the Arctic Ocean; the Kuril Islands; and Sakhalin Island in the Pacific Ocean.
RW	(324)	Rwanda		
SA	(632)	Saudi Arabia		
SB	(806)	Solomon Islands		Comprises South Solomon Islands and Santa Cruz Islands.
SC	(355)	Seychelles	Mahé Island, Praslin Island, La Digue, Frégate and Silhouette; Amirante Islands (including Desroches, Alphonse, Platte and Coëtivy); Farquhar Islands (including Providence); Aldabra Islands and Cosmoledo Islands.	Archipelago of 115 isles and islands.
SD	(224)	Sudan		See code SS (225).
SE	(030)	Sweden		Also including the islands of Gotland and Öland.
SG	(706)	Singapore		

Code		Text	Description	Observations
ALPHA-2	NUM			
1	2	3	4	5
SH	(329)	Saint Helena, Ascension and Tristan da Cunha		The other islands of the Tristan da Cunha Archipelago are Gough, Inaccessible and Nightingale. See code GB (006).
SI	(091)	Slovenia		Until 30 June 1992 Slovenia appeared under code YU (048) Yugoslavia. It was one of the republics of the Socialist Federal Republic of Yugoslavia, together with Bosnia and Herzegovina, Croatia, Macedonia, Montenegro and Serbia.
SK	(063)	Slovakia		Czechia and Slovakia formed Czechoslovakia until 1992.
SL	(264)	Sierra Leone		Including Sherbro Island.
SM	(047)	San Marino		Landlocked state in Italy.
SN	(248)	Senegal		Including the island of Gorée.
SO	(342)	Somalia		
SR	(492)	Suriname		Formerly Dutch Guiana.
SS	(225)	South Sudan		Under code SD (224) Sudan until 2012. South Sudan, officially the Republic of South Sudan, gained its independence from Sudan in 2011 following a referendum.
ST	(311)	Sao Tome and Principe		Comprises São Tomé Island and Príncipe Island and the small islands of Pedras Tinhosas and Rolas.
SV	(428)	El Salvador		
SX	(479)	Sint Maarten (Dutch part)	The island of Saint Martin is divided into the French northern part and the Dutch southern part.	Under code AN (478) Netherlands Antilles until 2012. See code NL (003).
SY	(608)	Syrian Arab Republic	Often referred to as Syria	
SZ	(393)	Eswatini	Formerly Swaziland	Also called Ngwane.
TC	(454)	Turks and Caicos Islands		The Turks Islands consist primarily of Grand Turk and Salt Cay. See code GB (006).
TD	(244)	Chad		
TF	(894)	French Southern Territories	Including Kerguelen Islands, Amsterdam Island, Saint-Paul Island, Crozet Archipelago and French scattered Indian Ocean Islands formed by Bassas da India, Europa Island, Glorioso Islands, Juan de Nova Island and Tromelin Island.	See code FR (001).
TG	(280)	Togo		
TH	(680)	Thailand		
TJ	(082)	Tajikistan		Until 30 June 1992 Tajikistan appeared under code SU (056) USSR.
TK	(839)	Tokelau		See code NZ (804).
TL	(626)	Timor-Leste		
TM	(080)	Turkmenistan		Until 30 June 1992 Turkmenistan appeared under code SU (056) USSR.

Code		Text	Description	Observations
ALPHA-2	NUM			
1	2	3	4	5
TN	(212)	Tunisia		Including the island of Djerba.
TO	(817)	Tonga		Consists primarily of the Vava'u and Niuaus Islands, the Ha'apai and Tongatapu and Eua Islands.
TR	(052)	Türkiye ²		
TT	(472)	Trinidad and Tobago		
TV	(807)	Tuvalu		The main atoll: Funafuti.
TW	(736)	Taiwan	Separate customs territory of Taiwan, Penghu, Kinmen and Matsu	Formerly Formosa. Including the Pescadores or Penghu Islands, Quemoy or Kinmen Island and Matsu Island.
TZ	(352)	Tanzania, United Republic of	Pemba, Zanzibar Island and Tanganyika	The main islands are Zanzibar, Pemba et Mafia. Tanganyika is the mainland part of Tanzania.
UA	(072)	Ukraine		Until 30 June 1992 Ukraine appeared under code SU (056) USSR.
UG	(350)	Uganda		
UM	(832)	United States Minor Outlying Islands	Including Baker Island, Howland Island, Jarvis Island, Johnston Atoll, Kingman Reef, Midway Islands, Navassa Island, Palmyra Atoll and Wake Island	Navassa Island was previously included in code XA (810) until 1994, and from 1995 until 2000 in code US (400). It is situated in the Antillean Sea (Atlantic Ocean), the other Islands are situated in the Pacific Ocean.
US	(400)	United States	Including Puerto Rico	Including Alaska and the Hawaiian Islands, and from 1995 until 2000 Navassa Island (which appeared under code XA (810) until 1994). The USA is responsible for the following territories: Puerto Rico, the Marshall Islands MH (824), the Federated States of Micronesia FM (823), Palau PW (825) and the Northern Mariana Islands MP (820); states in "free association" with the USA; American Samoa AS (830), Guam GU (831), United States Minor outlying islands UM (832), the US Virgin Islands VI (457); unincorporated territories of the USA. Puerto Rico comprises the islands of Puerto Rico, Mona, Vieques and Culebra.
UY	(524)	Uruguay		
UZ	(081)	Uzbekistan		Until 30 June 1992 Uzbekistan appeared under code SU (056) USSR.
VA	(045)	Holy See	Vatican City State	Is not included in the statistical territory of Italy
VC	(467)	St Vincent and the Grenadines		Comprises St Vincent Island and the northern Grenadine Islands (Bequia, Canouan, Mustique, Mayreau and Union Islands).

² The code TR corresponds to Turkey according to the latest version of the Geonomenclature ([Commission Implementing Regulation \(EU\) 2020/1470 of 12 October 2020](#)). However, since 7 October 2022, the European Union officially uses 'Türkiye' to refer to code TR in English.

Code		Text	Description	Observations
ALPHA-2	NUM			
1	2	3	4	5
VE	(484)	Venezuela, Bolivarian Republic of	Often referred to as Venezuela	Including Aves Island.
VG	(468)	Virgin Islands, British		Archipelago in the Lesser Antilles consisting primarily of Tortola, Virgin Gorda, Anegada, Jost Van Dyke, Peter and Salt Islands. See code GB (006).
VI	(457)	Virgin Islands, United States		The three main islands are St Thomas, St John and St Croix. See code US (400).
VN	(690)	Viet Nam		
VU	(816)	Vanuatu		The main islands are Santo, Malekula, Efate and Tanna.
WF	(811)	Wallis and Futuna	Including Alofi Island	Uvea is the biggest of the Wallis Islands. Futuna and Alofi comprise the Horn Islands. See code FR (001).
WS	(819)	Samoa	Formerly known as Western Samoa	Archipelago comprising primarily the Savai'i, Upolu, Apolima and Manono Islands.
XC	(021)	Ceuta		See code ES (011).
XK	(095)	Kosovo	This designation is without prejudice to positions on status, and is in line with UNSCR 1244/1999 and the ICJ Opinion on the Kosovo declaration of independence	
XL	(023)	Melilla	Including Peñón de Vélez de la Gomera, Peñón de Alhucemas and Chafarinas Islands.	See code ES (011).
XS	(098)	Serbia		Serbia administers the autonomous province of Voïvodine. See code SI (091).
YE	(653)	Yemen	Formerly North Yemen and South Yemen	Including the islands of Kamaran, Perim and Socotra.
ZA	(388)	South Africa		Including Marion Island and Prince Edouard Island.
ZM	(378)	Zambia		
ZW	(382)	Zimbabwe		

3.3.2. MISCELLANEOUS CODES

Code		Text	Description	Observations
ALPHA-2	NUM			
1	2	3	4	5
MISCELLANEOUS				
EU	(999)	European Union	Code reserved, in extra-Union trade, for the declaration of the origin of goods according to the conditions laid down in the relevant Union provisions. Code not to be used for statistical purposes.	
XI	(015)	United Kingdom (Northern Ireland)	Code to be used if United Kingdom (in respect of Northern Ireland) needs to be distinguished according to the conditions laid down in the relevant Union provisions.	
XU	(016)	United Kingdom (excluding Northern Ireland)	Code to be used if United Kingdom (excluding Northern Ireland) needs to be distinguished according to the conditions laid down in the relevant Union provisions.	
QP	(955)	High seas	Maritime domain outside of territorial waters	Code to be used to cover transactions involving installations on the high seas (oil platforms, wind farms, transoceanic cables).
QQ	(950)	Stores and provisions	Code for the purpose of deliveries to vessels and aircraft	Delivery of ships' and aircraft's stores. Ships' and aircraft's stores means the various products for consumption by the crew and passengers of vessels or aircraft. Ships' and aircraft's supplies means the products for the operation of the engines, machines and other equipment on vessels or aircraft, such as fuel, oil and lubricants.
or				
QR	(951)	Stores and provisions within the framework of intra-Union trade	Code for the purpose of deliveries to vessels and aircraft	If the type of trade can be determined (intra-EU trade or trade with non-EU countries), code QR (951) or QS (952) is used. Only if that is not the case, can code QQ (950) be used.
QS	(952)	Stores and provisions within the framework of extra-Union trade	Code for the purpose of deliveries to vessels and aircraft	

Code		Text	Description	Observations
ALPHA-2	NUM			
1	2	3	4	5
QU	(958)	Countries and territories not specified		If the type of trade can be determined (intra-EU trade or trade with non-EU countries), code QV (959) or QW (960) is used. Only if that is not the case, can code QU (958) be used.
	or			
	QV	(959)	Countries and territories not specified within the framework of intra-Union trade	
QW	(960)	Countries and territories not specified within the framework of extra-Union trade		
QX	(977)	Countries and territories not specified for commercial or military reasons		If the type of trade can be determined (intra-EU trade or trade with non-EU countries), code QY (978) or QZ (979) is used. If it cannot be determined for confidential commercial or military reasons, code QX (977) can be used.
	or			
	QY	(978)	Countries and territories not specified for commercial or military reasons in the framework of intra-Union trade	
QZ	(979)	Countries and territories not specified for commercial or military reasons in the framework of extra-Union trade		

Tips for Comext users

- The codes QP, QQ, QU and QX do not distinguish between EU Member States and non-EU countries. This implies that, theoretically, the trade reported with those partner codes cannot be allocated either to intra-EU trade or to extra-EU trade. In order to maintain the principle according to which, at Member State level, the trade with the world corresponds to the aggregation of intra- and extra-EU trade, those four codes are allocated to the extra-EU partner zone in the data dissemination.
- The trade reported with the United Kingdom as partner country is available under the code GB. Since 1 February 2020, GB has been an extra-EU partner. However, the implementation of the Protocol on Ireland/Northern Ireland starting with 1 January 2021 requires special compilation measures, making it possible to distinguish between United Kingdom (in respect of Northern Ireland – code XI) and United Kingdom (excluding Northern Ireland – code XU). While most datasets present aggregated data under the single code GB, one dataset dedicated to *EU trade since 2021 with the United Kingdom* as partner country (code GB) provides the Comext users with the trade values for the three partner codes GB, XI and XU.

4

Development of the codes

This chapter illustrates how the country codes have evolved over the last decades, from 1976 to the current year.

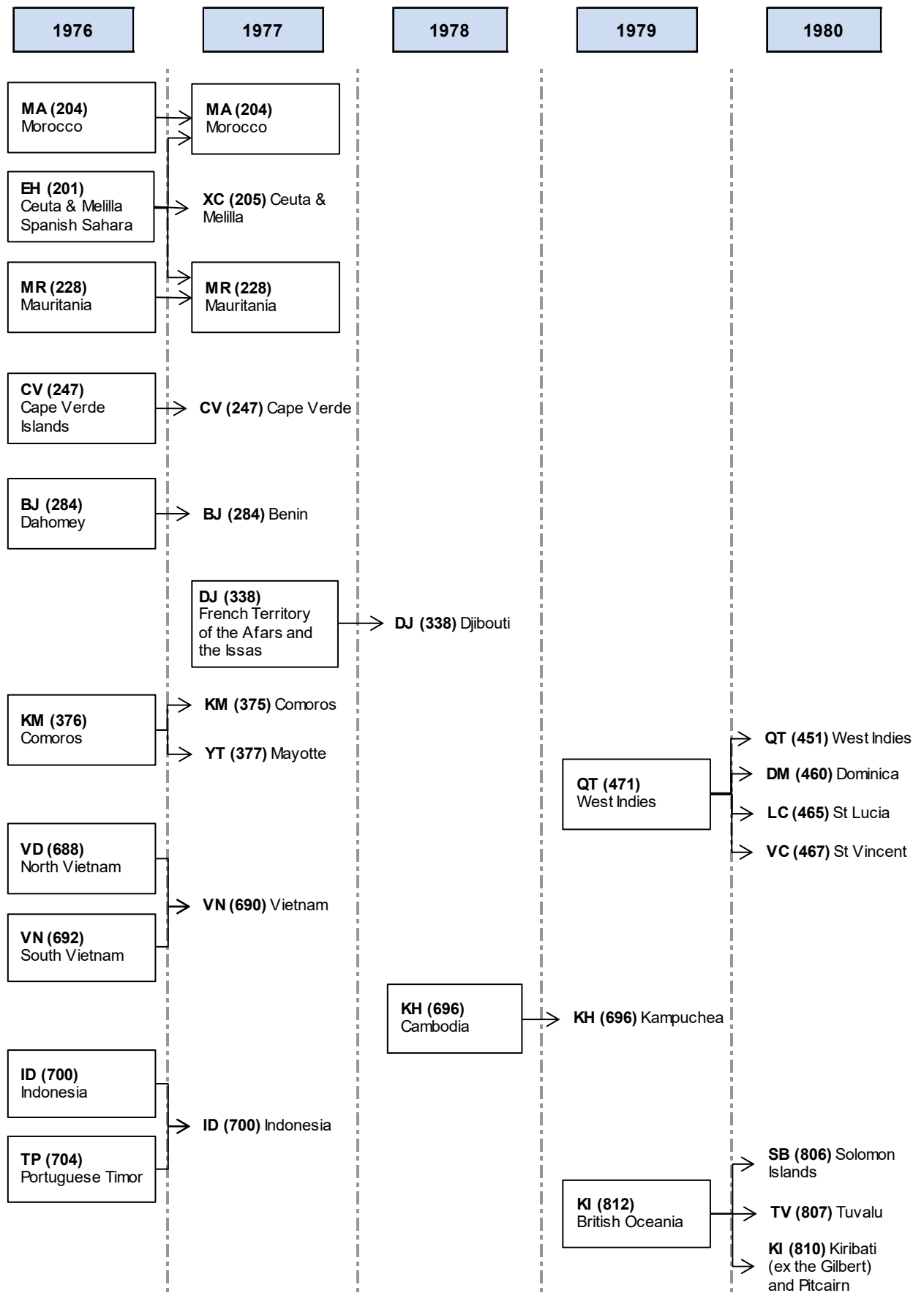

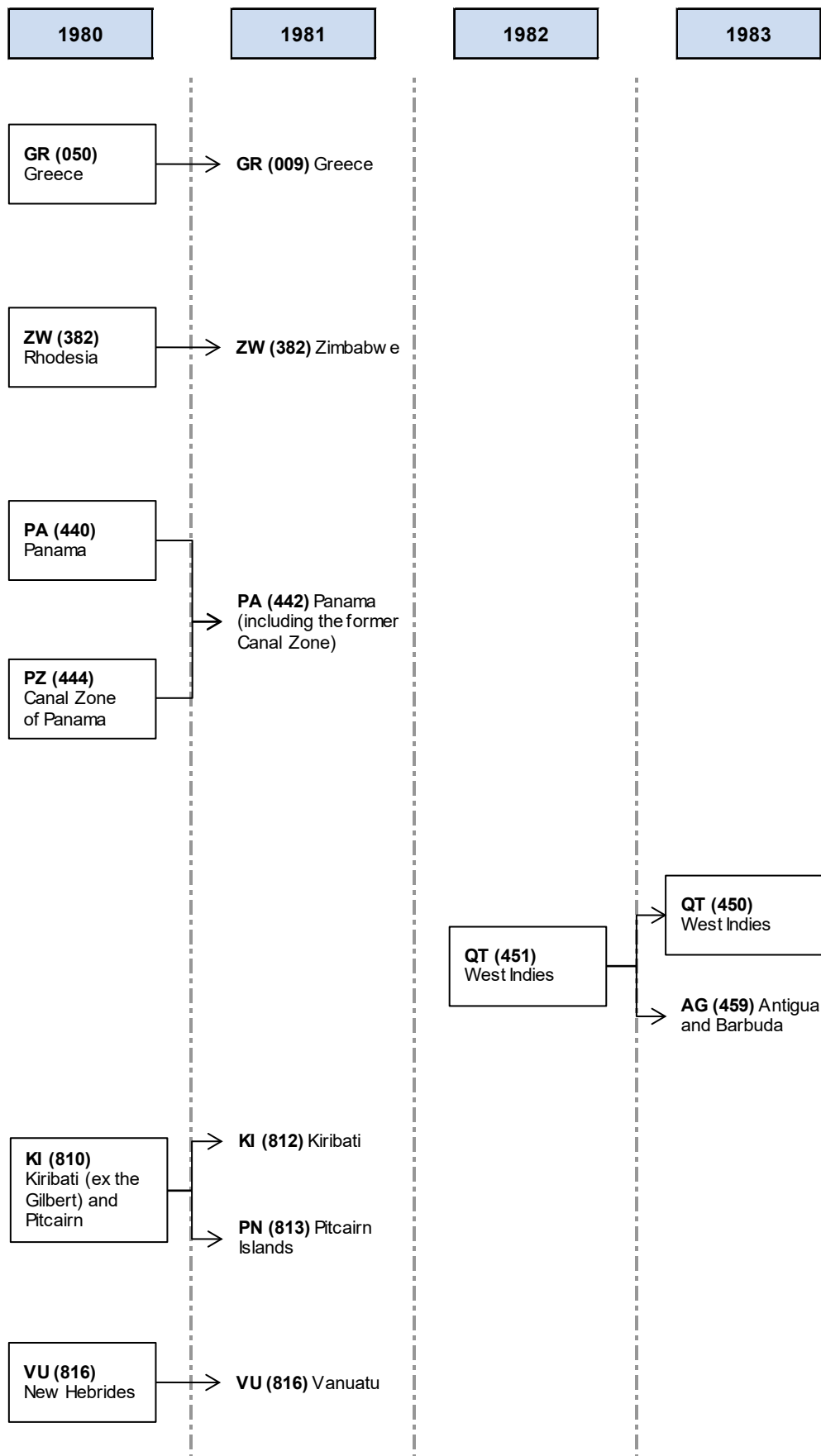

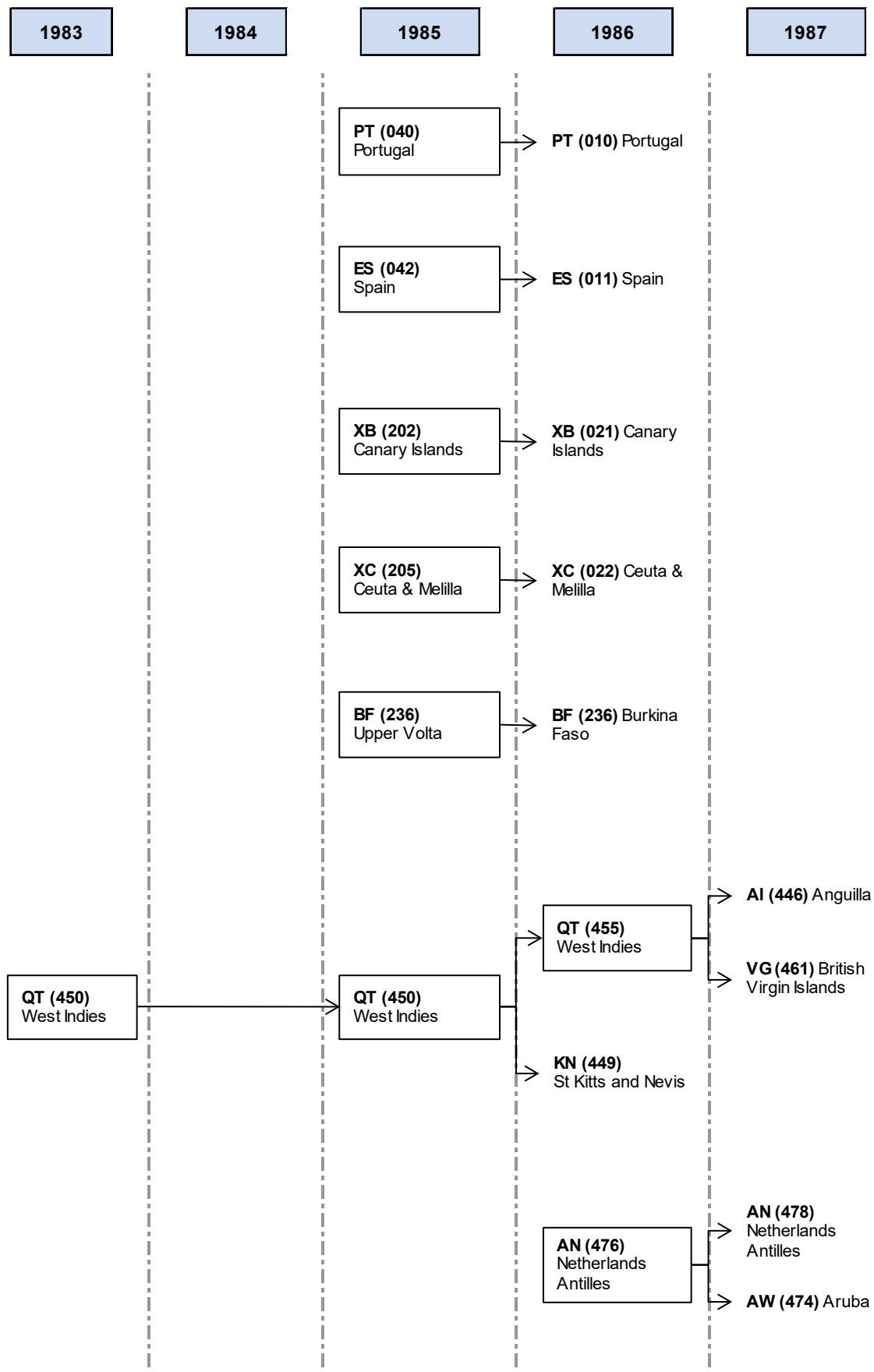

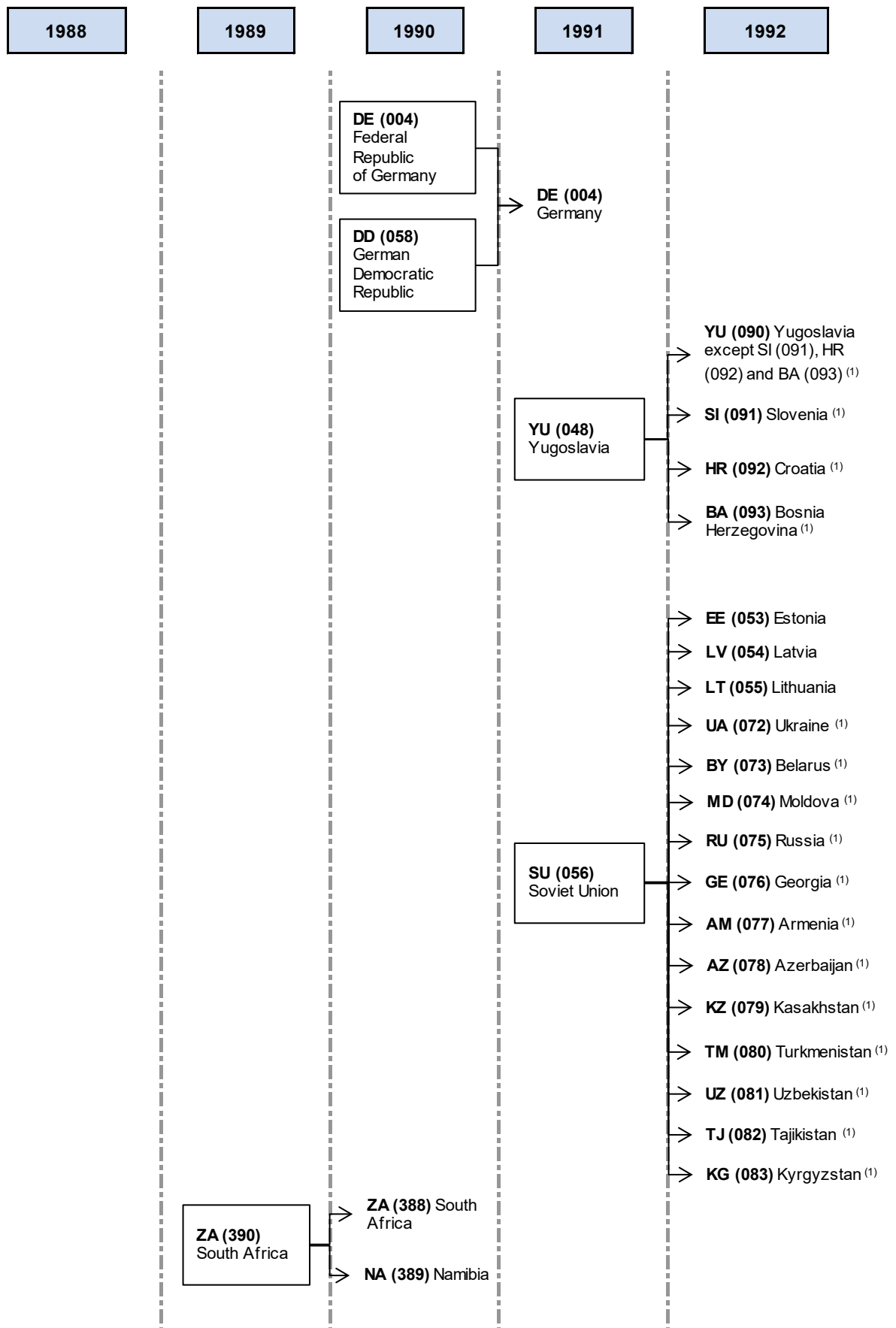

(1) From 01/07/1992

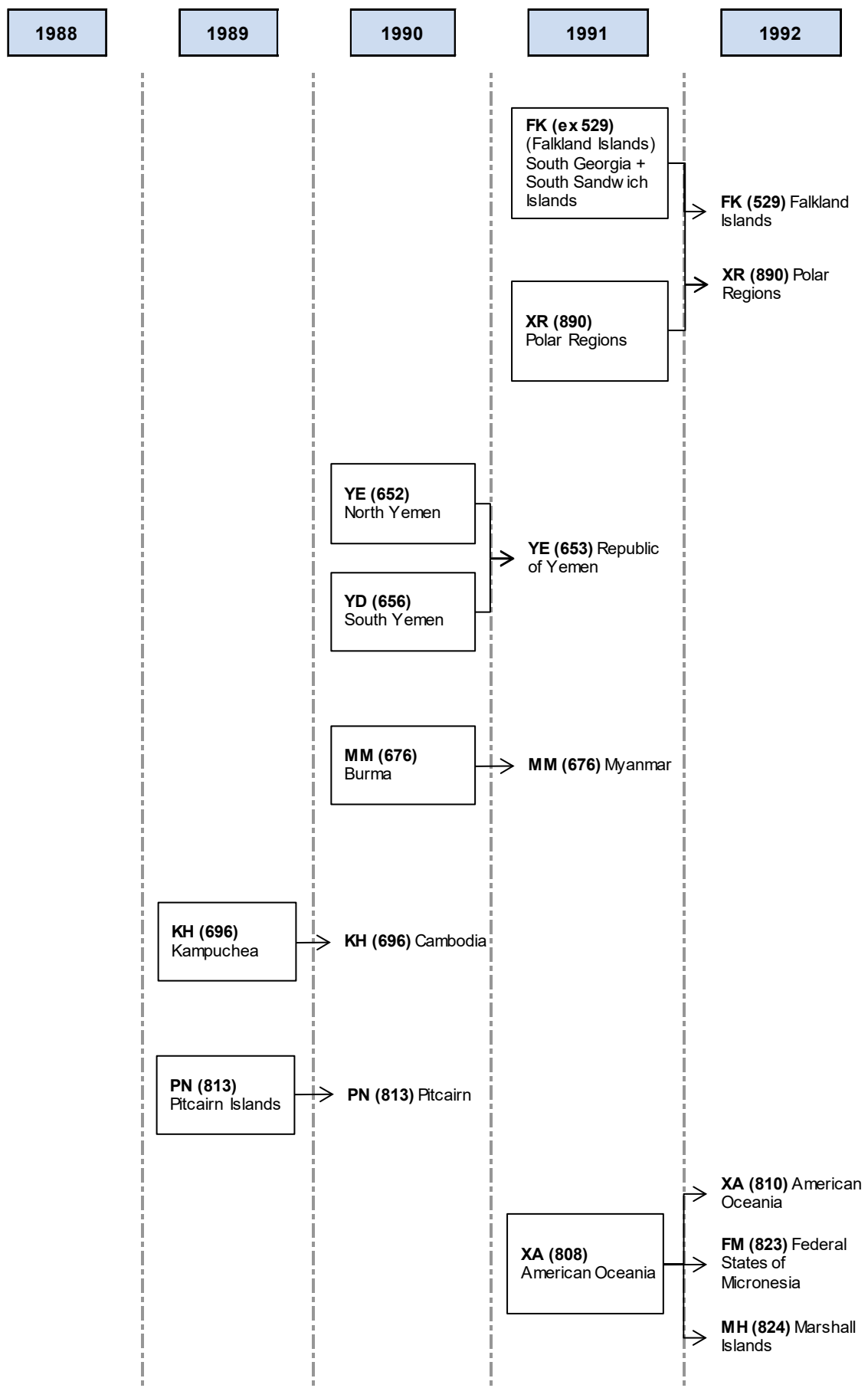

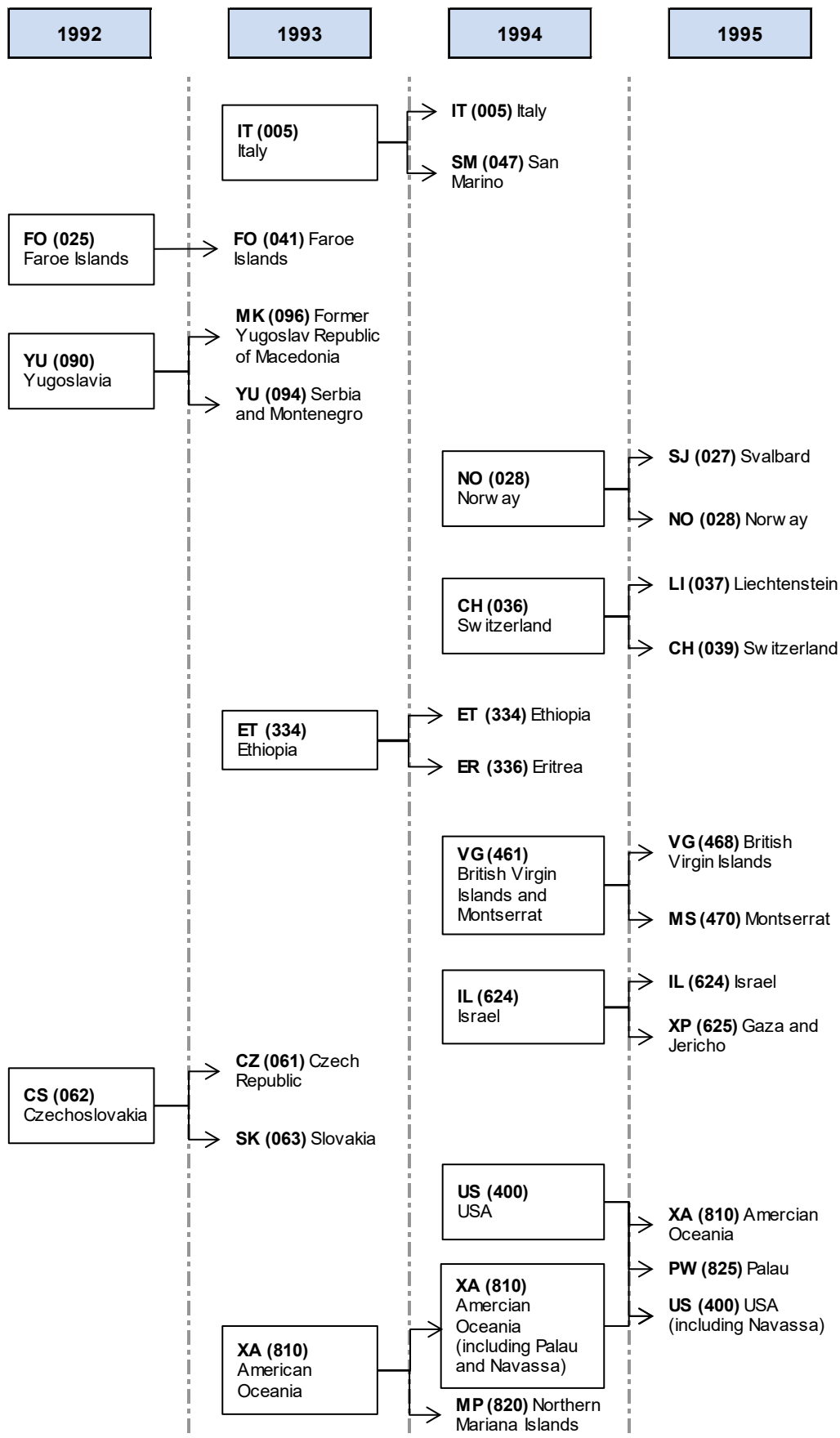

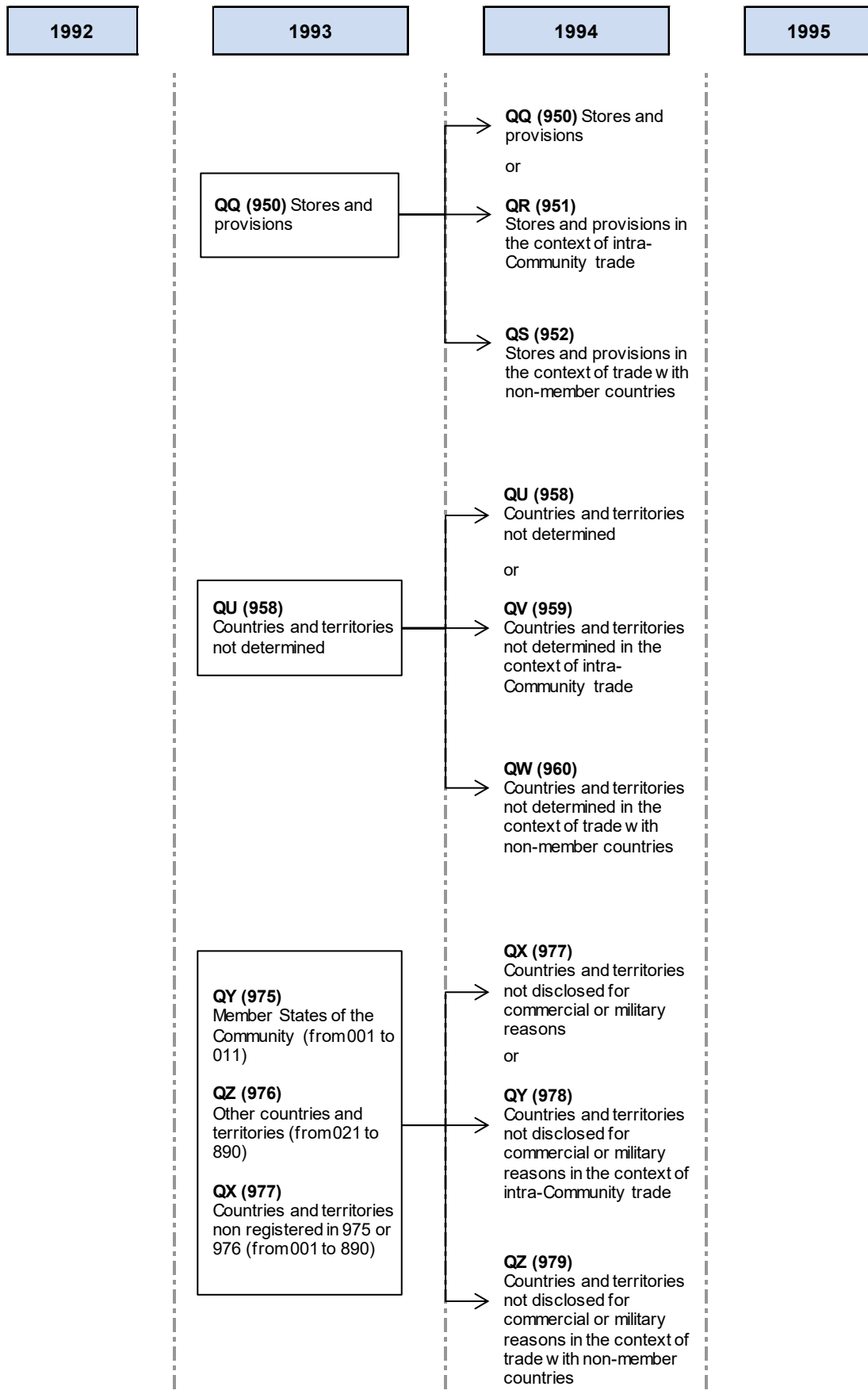

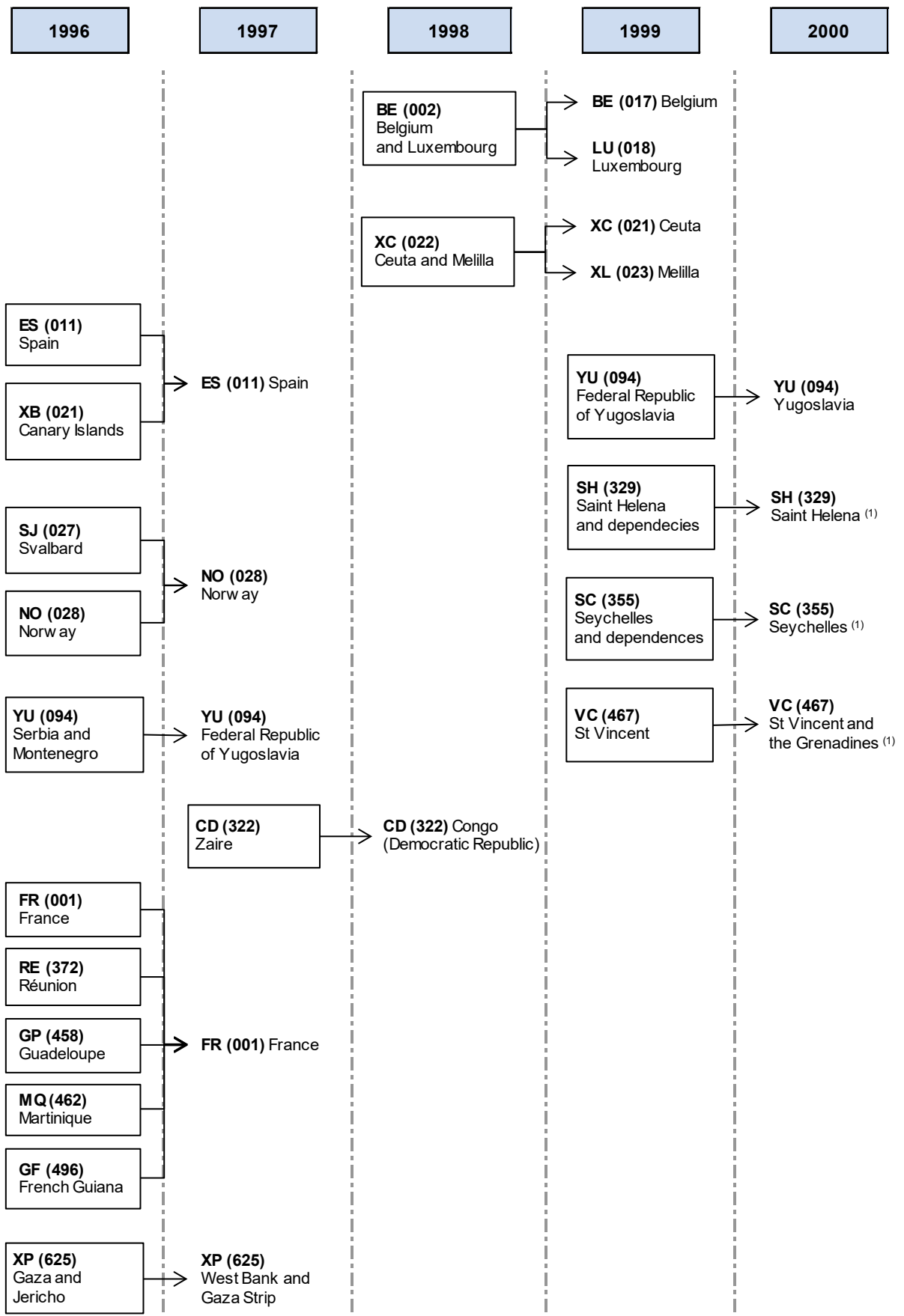

(1) The modification of the text has no impact on the validity of the code

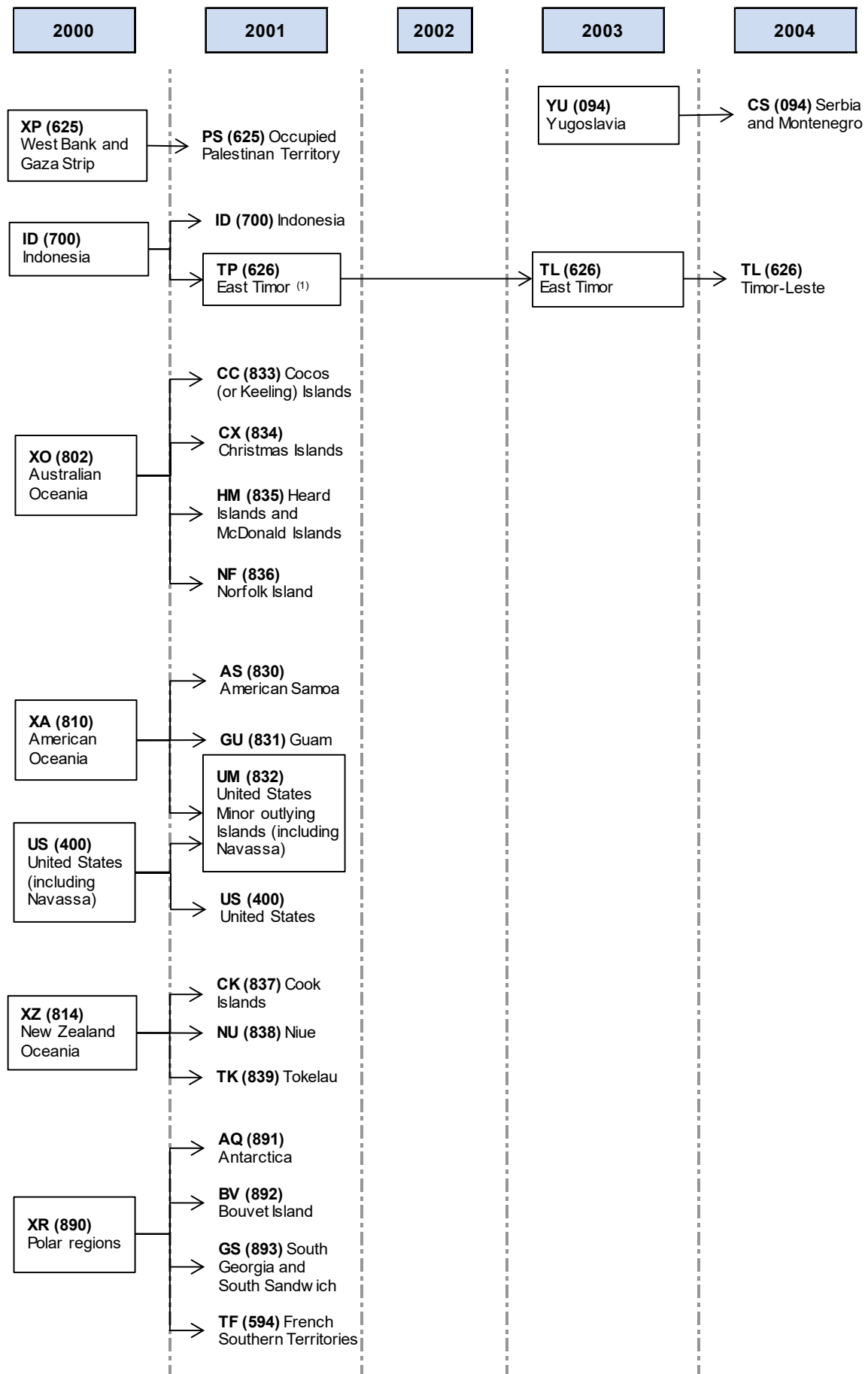

(1) Territory under United Nations transitoriel administration

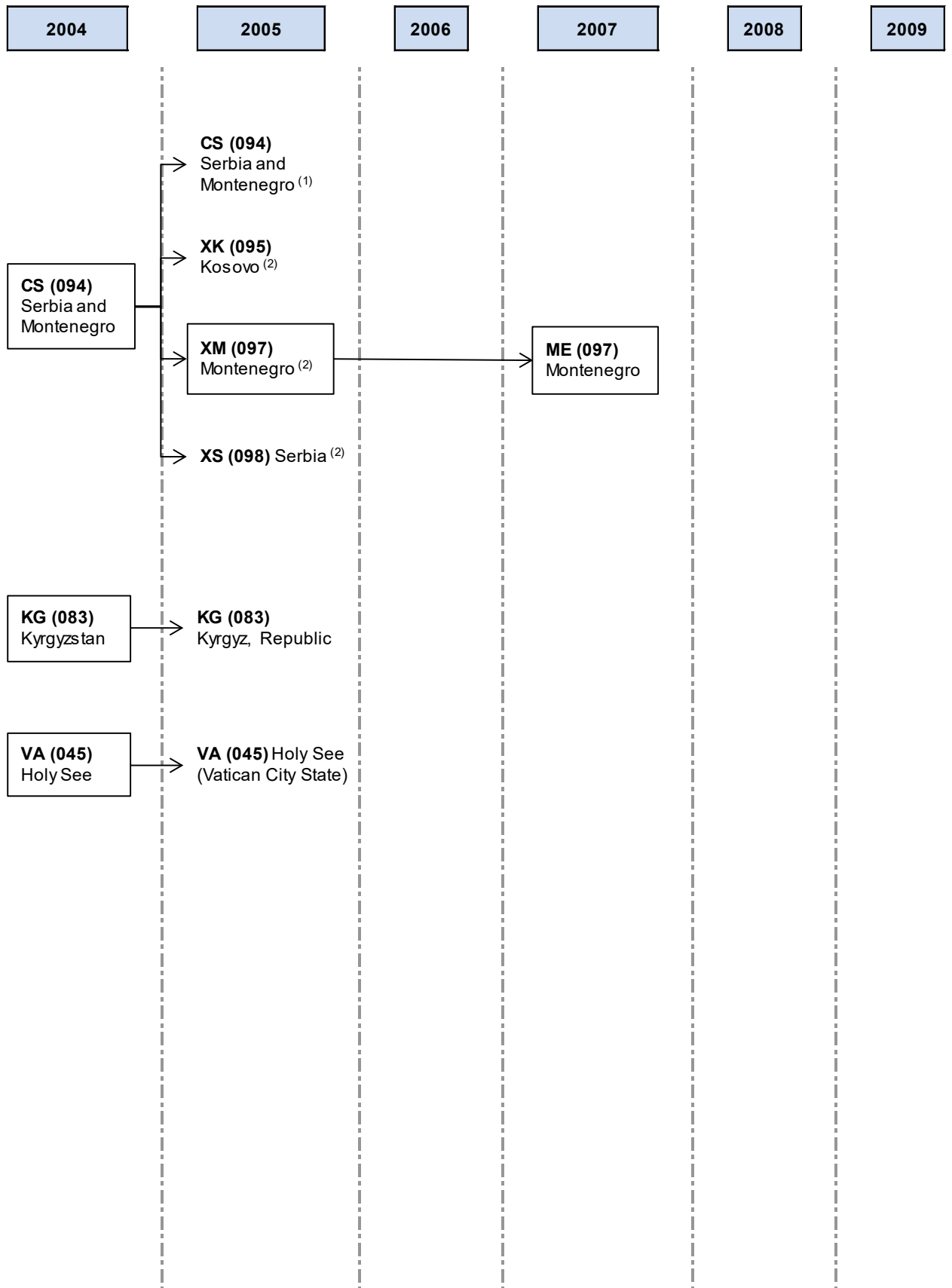

(1) Until 31/05/2005
 (2) From 01/06/2005

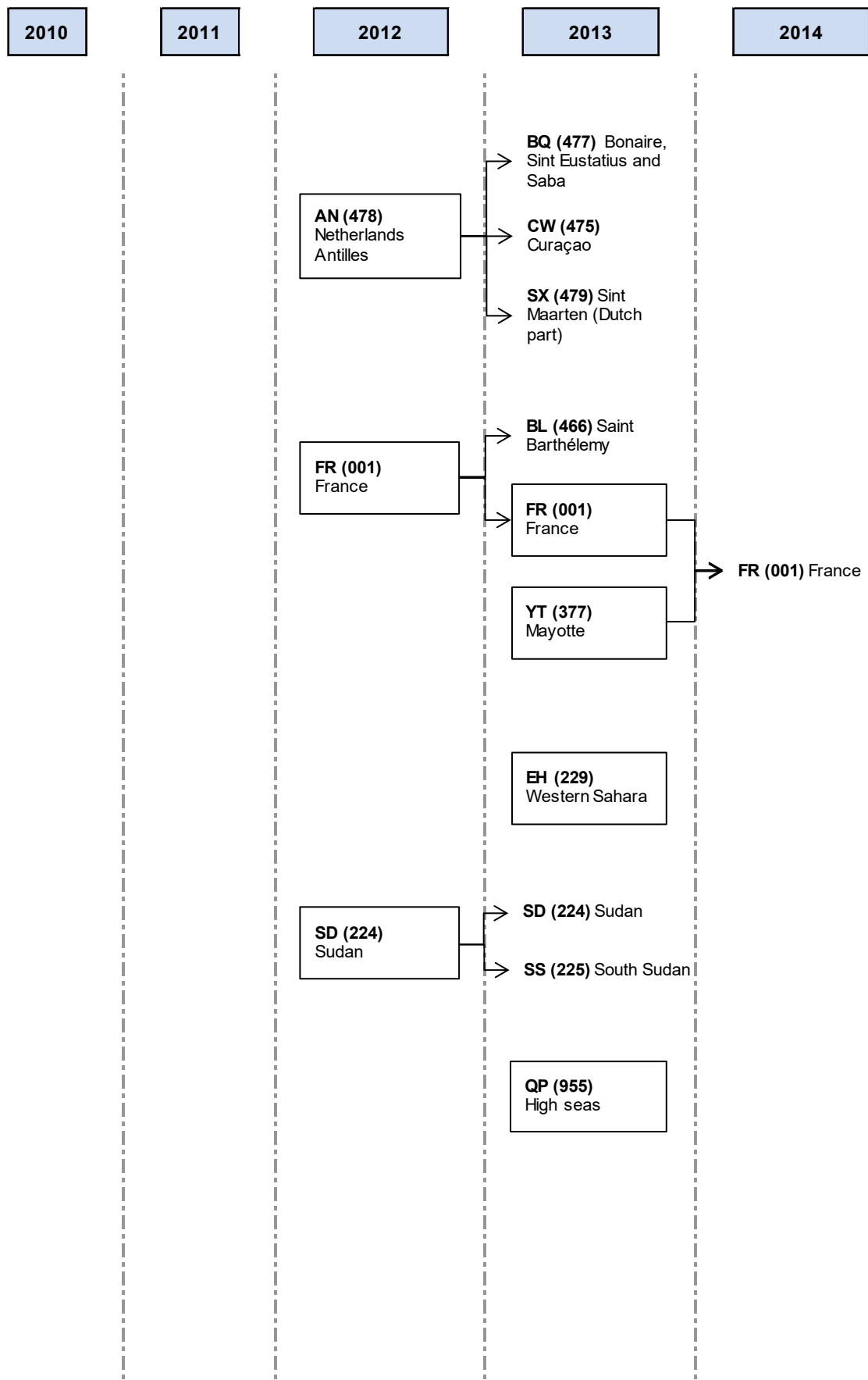

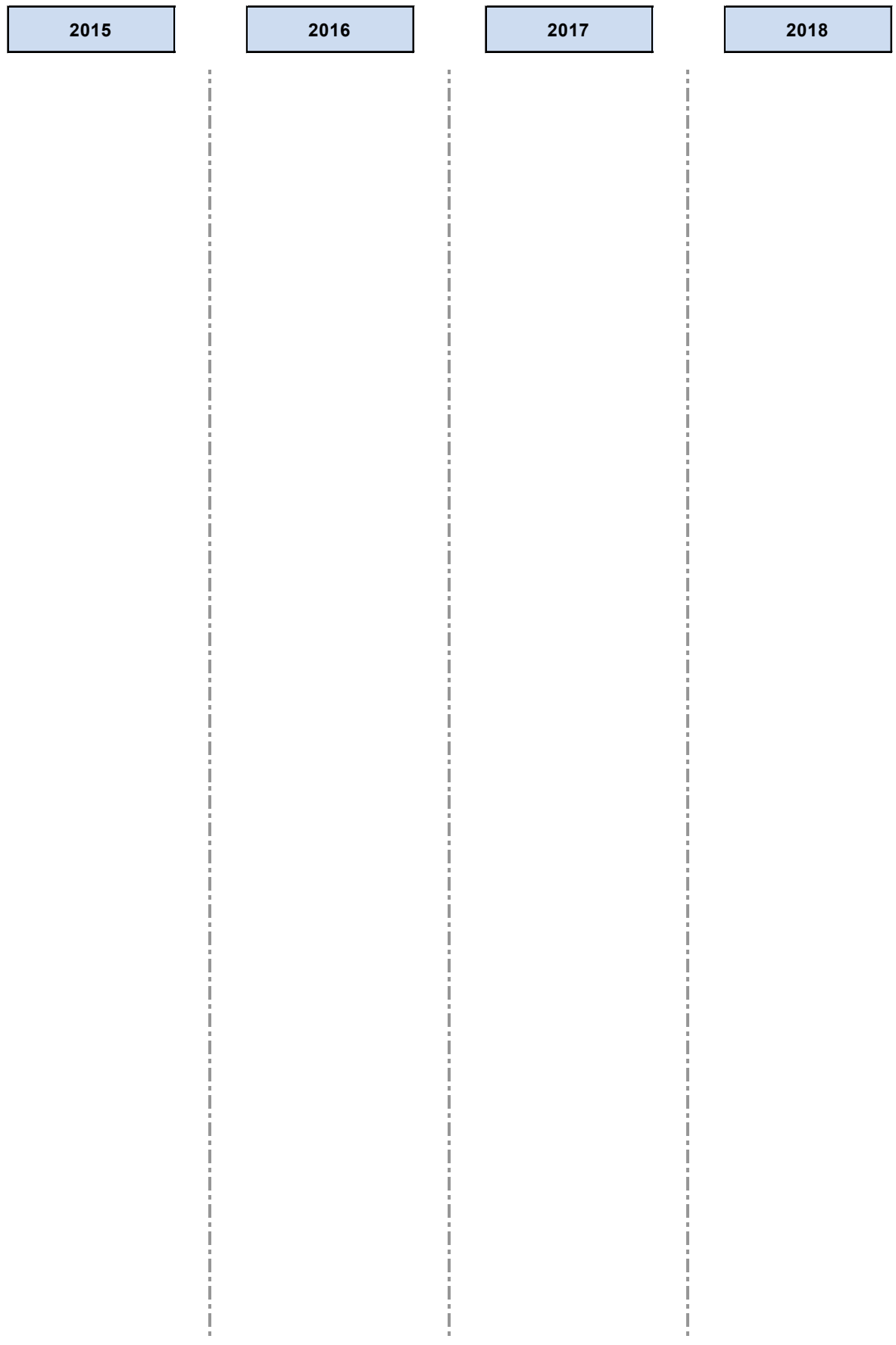

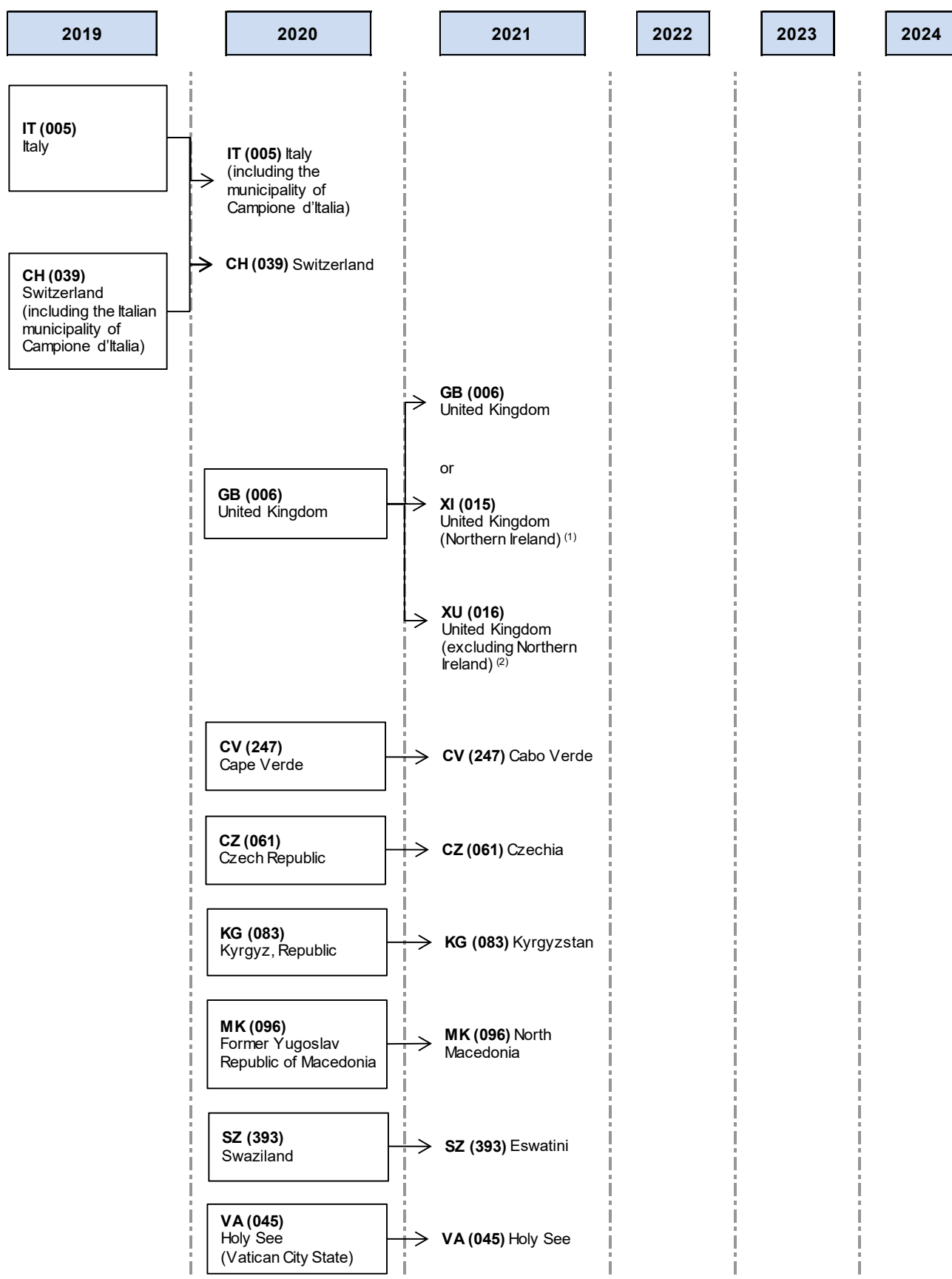

(1) Code to be used if United Kingdom (in respect of Northern Ireland) needs to be distinguished according to the conditions laid down in the relevant Union provisions.
 (2) Code to be used if United Kingdom (excluding Northern Ireland) needs to be distinguished according to the conditions laid down in the relevant Union provisions.

5

Economic zones

5.1. Changes since 2007

Economic zones		Changes	
2024			
1053	OPEC — Organisation of Petroleum Exporting Countries	- AO	(330) Angola
1130	Candidate countries	+ GE	(076) Georgia
1330	MERCOSUR — South American Common Market	+ BO	(516) Bolivia, Plurinational State of
1430	LDC — Least Developed Countries	- BT	(675) Bhutan
2023			
1013	Euro area since 1999 (evolutionary definition)	Modified title: 'Euro-zone since 1999 (evolutionary definition)' replaced by 'Euro area since 1999 (evolutionary definition)' + HR (092) Croatia	
1014	Extra-euro area since 1999 (evolutionary definition)	Modified title: 'Extra-euro-zone since 1999 (evolutionary definition)' replaced by 'Extra-euro area since 1999 (evolutionary definition)' - HR (092) Croatia	
1055	UfM — Union for the Mediterranean (excluding EU)	Modified title: 'MEDA — Union for the Mediterranean (excluding EU)' replaced by 'UfM — Union for the Mediterranean (excluding EU)' ³ + MK (096) North Macedonia	

³ The Union for the Mediterranean (UfM) is an intergovernmental organisation bringing together the EU countries and 16 countries of the Southern and Eastern Mediterranean (Albania, Algeria, Bosnia and Herzegovina, Egypt, Israel, Jordan, Lebanon, Mauritania, Monaco, Montenegro, Morocco, North Macedonia, Palestine, Syria (currently suspended), Tunisia and Türkiye). It was launched in 2008. The MEDA programme is its main financial instrument, set up by Council Regulation (EC) No 1488/96 of 23 July 1996. MEDA comes from '**MEsures D'Accompagnement financières et techniques** à la réforme des structures économiques et sociales dans le cadre du partenariat euro-méditerranéen' (French for '**financial and technical measures to accompany** the reform of economic and social structures in the framework of the Euro-Mediterranean partnership').

Economic zones		Changes	
1130	Candidate countries	+ BA (093)	Bosnia and Herzegovina
		+ MD (074)	Moldova, Republic of
		+ UA (072)	Ukraine
2019	Euro area (19)	Modified title: 'Euro-zone (19)' replaced by 'Euro area (19)'	
2020	Euro area (20)	2019 Euro area (19)	
		+ HR (092)	Croatia
2119	Extra-euro area (19)	Modified title: 'Extra-euro-zone (19)' replaced by 'Extra-euro area (19)'	
2120	Extra-euro area (20)	2119 Extra-euro area (19)	
		- HR (092)	Croatia
2022			
1820	OECD (excluding EU)	+ CR (436)	Costa Rica
2021			
1053	OPEC — Organisation of Petroleum Exporting Countries	- EC (500)	Ecuador
1430	LDC — Least Developed Countries	- VU (816)	Vanuatu
1820	OECD (excluding EU)	+ CO (480)	Colombia
2020			
1010	European Union (evolutionary definition)	- GB (006)	United Kingdom ⁴
1011	Extra-European Union (evolutionary definition)	+ GB (006)	United Kingdom ⁴
1115	EEA — European Economic Area	- GB (006)	United Kingdom ⁴
1820	OECD (excluding EU)	+ GB (006)	United Kingdom ⁴
2027	European Union (27_2020)	2028 European Union (28)	
		- GB (006)	United Kingdom
2127	Extra-European Union (27_2020)	2128 Extra-European Union (28)	
		+ GB (006)	United Kingdom
2019			
1053	OPEC — Organisation of Petroleum Exporting Countries	+ CG (318)	Congo
		- QA (644)	Qatar
1815	CIS — Commonwealth of Independent States	- UA (072)	Ukraine
2018			
1053	OPEC — Organisation of Petroleum Exporting Countries	+ GQ (310)	Equatorial Guinea
1330	MERCOSUR — South American Common Market	- VE (484)	Venezuela
1430	LDC — Least Developed Countries	- GQ (310)	Equatorial Guinea
2017			
1053	OPEC — Organisation of Petroleum Exporting Countries	+ GA (314)	Gabon
		- ID (700)	Indonesia

⁴ From 01/02/2020

Economic zones		Changes		
2016				
1053	OPEC — Organisation of Petroleum Exporting Countries	+ ID	(700)	Indonesia
1130	Candidate countries	- IS	(024)	Iceland
2015				
1013	Euro area since 1999 (evolutionary definition)	+ LT	(055)	Lithuania
1014	Extra-euro area since 1999 (evolutionary definition)	- LT	(055)	Lithuania
1130	Candidate countries	+ AL	(070)	Albania
2014				
1013	Euro area since 1999 (evolutionary definition)	+ LV	(054)	Latvia
1014	Extra-euro area since 1999 (evolutionary definition)	- LV	(054)	Latvia
1430	LDC — Least Developed Countries	- WS	(819)	Samoa
2013				
1010	European Union (evolutionary definition)	+ HR	(092)	Croatia ⁵
1011	Extra-European Union (evolutionary definition)	- HR	(092)	Croatia ⁵
		- AN	(478)	Netherlands Antilles
		+ BL	(466)	Saint Barthélemy
		+ BQ	(477)	Bonaire, Sint Eustatius and Saba
		+ CW	(475)	Curaçao
		+ EH	(229)	Western Sahara
		+ SS	(225)	South Sudan
		+ SX	(479)	Sint Maarten (Dutch part)
		+ QP	(955)	High seas
1014	Extra-euro area since 1999 (evolutionary definition)	- AN	(478)	Netherlands Antilles
		+ BL	(466)	Saint Barthélemy
		+ BQ	(477)	Bonaire, Sint Eustatius and Saba
		+ CW	(475)	Curaçao
		+ EH	(229)	Western Sahara
		+ SS	(225)	South Sudan
		+ SX	(479)	Sint Maarten (Dutch part)
		+ QP	(955)	High seas
1051	Mediterranean basin countries (excluding EU)	- HR	(092)	Croatia ⁵
1055	UfM — Union for the Mediterranean (excluding EU)	- HR	(092)	Croatia ⁵
1090	Miscellaneous — Countries not specified and countries not determined	+ QP	(955)	High seas
1115	EEA — European Economic Area	+ HR	(092)	Croatia ⁵
1120	WBCs — Western Balkan Countries (excluding EU)	- HR	(092)	Croatia ⁵

⁵ From 01/07/2013

Economic zones		Changes		
1130	Candidate countries	+ XS	(098)	Serbia
		- HR	(092)	Croatia ⁵
1330	MERCOSUR — South American Common Market	+ VE	(484)	Venezuela
1430	LDC — Least Developed Countries	+ SS	(225)	South Sudan
2012				
1430	LDC — Least Developed Countries	- MV	(667)	Maldives
2011				
1013	Euro area since 1999 (evolutionary definition)	+ EE	(053)	Estonia
1014	Extra-euro area since 1999 (evolutionary definition)	- EE	(053)	Estonia
1130	Candidate countries	+ IS	(024)	Iceland
		+ ME	(097)	Montenegro
1820	OECD (excluding EU)	+ CL	(512)	Chile
		+ IL	(624)	Israel
2010				
1055	UfM — Union for the Mediterranean (excluding EU)	+ AL	(070)	Albania
		+ BA	(093)	Bosnia and Herzegovina
		+ HR	(092)	Croatia
		+ ME	(097)	Montenegro
		+ MR	(228)	Mauritania
1815	CIS — Commonwealth of Independent States	- GE	(076)	Georgia
2009				
1013	Euro area since 1999 (evolutionary definition)	+ SK	(063)	Slovakia
1014	Extra-euro area since 1999 (evolutionary definition)	- SK	(063)	Slovakia
1053	OPEC — Organisation of Petroleum Exporting Countries	- ID	(700)	Indonesia
2008				
1013	Euro area since 1999 (evolutionary definition)	+ CY	(600)	Cyprus
		+ MT	(046)	Malta
1014	Extra-euro area since 1999 (evolutionary definition)	- CY	(600)	Cyprus
		- MT	(046)	Malta
1053	OPEC — Organisation of Petroleum Exporting Countries	+ EC	(500)	Ecuador
1430	LDC — Least Developed Countries	- CV	(247)	Cabo Verde
2007				
1010	European Union (evolutionary definition)	+ BG	(068)	Bulgaria
		+ RO	(066)	Romania
1011	Extra-European Union (evolutionary definition)	- BG	(068)	Bulgaria
		- RO	(066)	Romania
		- XM	(097)	Montenegro
		+ ME	(097)	Montenegro
1013	Euro area since 1999 (evolutionary definition)	+ SI	(091)	Slovenia
1014	Extra-euro area since 1999 (evolutionary definition)	- SI	(091)	Slovenia
		- XM	(097)	Montenegro
		+ ME	(097)	Montenegro

Economic zones		Changes
1031	ACP — African, Caribbean and Pacific countries	Modified title: <i>'ACP — African, Caribbean and Pacific countries, signatories to the Partnership Agreement'</i> replaced by <i>'ACP — African, Caribbean and Pacific countries'</i>
1051	Mediterranean basin countries (excluding EU)	- XM (097) Montenegro + ME (097) Montenegro
1053	OPEC — Organisation of Petroleum Exporting Countries	+ AO (330) Angola
1115	EEA — European Economic Area	+ BG (068) Bulgaria + RO (066) Romania
1120	WBCs — Western Balkan Countries	Modified title: <i>'CEEC — Central and Eastern European countries'</i> replaced by <i>'WBCs — Western Balkan Countries'</i> - BG (068) Bulgaria - RO (066) Romania - XM (097) Montenegro + ME (097) Montenegro
1130	Candidate countries	- BG (068) Bulgaria - RO (066) Romania

- = Deletion / + = Addition

5.2. Latest compositions

5.2.1. EUROPEAN UNION

1010 European Union (evolutionary definition)					
AT	(038)	Austria	From	01/01/1995	
BE	(017)	Belgium	From	01/01/1958	
BG	(068)	Bulgaria	From	01/01/2007	
CY	(600)	Cyprus	From	01/05/2004	
CZ	(061)	Czechia	From	01/05/2004	
DE	(004)	Germany	From	01/01/1958	
DK	(008)	Denmark	From	01/01/1973	
EE	(053)	Estonia	From	01/05/2004	
ES	(011)	Spain	From	01/01/1986	
FI	(032)	Finland	From	01/01/1995	
FR	(001)	France	From	01/01/1958	
GR	(009)	Greece	From	01/01/1981	
HR	(092)	Croatia	From	01/07/2013	
HU	(064)	Hungary	From	01/05/2004	
IE	(007)	Ireland	From	01/01/1973	
IT	(005)	Italy	From	01/01/1958	
LT	(055)	Lithuania	From	01/05/2004	
LU	(018)	Luxembourg	From	01/01/1958	
LV	(054)	Latvia	From	01/05/2004	
MT	(046)	Malta	From	01/05/2004	
NL	(003)	Netherlands	From	01/01/1958	
PL	(060)	Poland	From	01/05/2004	
PT	(010)	Portugal	From	01/01/1986	
RO	(066)	Romania	From	01/01/2007	
SE	(030)	Sweden	From	01/01/1995	
SI	(091)	Slovenia	From	01/05/2004	
SK	(063)	Slovakia	From	01/05/2004	
GB	(006)	United Kingdom	From	01/01/1973	To 31/01/2020
5910		Miscellaneous - countries not specified intra			
1011 Extra-European Union (evolutionary definition)					
5190		European countries excluding EU	5400	Asia	
5200		Africa	5500	Oceania and Polar regions	
5300		America	5920	Miscellaneous - countries not specified extra	

2027 European Union (27_2020)			
AT	(038)	Austria	IE (007) Ireland
BE	(017)	Belgium	IT (005) Italy
BG	(068)	Bulgaria	LT (055) Lithuania
CY	(600)	Cyprus	LU (018) Luxembourg
CZ	(061)	Czechia	LV (054) Latvia
DE	(004)	Germany	MT (046) Malta
DK	(008)	Denmark	NL (003) Netherlands
EE	(053)	Estonia	PL (060) Poland
ES	(011)	Spain	PT (010) Portugal
FI	(032)	Finland	RO (066) Romania
FR	(001)	France	SE (030) Sweden
GR	(009)	Greece	SI (091) Slovenia
HR	(092)	Croatia	SK (063) Slovakia
HU	(064)	Hungary	5910 Miscellaneous - countries not specified intra
2028 European Union (28)			
GB	(006)	United Kingdom	2027 European Union (27_2020)
2127 Extra-European Union (27_2020)			
GB	(006)	United Kingdom	2128 Extra-European Union (28)
2128 Extra-European Union (28)			
AD	(043)	Andorra	RU (075) Russian Federation
AL	(070)	Albania	SM (047) San Marino
BA	(093)	Bosnia and Herzegovina	TR (052) Türkiye
BY	(073)	Belarus	UA (072) Ukraine
CH	(039)	Switzerland	VA (045) Holy See
FO	(041)	Faroe Islands	XK (095) Kosovo
GI	(044)	Gibraltar	XS (098) Serbia
IS	(024)	Iceland	5200 Africa
LI	(037)	Liechtenstein	5300 America
MD	(074)	Moldova, Republic of	5400 Asia
ME	(097)	Montenegro	5500 Oceania and Polar regions
MK	(096)	North Macedonia	5920 Miscellaneous - countries not specified extra
NO	(028)	Norway	

5.2.2. EURO AREA

1013 Euro area since 1999 (evolutionary definition)

AT	(038)	Austria	From	01/01/1999
BE	(017)	Belgium	From	01/01/1999
CY	(600)	Cyprus	From	01/01/2008
DE	(004)	Germany	From	01/01/1999
EE	(053)	Estonia	From	01/01/2011
ES	(011)	Spain	From	01/01/1999
FI	(032)	Finland	From	01/01/1999
FR	(001)	France	From	01/01/1999
GR	(009)	Greece	From	01/01/2001
HR	(092)	Croatia	From	01/01/2023
IE	(007)	Ireland	From	01/01/1999
IT	(005)	Italy	From	01/01/1999
LT	(055)	Lithuania	From	01/01/2015
LU	(018)	Luxembourg	From	01/01/1999
LV	(054)	Latvia	From	01/01/2014
MT	(046)	Malta	From	01/01/2008
NL	(003)	Netherlands	From	01/01/1999
PT	(010)	Portugal	From	01/01/1999
SI	(091)	Slovenia	From	01/01/2007
SK	(063)	Slovakia	From	01/01/2009
5910		Miscellaneous - countries not specified intra		

1014 Extra-euro area since 1999 (evolutionary definition)

BG	(068)	Bulgaria	From	01/01/1999	
CZ	(061)	Czechia	From	01/01/1999	
DK	(008)	Denmark	From	01/01/1999	
HU	(064)	Hungary	From	01/01/1999	
PL	(060)	Poland	From	01/01/1999	
RO	(066)	Romania	From	01/01/1999	
SE	(030)	Sweden	From	01/01/1999	
CY	(600)	Cyprus	From	01/01/1999	To 31/12/2007
EE	(053)	Estonia	From	01/01/1999	To 31/12/2010
HR	(092)	Croatia	From	01/01/1999	To 31/12/2022
LT	(055)	Lithuania	From	01/01/1999	To 31/12/2014
LV	(054)	Latvia	From	01/01/1999	To 31/12/2013
MT	(046)	Malta	From	01/01/1999	To 31/12/2007
SI	(091)	Slovenia	From	01/01/1999	To 31/12/2006
SK	(063)	Slovakia	From	01/01/1999	To 31/12/2008
2127		Extra-European Union (27_2020)			

2019 Euro area (19)					
AT	(038)	Austria	IT	(005)	Italy
BE	(017)	Belgium	LT	(055)	Lithuania
CY	(600)	Cyprus	LU	(018)	Luxembourg
DE	(004)	Germany	LV	(054)	Latvia
EE	(053)	Estonia	MT	(046)	Malta
ES	(011)	Spain	NL	(003)	Netherlands
FI	(032)	Finland	PT	(010)	Portugal
FR	(001)	France	SI	(091)	Slovenia
GR	(009)	Greece	SK	(063)	Slovakia
IE	(007)	Ireland	5910		Miscellaneous - countries not specified intra
2020 Euro area (20)					
HR	(092)	Croatia	2019	Euro area (19)	
2119 Extra-euro area (19)					
HR	(092)	Croatia	2120	Extra-euro area (20)	
2120 Extra-euro area (20)					
BG	(068)	Bulgaria	PL	(060)	Poland
CZ	(061)	Czechia	RO	(066)	Romania
DK	(008)	Denmark	SE	(030)	Sweden
HU	(064)	Hungary	2127	Extra-European Union (27_2020)	

5.2.3. OTHER ECONOMIC ZONES

1000 World					
	1010	European Union (evolutionary definition)		1011	Extra-European Union (evolutionary definition)
1021 EFTA — European Free Trade Association					
	CH (039)	Switzerland		LI (037)	Liechtenstein
	IS (024)	Iceland		NO (028)	Norway
1031 ACP — African, Caribbean and Pacific countries					
	AG (459)	Antigua and Barbuda		LS (395)	Lesotho
	AO (330)	Angola		MG (370)	Madagascar
	BB (469)	Barbados		MH (824)	Marshall Islands
	BF (236)	Burkina Faso		ML (232)	Mali
	BI (328)	Burundi		MR (228)	Mauritania
	BJ (284)	Benin		MU (373)	Mauritius
	BS (453)	Bahamas		MW (386)	Malawi
	BW (391)	Botswana		MZ (366)	Mozambique
	BZ (421)	Belize		NA (389)	Namibia
	CD (322)	Congo, Democratic Republic of		NE (240)	Niger
	CF (306)	Central African Republic		NG (288)	Nigeria
	CG (318)	Congo		NR (803)	Nauru
	CI (272)	Côte d'Ivoire		NU (838)	Niue
	CK (837)	Cook Islands		PG (801)	Papua New Guinea
	CM (302)	Cameroon		PW (825)	Palau
	CU (448)	Cuba		RW (324)	Rwanda
	CV (247)	Cabo Verde		SB (806)	Solomon Islands
	DJ (338)	Djibouti		SC (355)	Seychelles
	DM (460)	Dominica		SD (224)	Sudan
	DO (456)	Dominican Republic		SL (264)	Sierra Leone
	ER (336)	Eritrea		SN (248)	Senegal
	ET (334)	Ethiopia		SO (342)	Somalia
	FJ (815)	Fiji		SR (492)	Suriname
	FM (823)	Micronesia, Federated States of		ST (311)	Sao Tome and Principe
	GA (314)	Gabon		SZ (393)	Eswatini
	GD (473)	Grenada		TD (244)	Chad
	GH (276)	Ghana		TG (280)	Togo
	GM (252)	Gambia		TL (626)	Timor-Leste
	GN (260)	Guinea		TO (817)	Tonga
	GQ (310)	Equatorial Guinea		TT (472)	Trinidad and Tobago
	GW (257)	Guinea-Bissau		TV (807)	Tuvalu
	GY (488)	Guyana		TZ (352)	Tanzania, United Republic of
	HT (452)	Haiti		UG (350)	Uganda
	JM (464)	Jamaica		VC (467)	St Vincent and the Grenadines
	KE (346)	Kenya		VU (816)	Vanuatu
	KI (812)	Kiribati		WS (819)	Samoa
	KM (375)	Comoros		ZA (388)	South Africa
	KN (449)	St Kitts and Nevis		ZM (378)	Zambia
	LC (465)	Saint Lucia		ZW (382)	Zimbabwe
	LR (268)	Liberia			

1051 Mediterranean basin countries (excluding EU)					
AL	(070)	Albania	ME	(097)	Montenegro
BA	(093)	Bosnia and Herzegovina	MK	(096)	North Macedonia
DZ	(208)	Algeria	PS	(625)	Palestinian Territory, Occupied
EG	(220)	Egypt	SY	(608)	Syrian Arab Republic
GI	(044)	Gibraltar	TN	(212)	Tunisia
IL	(624)	Israel	TR	(052)	Türkiye
JO	(628)	Jordan	XC	(021)	Ceuta
LB	(604)	Lebanon	XK	(095)	Kosovo
LY	(216)	Libya	XL	(023)	Melilla
MA	(204)	Morocco	XS	(098)	Serbia
1053 OPEC — Organisation of Petroleum Exporting Countries					
AE	(647)	United Arab Emirates	IR	(616)	Iran, Islamic Republic of
CG	(318)	Congo	KW	(636)	Kuwait
DZ	(208)	Algeria	LY	(216)	Libya
GA	(314)	Gabon	NG	(288)	Nigeria
GQ	(310)	Equatorial Guinea	SA	(632)	Saudi Arabia
IQ	(612)	Iraq	VE	(484)	Venezuela, Bolivarian Republic of
1055 UfM — Union for the Mediterranean (excluding EU)					
AL	(070)	Albania	ME	(097)	Montenegro
BA	(093)	Bosnia and Herzegovina	MK	(096)	North Macedonia
DZ	(208)	Algeria	MR	(228)	Mauritania
EG	(220)	Egypt	PS	(625)	Palestinian Territory, Occupied
IL	(624)	Israel	SY	(608)	Syrian Arab Republic
JO	(628)	Jordan	TN	(212)	Tunisia
LB	(604)	Lebanon	TR	(052)	Türkiye
MA	(204)	Morocco			
1057 ASEAN — Association of South-East Asian Nations					
BN	(703)	Brunei Darussalam	MY	(701)	Malaysia
ID	(700)	Indonesia	PH	(708)	Philippines
KH	(696)	Cambodia	SG	(706)	Singapore
LA	(684)	Lao People's Democratic Republic	TH	(680)	Thailand
MM	(676)	Myanmar	VN	(690)	Viet Nam
1058 Latin American countries					
AR	(528)	Argentina	HN	(424)	Honduras
BO	(516)	Bolivia, Plurinational State of	HT	(452)	Haiti
BR	(508)	Brazil	MX	(412)	Mexico
CL	(512)	Chile	NI	(432)	Nicaragua
CO	(480)	Colombia	PA	(442)	Panama
CR	(436)	Costa Rica	PE	(504)	Peru
CU	(448)	Cuba	PY	(520)	Paraguay
DO	(456)	Dominican Republic	SV	(428)	El Salvador
EC	(500)	Ecuador	UY	(524)	Uruguay
GT	(416)	Guatemala	VE	(484)	Venezuela, Bolivarian Republic of

1059 SAARC — South Asian Association for Regional Cooperation					
AF	(660)	Afghanistan	LK	(669)	Sri Lanka
BD	(666)	Bangladesh	MV	(667)	Maldives
BT	(675)	Bhutan	NP	(672)	Nepal
IN	(664)	India	PK	(662)	Pakistan
1090 Miscellaneous — Countries not specified and countries not determined					
	1091	Miscellaneous - countries not specified intra		1092	Miscellaneous - countries not specified extra
1091 Miscellaneous — Countries not specified intra					
QR	(951)	Stores and provisions within the framework of intra-Union trade	QY	(978)	Countries and territories not specified for commercial or military reasons in the framework of intra-Union trade
QV	(959)	Countries and territories not specified in the framework of intra-Union trade			
1092 Miscellaneous — Countries not specified extra					
QP	(955)	High seas	QW	(960)	Countries and territories not specified within the framework of extra-Union trade
QQ	(950)	Stores and provisions	QX	(977)	Countries and territories not specified for commercial or military reasons
QS	(952)	Stores and provisions within the framework of extra-Union trade	QZ	(979)	Countries and territories not specified for commercial or military reasons in the framework of extra-Union trade
QU	(958)	Countries and territories not specified			
1115 EEA — European Economic Area					
IS	(024)	Iceland	NO	(028)	Norway
LI	(037)	Liechtenstein		1010	European Union (evolutionary definition)
1120 WBCs — Western Balkan Countries					
AL	(070)	Albania	MK	(096)	North Macedonia
BA	(093)	Bosnia and Herzegovina	XK	(095)	Kosovo
ME	(097)	Montenegro	XS	(098)	Serbia
1130 Candidate countries					
AL	(070)	Albania	MK	(096)	North Macedonia
BA	(093)	Bosnia and Herzegovina	TR	(052)	Türkiye
GE	(076)	Georgia	UA	(072)	Ukraine
MD	(074)	Moldova, Republic of	XS	(098)	Serbia
ME	(097)	Montenegro			

1310 USMCA — United States-Mexico-Canada Agreement⁶					
CA	(404)	Canada	US	(400)	United States
MX	(412)	Mexico			
1330 MERCOSUR — South American Common Market					
AR	(528)	Argentina	PY	(520)	Paraguay
BO	(516)	Bolivia, Plurinational State of	UY	(524)	Uruguay
BR	(508)	Brazil			
1410 NICs — Newly-industrialised Asian countries					
HK	(740)	Hong Kong	SG	(706)	Singapore
KR	(728)	Korea, Republic of	TW	(736)	Taiwan
1415 DAEs — Dynamic Asian economies					
HK	(740)	Hong Kong	SG	(706)	Singapore
KR	(728)	Korea, Republic of	TH	(680)	Thailand
MY	(701)	Malaysia	TW	(736)	Taiwan
1420 APEC — Asia Pacific Economic Cooperation					
AU	(800)	Australia	NZ	(804)	New Zealand
BN	(703)	Brunei Darussalam	PE	(504)	Peru
CA	(404)	Canada	PG	(801)	Papua New Guinea
CL	(512)	Chile	PH	(708)	Philippines
CN	(720)	China	RU	(075)	Russian Federation
HK	(740)	Hong Kong	SG	(706)	Singapore
ID	(700)	Indonesia	TH	(680)	Thailand
JP	(732)	Japan	TW	(736)	Taiwan
KR	(728)	Korea, Republic of	US	(400)	United States
MX	(412)	Mexico	VN	(690)	Viet Nam
MY	(701)	Malaysia			

⁶ The United States-Mexico-Canada Agreement (USMCA), which came into force on 1 July 2020, replaced the North American Free Trade Agreement (NAFTA) first implemented in 1994.

1430 LDC — Least Developed Countries					
AF	(660)	Afghanistan	MM	(676)	Myanmar
AO	(330)	Angola	MR	(228)	Mauritania
BD	(666)	Bangladesh	MW	(386)	Malawi
BF	(236)	Burkina Faso	MZ	(366)	Mozambique
BI	(328)	Burundi	NE	(240)	Niger
BJ	(284)	Benin	NP	(672)	Nepal
CD	(322)	Congo, Democratic Republic of	RW	(324)	Rwanda
CF	(306)	Central African Republic	SB	(806)	Solomon Islands
DJ	(338)	Djibouti	SD	(224)	Sudan
ER	(336)	Eritrea	SL	(264)	Sierra Leone
ET	(334)	Ethiopia	SN	(248)	Senegal
GM	(252)	Gambia	SO	(342)	Somalia
GN	(260)	Guinea	SS	(225)	South Sudan
GW	(257)	Guinea-Bissau	ST	(311)	Sao Tome and Principe
HT	(452)	Haiti	TD	(244)	Chad
KH	(696)	Cambodia	TG	(280)	Togo
KI	(812)	Kiribati	TL	(626)	Timor-Leste
KM	(375)	Comoros	TV	(807)	Tuvalu
LA	(684)	Lao People's Democratic Republic	TZ	(352)	Tanzania, United Republic of
LR	(268)	Liberia	UG	(350)	Uganda
LS	(395)	Lesotho	YE	(653)	Yemen
MG	(370)	Madagascar	ZM	(378)	Zambia
ML	(232)	Mali			
1815 CIS — Commonwealth of Independent States					
AM	(077)	Armenia	MD	(074)	Moldova, Republic of
AZ	(078)	Azerbaijan	RU	(075)	Russian Federation
BY	(073)	Belarus	TJ	(082)	Tajikistan
KG	(083)	Kyrgyzstan	TM	(080)	Turkmenistan
KZ	(079)	Kazakhstan	UZ	(081)	Uzbekistan
1820 OECD (excluding EU) — Organisation for Economic Cooperation and Development (excluding EU)					
AU	(800)	Australia	JP	(732)	Japan
CA	(404)	Canada	KR	(728)	Korea, Republic of
CH	(039)	Switzerland	MX	(412)	Mexico
CL	(512)	Chile	NO	(028)	Norway
CO	(480)	Colombia	NZ	(804)	New Zealand
CR	(436)	Costa Rica	TR	(052)	Türkiye
GB	(006)	United Kingdom	US	(400)	United States
IL	(624)	Israel	VI	(457)	Virgin Islands (US)
IS	(024)	Iceland			

6

Geographical zones

6.1. Changes since 2007

Geographical zones		Changes		
2020				
5110	European Union	- GB	(006)	United Kingdom ⁷
5190	European countries excluding EU	+ GB	(006)	United Kingdom ⁷
2013				
5110	European Union	+ HR	(092)	Croatia ⁸
5190	European countries excluding EU	- HR	(092)	Croatia ⁸
5200	Africa	+ EH	(229)	Western Sahara
		+ SS	(225)	South Sudan
5210	North Africa	+ EH	(229)	Western Sahara
5290	Other African countries	+ SS	(225)	South Sudan
5300	America	- AN	(478)	Netherlands Antilles
		+ BL	(466)	Saint Barthélemy
		+ BQ	(477)	Bonaire, Sint Eustatius and Saba
		+ CW	(475)	Curaçao
		+ SX	(479)	Sint Maarten (Dutch part)
5320	Central America and Caribbean	- AN	(478)	Netherlands Antilles
		+ BL	(466)	Saint Barthélemy
		+ BQ	(477)	Bonaire, Sint Eustatius and Saba
		+ CW	(475)	Curaçao
		+ SX	(479)	Sint Maarten (Dutch part)
5900	Miscellaneous — Countries not specified and countries not determined	+ QP	(955)	High seas
5920	Miscellaneous — Countries not specified extra	+ QP	(955)	High seas

⁷ From 01/02/2020

⁸ From 01/07/2013

2007		
Geographical zones	Changes	
5000 World	- 5900	Miscellaneous — Countries not specified and countries not determined
	+ 5920	Miscellaneous — Countries not specified extra
5110 European Union	+ BG	(068) Bulgaria
	+ RO	(066) Romania
5190 European countries excluding EU	- BG	(068) Bulgaria
	- RO	(066) Romania
	- XM	(097) Montenegro
	+ ME	(097) Montenegro

- = Deletion / + = Addition

6.2. Latest compositions

5000 World			
5100	Europe		
5200	Africa		
5300	America		
5400	Asia		
5500	Oceania and Polar regions		
5920	Miscellaneous - countries not specified extra		
5100 Europe			
5110	European Union		
5190	European countries excluding EU		
5110 European Union			
AT	(038)	Austria	
BE	(017)	Belgium	
BG	(068)	Bulgaria	
CY	(600)	Cyprus	
CZ	(061)	Czechia	
DE	(004)	Germany	
DK	(008)	Denmark	
EE	(053)	Estonia	
ES	(011)	Spain	
FI	(032)	Finland	
FR	(001)	France	
GR	(009)	Greece	
HR	(092)	Croatia	
HU	(064)	Hungary	
IE	(007)	Ireland	
IT	(005)	Italy	
LT	(055)	Lithuania	
LU	(018)	Luxembourg	
LV	(054)	Latvia	
MT	(046)	Malta	
NL	(003)	Netherlands	
PL	(060)	Poland	
PT	(010)	Portugal	
RO	(066)	Romania	
SE	(030)	Sweden	
SI	(091)	Slovenia	
SK	(063)	Slovakia	
5910	Miscellaneous - countries not specified intra		
5190 European countries excluding EU			
AD	(043)	Andorra	
AL	(070)	Albania	
BA	(093)	Bosnia and Herzegovina	
BY	(073)	Belarus	
CH	(039)	Switzerland	
FO	(041)	Faroe Islands	
GB	(006)	United Kingdom	
GI	(044)	Gibraltar	
IS	(024)	Iceland	
LI	(037)	Liechtenstein	
MD	(074)	Moldova, Republic of	
ME	(097)	Montenegro	
MK	(096)	North Macedonia	
NO	(028)	Norway	
RU	(075)	Russian Federation	
SM	(047)	San Marino	
TR	(052)	Türkiye	
UA	(072)	Ukraine	
VA	(045)	Holy See	
XK	(095)	Kosovo	
XS	(098)	Serbia	
5200 Africa			
5210	North Africa		
5290	Other African countries		
5210 North Africa			
DZ	(208)	Algeria	
EG	(220)	Egypt	
EH	(229)	Western Sahara	
LY	(216)	Libya	
MA	(204)	Morocco	
TN	(212)	Tunisia	
XC	(021)	Ceuta	
XL	(023)	Melilla	

5290 Other African countries			
AO	(330)	Angola	ML (232) Mali
BF	(236)	Burkina Faso	MR (228) Mauritania
BI	(328)	Burundi	MU (373) Mauritius
BJ	(284)	Benin	MW (386) Malawi
BW	(391)	Botswana	MZ (366) Mozambique
CD	(322)	Congo, Democratic Republic of	NA (389) Namibia
CF	(306)	Central African Republic	NE (240) Niger
CG	(318)	Congo	NG (288) Nigeria
CI	(272)	Côte d'Ivoire	RW (324) Rwanda
CM	(302)	Cameroon	SC (355) Seychelles
CV	(247)	Cabo Verde	SD (224) Sudan
DJ	(338)	Djibouti	SH (329) Saint Helena, Ascension and Tristan da Cunha
ER	(336)	Eritrea	SL (264) Sierra Leone
ET	(334)	Ethiopia	SN (248) Senegal
GA	(314)	Gabon	SO (342) Somalia
GH	(276)	Ghana	SS (225) South Sudan
GM	(252)	Gambia	ST (311) Sao Tome and Principe
GN	(260)	Guinea	SZ (393) Eswatini
GQ	(310)	Equatorial Guinea	TD (244) Chad
GW	(257)	Guinea-Bissau	TG (280) Togo
IO	(357)	British Indian Ocean Territory	TZ (352) Tanzania, United Republic of
KE	(346)	Kenya	UG (350) Uganda
KM	(375)	Comoros	ZA (388) South Africa
LR	(268)	Liberia	ZM (378) Zambia
LS	(395)	Lesotho	ZW (382) Zimbabwe
MG	(370)	Madagascar	
5300 America			
	5310	North America	5330 South America
	5320	Central America and Caribbean	
5310 North America			
CA	(404)	Canada	PM (408) Saint Pierre and Miquelon
GL	(406)	Greenland	US (400) United States
5320 Central America and Caribbean			
AG	(459)	Antigua and Barbuda	HT (452) Haiti
AI	(446)	Anguilla	JM (464) Jamaica
AW	(474)	Aruba	KN (449) St Kitts and Nevis
BB	(469)	Barbados	KY (463) Cayman Islands
BL	(466)	Saint Barthélemy	LC (465) Saint Lucia
BM	(413)	Bermuda	MS (470) Montserrat
BQ	(477)	Bonaire, Sint Eustatius and Saba	MX (412) Mexico
BS	(453)	Bahamas	NI (432) Nicaragua
BZ	(421)	Belize	PA (442) Panama
CR	(436)	Costa Rica	SV (428) El Salvador
CU	(448)	Cuba	SX (479) Sint Maarten (Dutch part)
CW	(475)	Curaçao	TC (454) Turks and Caicos Islands
DM	(460)	Dominica	TT (472) Trinidad and Tobago
DO	(456)	Dominican Republic	VC (467) St Vincent and the Grenadines
GD	(473)	Grenada	VG (468) Virgin Islands, British
GT	(416)	Guatemala	VI (457) Virgin Islands (US)
HN	(424)	Honduras	

5330 South America			
AR	(528)	Argentina	GY (488) Guyana
BO	(516)	Bolivia, Plurinational State of	PE (504) Peru
BR	(508)	Brazil	PY (520) Paraguay
CL	(512)	Chile	SR (492) Suriname
CO	(480)	Colombia	UY (524) Uruguay
EC	(500)	Ecuador	VE (484) Venezuela, Bolivarian Republic of
FK	(529)	Falkland Islands	
5400 Asia			
	5410	Near and Middle Eastern countries	5490 Other Asian countries
5410 Near and Middle Eastern countries			
AE	(647)	United Arab Emirates	KW (636) Kuwait
AM	(077)	Armenia	LB (604) Lebanon
AZ	(078)	Azerbaijan	OM (649) Oman
BH	(640)	Bahrain	PS (625) Palestinian Territory, Occupied
GE	(076)	Georgia	QA (644) Qatar
IL	(624)	Israel	SA (632) Saudi Arabia
IQ	(612)	Iraq	SY (608) Syrian Arab Republic
IR	(616)	Iran, Islamic Republic of	YE (653) Yemen
JO	(628)	Jordan	
5490 Other Asian countries			
AF	(660)	Afghanistan	MM (676) Myanmar
BD	(666)	Bangladesh	MN (716) Mongolia
BN	(703)	Brunei Darussalam	MO (743) Macao
BT	(675)	Bhutan	MV (667) Maldives
CN	(720)	China	MY (701) Malaysia
HK	(740)	Hong Kong	NP (672) Nepal
ID	(700)	Indonesia	PH (708) Philippines
IN	(664)	India	PK (662) Pakistan
JP	(732)	Japan	SG (706) Singapore
KG	(083)	Kyrgyzstan	TH (680) Thailand
KH	(696)	Cambodia	TJ (082) Tajikistan
KP	(724)	Korea, Democratic People's Republic of	TL (626) Timor-Leste
KR	(728)	Korea, Republic of	TM (080) Turkmenistan
KZ	(079)	Kazakhstan	TW (736) Taiwan
LA	(684)	Lao People's Democratic Republic	UZ (081) Uzbekistan
LK	(669)	Sri Lanka	VN (690) Viet Nam
5500 Oceania and Polar regions			
	5510	Australia and New Zealand	5590 Other countries of Oceania and Polar regions
5510 Australia and New Zealand			
AU	(800)	Australia	NF (836) Norfolk Island
CC	(833)	Cocos (Keeling), Islands	NU (838) Niue
CK	(837)	Cook Islands	NZ (804) New Zealand
CX	(834)	Christmas Island	TK (839) Tokelau
HM	(835)	Heard Island and McDonald Islands	

5590 Other countries of Oceania and Polar regions			
AQ	(891)	Antarctica	PF (822) French Polynesia
AS	(830)	American Samoa	PG (801) Papua New Guinea
BV	(892)	Bouvet Island	PN (813) Pitcairn
FJ	(815)	Fiji	PW (825) Palau
FM	(823)	Micronesia, Federated States of	SB (806) Solomon Islands
GS	(893)	South Georgia and South Sandwich Islands	TF (894) French Southern Territories
GU	(831)	Guam	TO (817) Tonga
KI	(812)	Kiribati	TV (807) Tuvalu
MH	(824)	Marshall Islands	UM (832) United States Minor Outlying Islands
MP	(820)	Northern Mariana Islands	VU (816) Vanuatu
NC	(809)	New Caledonia	WF (811) Wallis and Futuna
NR	(803)	Nauru	WS (819) Samoa
5900 Miscellaneous — Countries not specified and countries not determined			
5910		Miscellaneous - countries not specified intra	5920 Miscellaneous - countries not specified extra
5910 Miscellaneous — Countries not specified intra			
QR	(951)	Stores and provisions within the framework of intra-Union trade	QY (978) Countries and territories not specified for commercial or military reasons in the framework of intra-Union trade
QV	(959)	Countries and territories not specified in the framework of intra-Union trade	
5920 Miscellaneous — Countries not specified extra			
QP	(955)	High seas	QW (960) Countries and territories not specified within the framework of extra-Union trade
QQ	(950)	Stores and provisions	QX (977) Countries and territories not specified for commercial or military reasons
QS	(952)	Stores and provisions within the framework of extra-Union trade	QZ (979) Countries and territories not specified for commercial or military reasons in the framework of extra-Union trade
QU	(958)	Countries and territories not specified	

7

Maps

This chapter graphically illustrates the zones which are documented in [Chapter 6 Geographical zones](#), with their respective composition.

Maps are produced by the Geographic information system (GIS) software maintained by the European Commission. They are provided for illustration purposes only, and do not aim at being a geo-referencing tool. Moreover, the Commission accepts no responsibility or liability whatsoever with regard to the information on this geographical dataset. More information on GIS are available at: <https://ec.europa.eu/eurostat/web/gisco/geodata>.

7.1. World

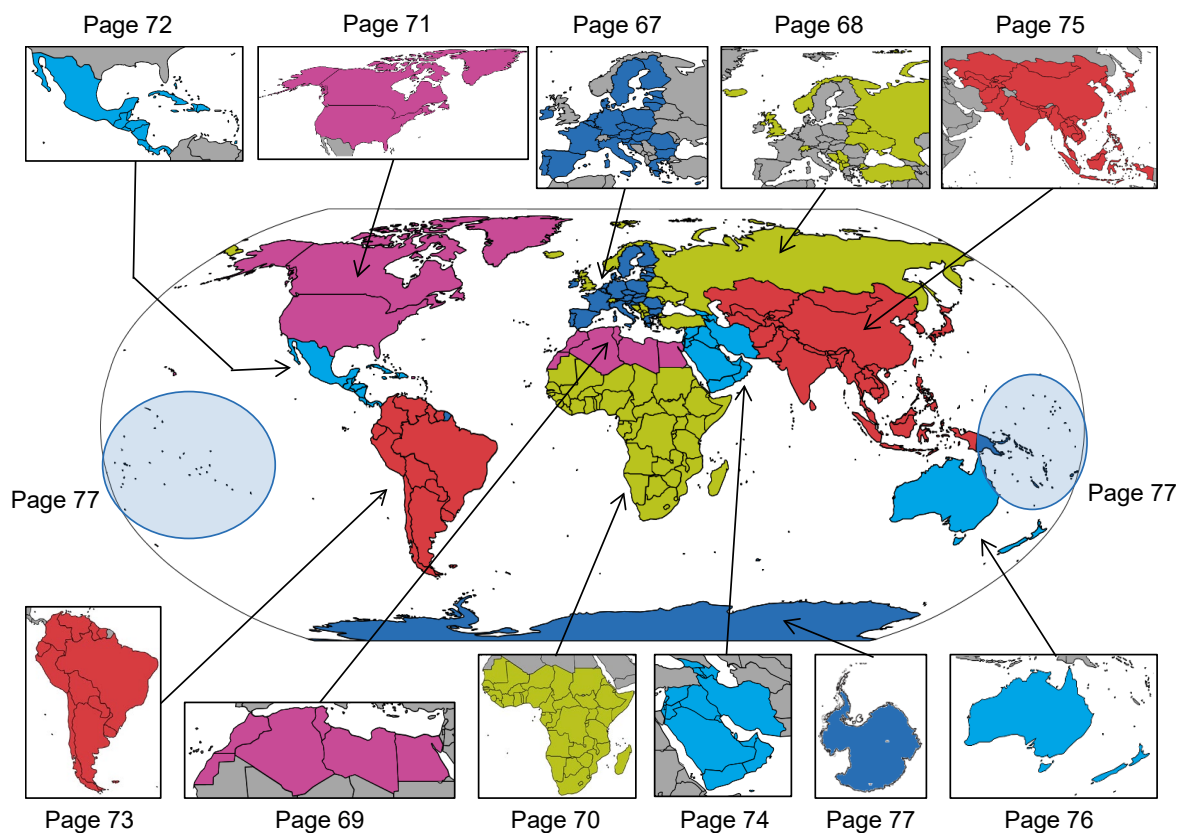

5000 World			
5100	Europe	5400	Asia
5200	Africa	5500	Oceania and Polar regions
5300	America	5920	Miscellaneous - countries not specified extra

7.2. Europe

5100 Europe			
5110	European Union	5190	European countries excluding EU

7.2.1. EUROPEAN UNION

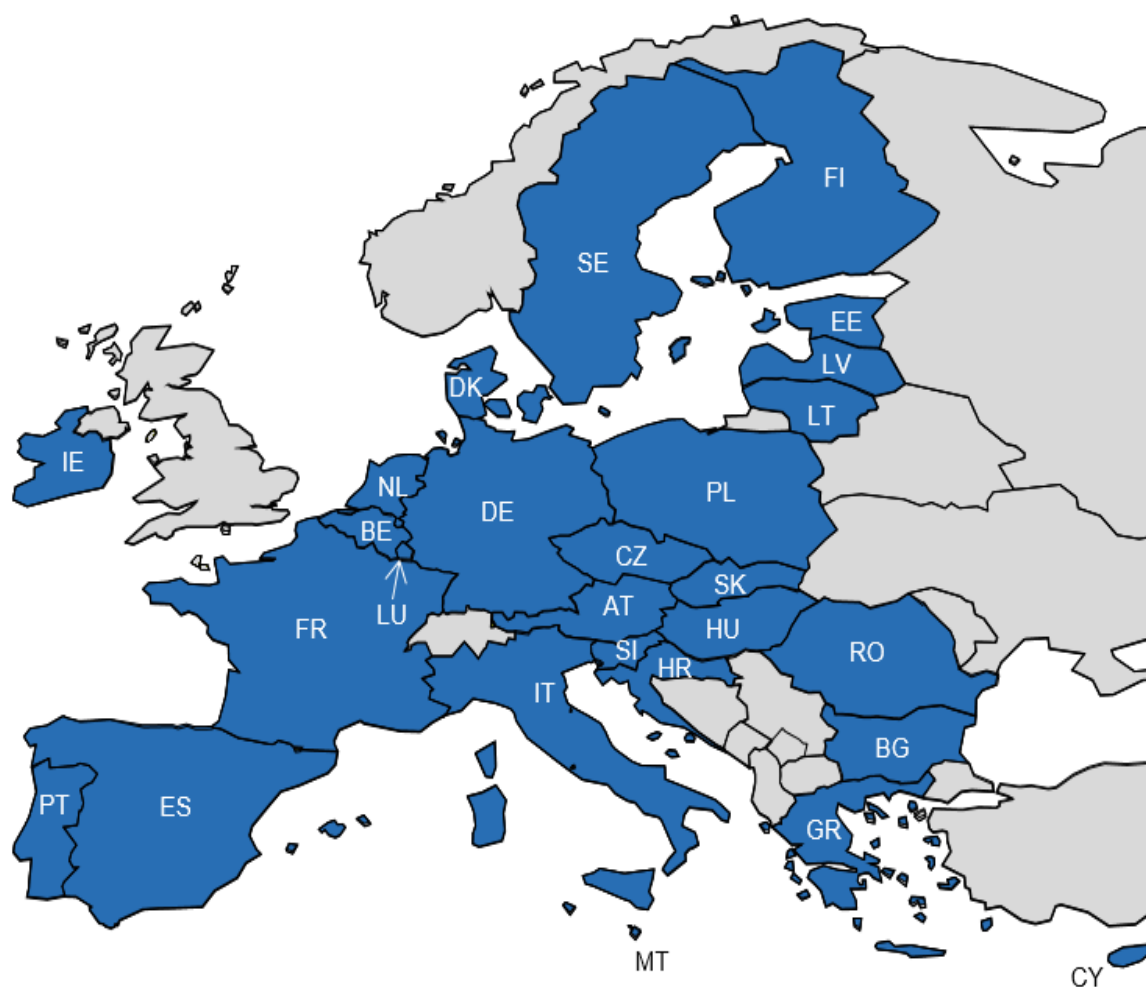

5110 European Union					
AT	(038)	Austria	IE	(007)	Ireland
BE	(017)	Belgium	IT	(005)	Italy
BG	(068)	Bulgaria	LT	(055)	Lithuania
CY	(600)	Cyprus	LU	(018)	Luxembourg
CZ	(061)	Czechia	LV	(054)	Latvia
DE	(004)	Germany	MT	(046)	Malta
DK	(008)	Denmark	NL	(003)	Netherlands
EE	(053)	Estonia	PL	(060)	Poland
ES	(011)	Spain	PT	(010)	Portugal
FI	(032)	Finland	RO	(066)	Romania
FR	(001)	France	SE	(030)	Sweden
GR	(009)	Greece	SI	(091)	Slovenia
HR	(092)	Croatia	SK	(063)	Slovakia
HU	(064)	Hungary	5910		Miscellaneous - countries not specified intra

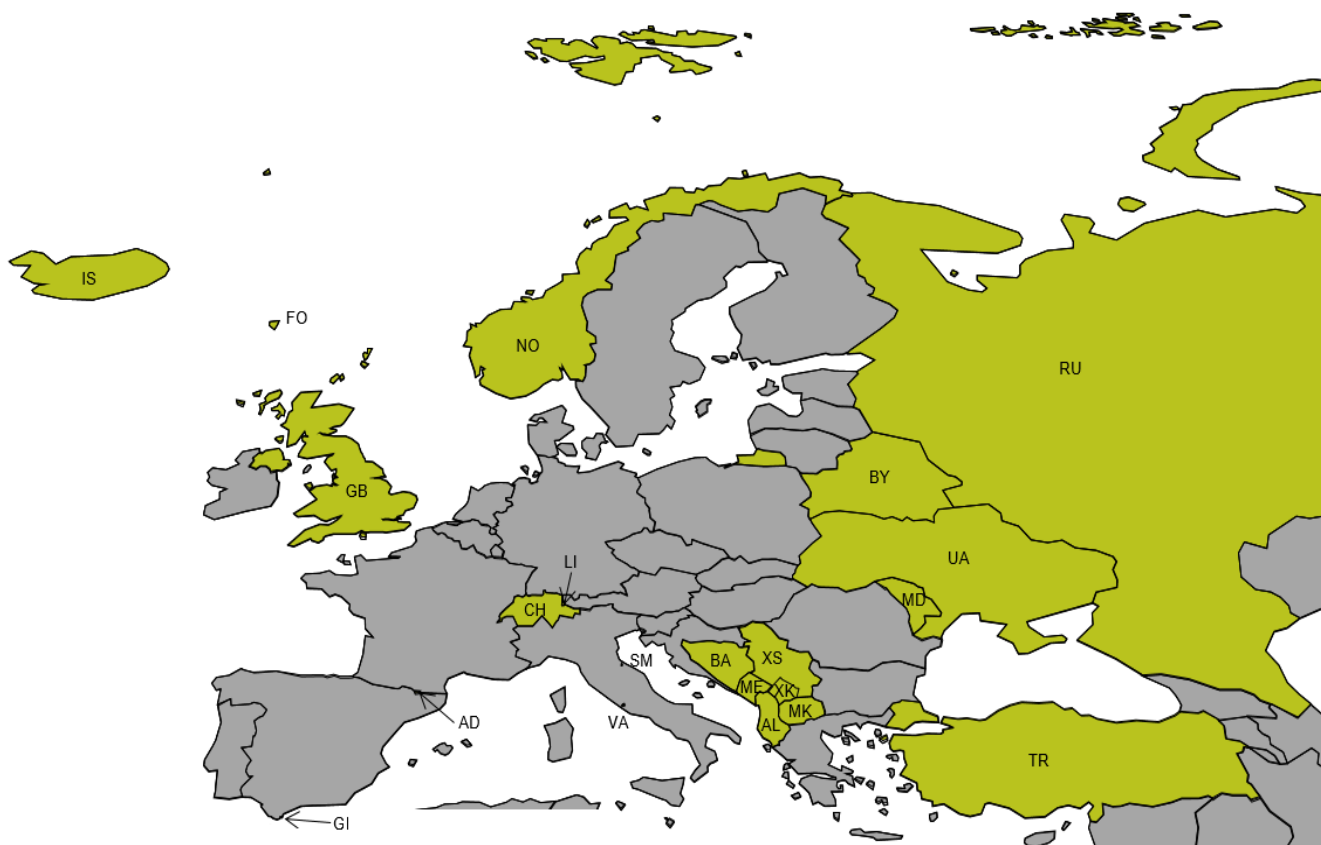
7.2.2. EUROPEAN COUNTRIES EXCLUDING EU

5190 European countries excluding EU

AD	(043)	Andorra	ME	(097)	Montenegro
AL	(070)	Albania	MK	(096)	North Macedonia
BA	(093)	Bosnia and Herzegovina	NO	(028)	Norway
BY	(073)	Belarus	RU	(075)	Russian Federation
CH	(039)	Switzerland	SM	(047)	San Marino
FO	(041)	Faroe Islands	TR	(052)	Türkiye
GB	(006)	United Kingdom	UA	(072)	Ukraine
GI	(044)	Gibraltar	VA	(045)	Holy See
IS	(024)	Iceland	XK	(095)	Kosovo
LI	(037)	Liechtenstein	XS	(098)	Serbia
MD	(074)	Moldova, Republic of			

7.3. Africa

5200	Africa
5210	North Africa
5290	Other African countries

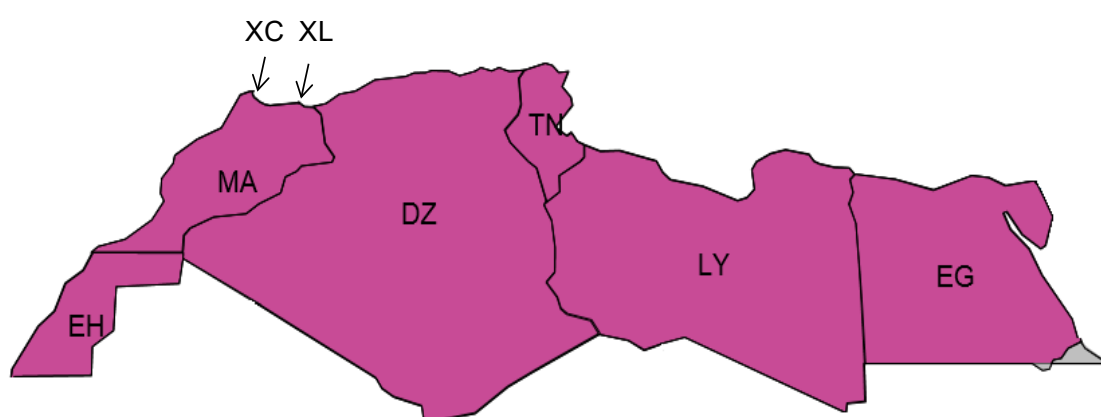
7.3.1. NORTH AFRICA



5210	North Africa			
DZ	(208)	Algeria	MA	(204) Morocco
EG	(220)	Egypt	TN	(212) Tunisia
EH	(229)	Western Sahara	XC	(021) Ceuta
LY	(216)	Libya	XL	(023) Melilla

7.3.2. OTHER AFRICAN COUNTRIES

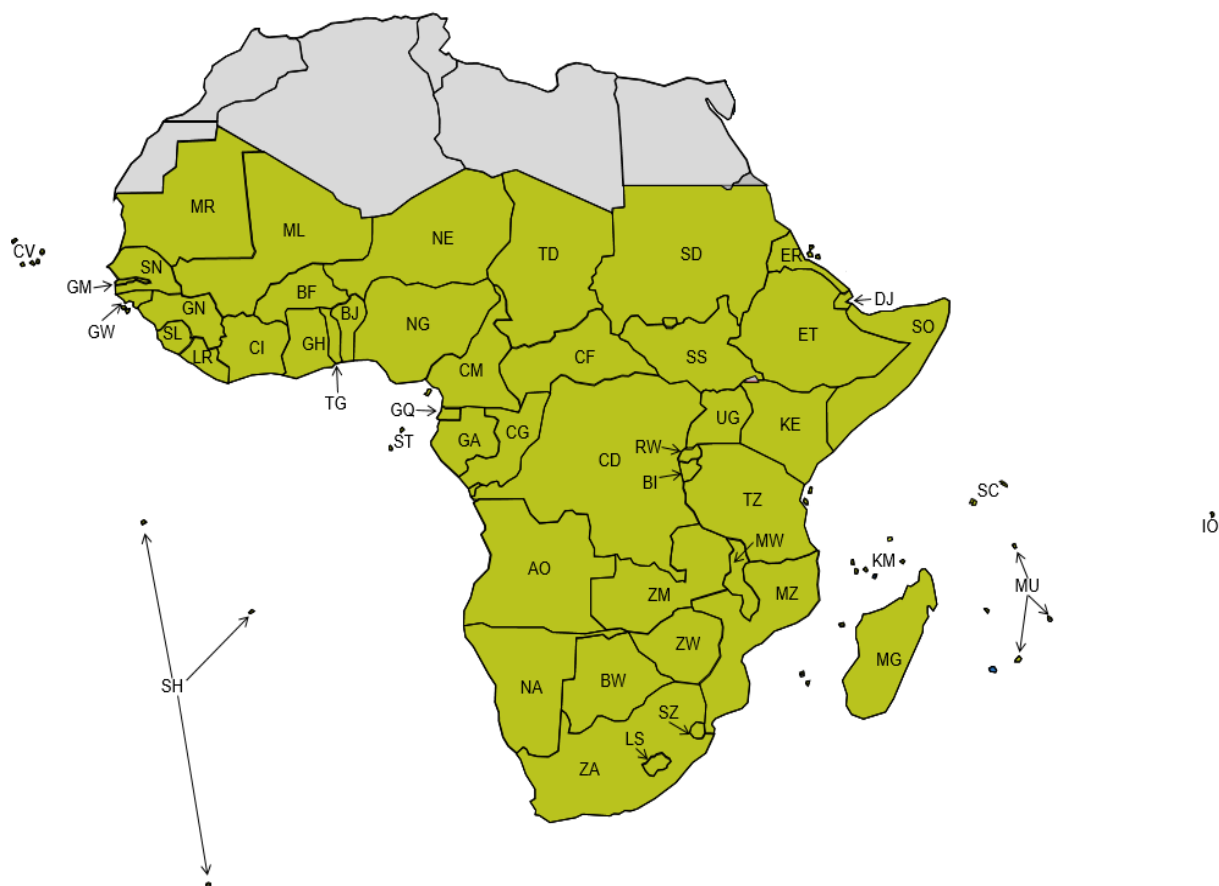

5290 Other African countries		
AO	(330)	Angola
BF	(236)	Burkina Faso
BI	(328)	Burundi
BJ	(284)	Benin
BW	(391)	Botswana
CD	(322)	Congo, Democratic Republic of
CF	(306)	Central African Republic
CG	(318)	Congo
CI	(272)	Côte d'Ivoire
CM	(302)	Cameroon
CV	(247)	Cabo Verde
DJ	(338)	Djibouti
ER	(336)	Eritrea
ET	(334)	Ethiopia
GA	(314)	Gabon
GH	(276)	Ghana
GM	(252)	Gambia
GN	(260)	Guinea
GQ	(310)	Equatorial Guinea
GW	(257)	Guinea-Bissau
IO	(357)	British Indian Ocean Territory
KE	(346)	Kenya
KM	(375)	Comoros
LR	(268)	Liberia
LS	(395)	Lesotho
MG	(370)	Madagascar
ML	(232)	Mali
MR	(228)	Mauritania
MU	(373)	Mauritius
MW	(386)	Malawi
MZ	(366)	Mozambique
NA	(389)	Namibia
NE	(240)	Niger
NG	(288)	Nigeria
RW	(324)	Rwanda
SC	(355)	Seychelles
SD	(224)	Sudan
SH	(329)	Saint Helena, Ascension and Tristan da Cunha
SL	(264)	Sierra Leone
SN	(248)	Senegal
SO	(342)	Somalia
SS	(225)	South Sudan
ST	(311)	Sao Tome and Principe
SZ	(393)	Eswatini
TD	(244)	Chad
TG	(280)	Togo
TZ	(352)	Tanzania, United Republic of
UG	(350)	Uganda
ZA	(388)	South Africa
ZM	(378)	Zambia
ZW	(382)	Zimbabwe

7.4. America

5300 America				
	5310	North America	5330	South America
	5320	Central America and Caribbean		

7.4.1. NORTH AMERICA

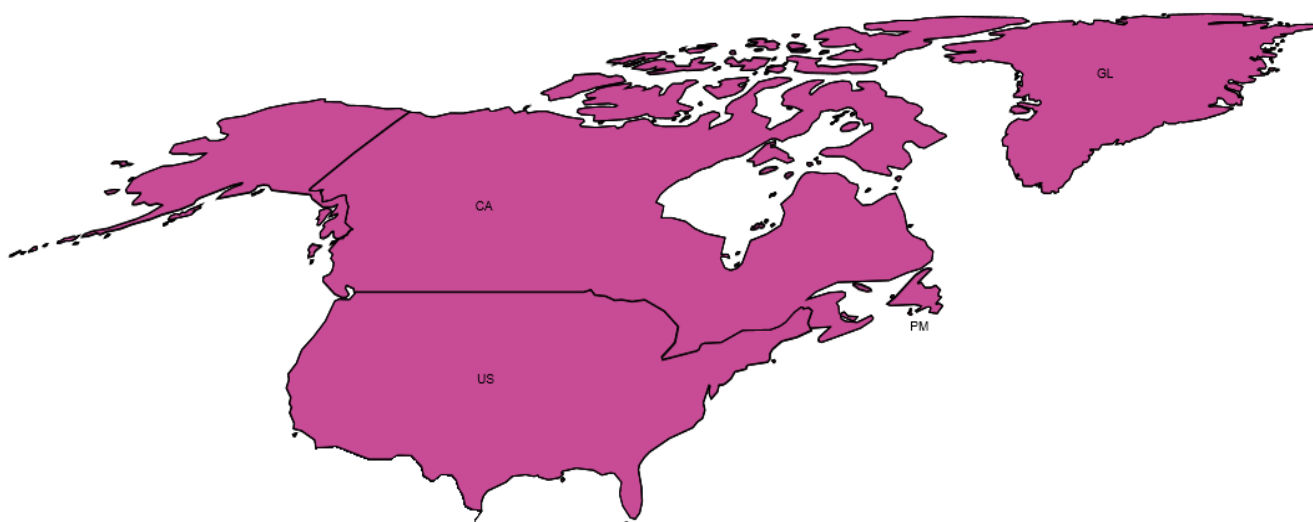

5310 North America				
	CA	(404) Canada	PM	(408) Saint Pierre and Miquelon
	GL	(406) Greenland	US	(400) United States

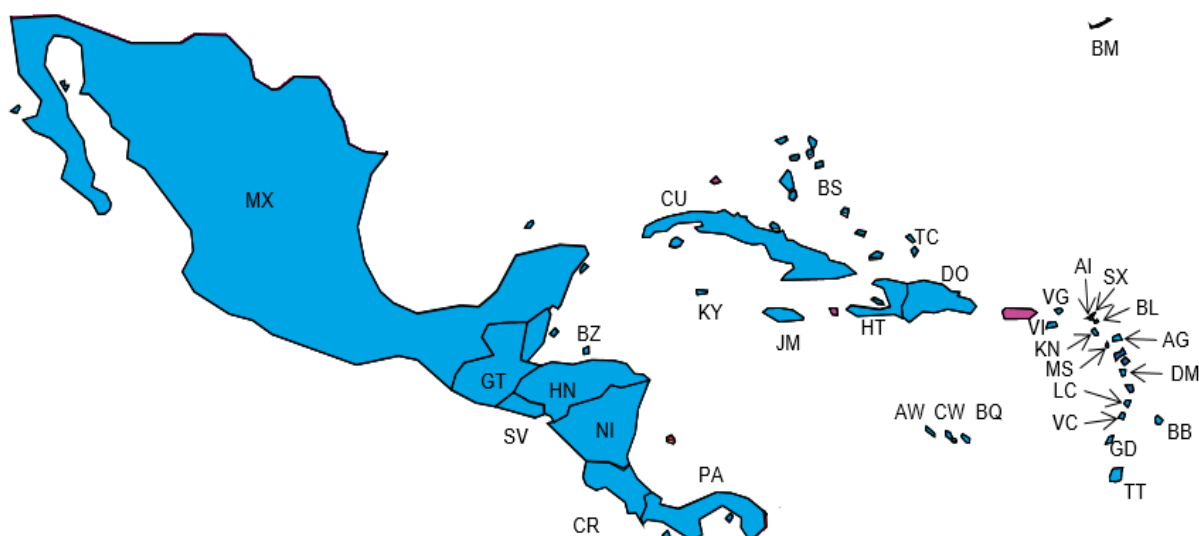
7.4.2. CENTRAL AMERICA AND CARIBBEAN

5320		Central America and Caribbean			
AG	(459)	Antigua and Barbuda	HT	(452)	Haiti
AI	(446)	Anguilla	JM	(464)	Jamaica
AW	(474)	Aruba	KN	(449)	St Kitts and Nevis
BB	(469)	Barbados	KY	(463)	Cayman Islands
BL	(466)	Saint Barthélemy	LC	(465)	Saint Lucia
BM	(413)	Bermuda	MS	(470)	Montserrat
BQ	(477)	Bonaire, Sint Eustatius and Saba	MX	(412)	Mexico
BS	(453)	Bahamas	NI	(432)	Nicaragua
BZ	(421)	Belize	PA	(442)	Panama
CR	(436)	Costa Rica	SV	(428)	El Salvador
CU	(448)	Cuba	SX	(479)	Sint Maarten (Dutch part)
CW	(475)	Curaçao	TC	(454)	Turks and Caicos Islands
DM	(460)	Dominica	TT	(472)	Trinidad and Tobago
DO	(456)	Dominican Republic	VC	(467)	St Vincent and the Grenadines
GD	(473)	Grenada	VG	(468)	Virgin Islands, British
GT	(416)	Guatemala	VI	(457)	Virgin Islands (US)
HN	(424)	Honduras			

7.4.3. SOUTH AMERICA



5330		South America			
AR	(528)	Argentina	GY	(488)	Guyana
BO	(516)	Bolivia, Plurinational State of	PE	(504)	Peru
BR	(508)	Brazil	PY	(520)	Paraguay
CL	(512)	Chile	SR	(492)	Suriname
CO	(480)	Colombia	UY	(524)	Uruguay
EC	(500)	Ecuador	VE	(484)	Venezuela, Bolivarian Republic of
FK	(529)	Falkland Islands			

7.5. Asia

5400 Asia			
5410	Near and Middle Eastern countries	5490	Other Asian countries

7.5.1. NEAR AND MIDDLE EASTERN COUNTRIES

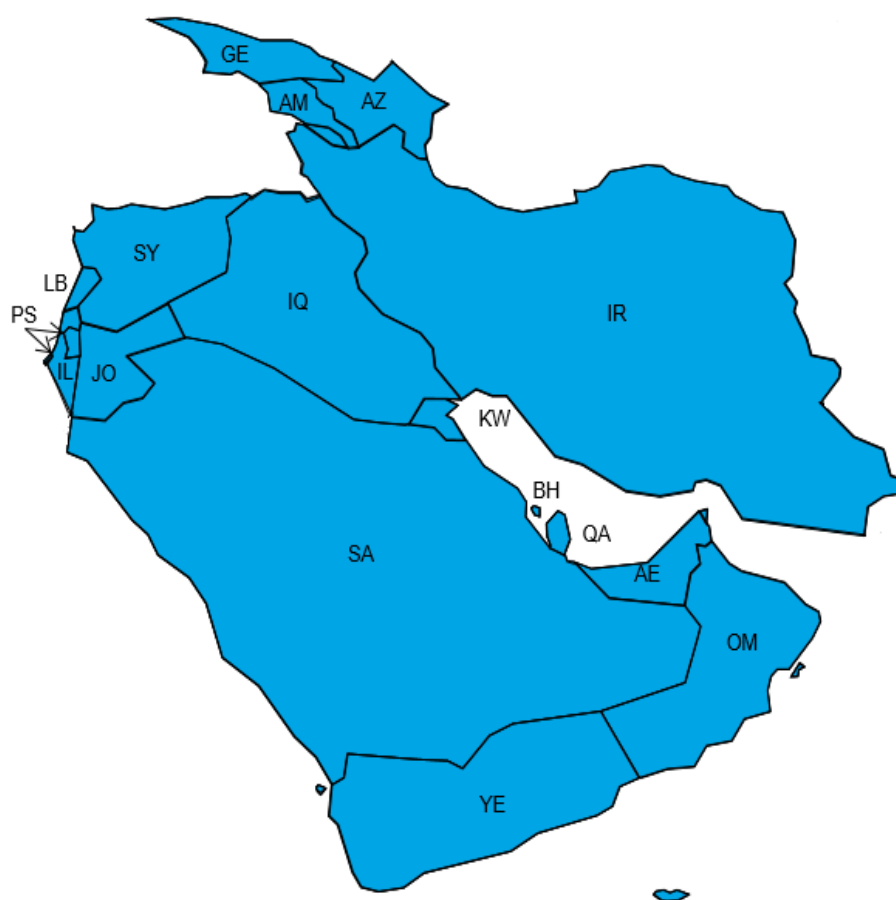

5410 Near and Middle Eastern countries					
AE	(647)	United Arab Emirates	KW	(636)	Kuwait
AM	(077)	Armenia	LB	(604)	Lebanon
AZ	(078)	Azerbaijan	OM	(649)	Oman
BH	(640)	Bahrain	PS	(625)	Palestinian Territory, Occupied
GE	(076)	Georgia	QA	(644)	Qatar
IL	(624)	Israel	SA	(632)	Saudi Arabia
IQ	(612)	Iraq	SY	(608)	Syrian Arab Republic
IR	(616)	Iran, Islamic Republic of	YE	(653)	Yemen
JO	(628)	Jordan			

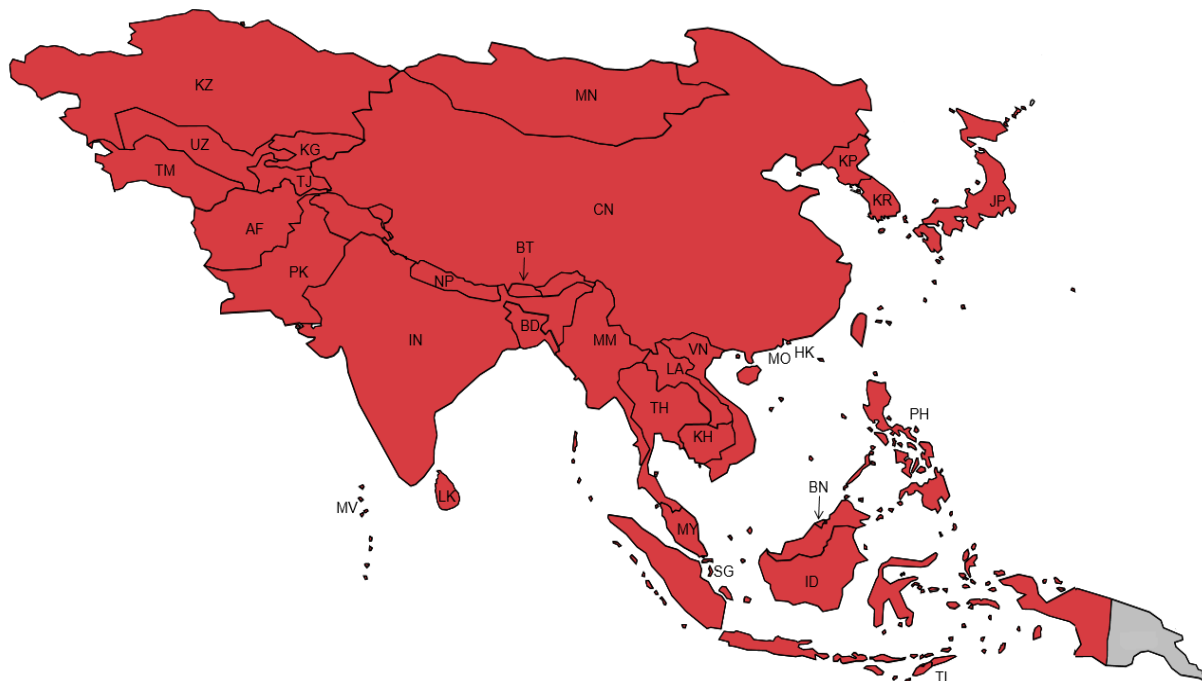
7.5.2. OTHER ASIAN COUNTRIES

5490 Other Asian countries

AF	(660)	Afghanistan	MM	(676)	Myanmar
BD	(666)	Bangladesh	MN	(716)	Mongolia
BN	(703)	Brunei Darussalam	MO	(743)	Macao
BT	(675)	Bhutan	MV	(667)	Maldives
CN	(720)	China	MY	(701)	Malaysia
HK	(740)	Hong Kong	NP	(672)	Nepal
ID	(700)	Indonesia	PH	(708)	Philippines
IN	(664)	India	PK	(662)	Pakistan
JP	(732)	Japan	SG	(706)	Singapore
KG	(083)	Kyrgyzstan	TH	(680)	Thailand
KH	(696)	Cambodia	TJ	(082)	Tajikistan
KP	(724)	Korea, Democratic People's Republic of	TL	(626)	Timor-Leste
KR	(728)	Korea, Republic of	TM	(080)	Turkmenistan
KZ	(079)	Kazakhstan	TW	(736)	Taiwan
LA	(684)	Lao People's Democratic Republic	UZ	(081)	Uzbekistan
LK	(669)	Sri Lanka	VN	(690)	Viet Nam

7.6. Oceania and Polar regions

5500 Oceania and Polar regions	
5510 Australia and New Zealand	5590 Other countries of Oceania and Polar regions

7.6.1. AUSTRALIA AND NEW ZEALAND



1. The distance to Heard Island and McDonald Islands is not to scale

5510 Australia and New Zealand			
AU (800)	Australia	NF (836)	Norfolk Island
CC (833)	Cocos (Keeling), Islands	NU (838)	Niue
CK (837)	Cook Islands	NZ (804)	New Zealand
CX (834)	Christmas Island	TK (839)	Tokelau
HM (835)	Heard Island and McDonald Islands		

7.6.2. OTHER COUNTRIES OF OCEANIA AND POLAR REGIONS

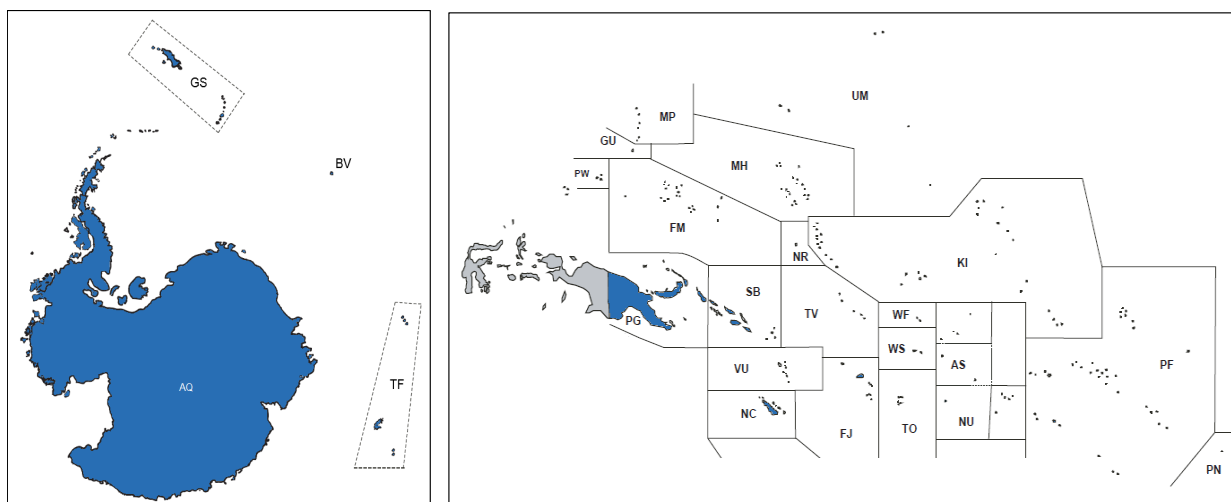

5590 Other countries of Oceania and Polar regions

AQ	(891)	Antarctica	PF	(822)	French Polynesia
AS	(830)	American Samoa	PG	(801)	Papua New Guinea
BV	(892)	Bouvet Island	PN	(813)	Pitcairn
FJ	(815)	Fiji	PW	(825)	Palau
FM	(823)	Micronesia, Federated States of	SB	(806)	Solomon Islands
GS	(893)	South Georgia and South Sandwich Islands	TF	(894)	French Southern Territories
GU	(831)	Guam	TO	(817)	Tonga
KI	(812)	Kiribati	TV	(807)	Tuvalu
MH	(824)	Marshall Islands	UM	(832)	United States Minor Outlying Islands
MP	(820)	Northern Mariana Islands	VU	(816)	Vanuatu
NC	(809)	New Caledonia	WF	(811)	Wallis and Futuna
NR	(803)	Nauru	WS	(819)	Samoa

8

Correspondence codes — zones

The table below shows to which economic and geographical zones each country code belongs.

Code		Label	Economic zones	Geographical zones
ALPHA-2	NUM			
AD	043	Andorra	1000, 1011, 1014, 2119, 2120, 2127, 2128	5000, 5100, 5190
AE	647	United Arab Emirates	1000, 1011, 1014, 1053, 2119, 2120, 2127, 2128	5000, 5400, 5410
AF	660	Afghanistan	1000, 1011, 1014, 1059, 1430, 2119, 2120, 2127, 2128	5000, 5400, 5490
AG	459	Antigua and Barbuda	1000, 1011, 1014, 1031, 2119, 2120, 2127, 2128	5000, 5300, 5320
AI	446	Anguilla	1000, 1011, 1014, 2119, 2120, 2127, 2128	5000, 5300, 5320
AL	070	Albania	1000, 1011, 1014, 1051, 1055, 1120, 1130, 2119, 2120, 2127, 2128	5000, 5100, 5190
AM	077	Armenia	1000, 1011, 1014, 1815, 2119, 2120, 2127, 2128	5000, 5400, 5410
AO	330	Angola	1000, 1011, 1014, 1031, 1430, 2119, 2120, 2127, 2128	5000, 5200, 5290
AQ	891	Antarctica	1000, 1011, 1014, 2119, 2120, 2127, 2128	5000, 5500, 5590
AR	528	Argentina	1000, 1011, 1014, 1058, 1330, 2119, 2120, 2127, 2128	5000, 5300, 5330
AS	830	American Samoa	1000, 1011, 1014, 2119, 2120, 2127, 2128	5000, 5500, 5590
AT	038	Austria	1000, 1010, 1013, 1115, 2019, 2020, 2027, 2028	5000, 5100, 5110
AU	800	Australia	1000, 1011, 1014, 1420, 1820, 2119, 2120, 2127, 2128	5000, 5500, 5510

Code		Label	Economic zones	Geographical zones
ALPHA-2	NUM			
AW	474	Aruba	1000, 1011, 1014, 2119, 2120, 2127, 2128	5000, 5300, 5320
AZ	078	Azerbaijan	1000, 1011, 1014, 1815, 2119, 2120, 2127, 2128	5000, 5400, 5410
BA	093	Bosnia and Herzegovina	1000, 1011, 1014, 1051, 1055, 1120, 1130, 2119, 2120, 2127, 2128	5000, 5100, 5190
BB	469	Barbados	1000, 1011, 1014, 1031, 2119, 2120, 2127, 2128	5000, 5300, 5320
BD	666	Bangladesh	1000, 1011, 1014, 1059, 1430, 2119, 2120, 2127, 2128	5000, 5400, 5490
BE	017	Belgium	1000, 1010, 1013, 1115, 2019, 2020, 2027, 2028	5000, 5100, 5110
BF	236	Burkina Faso	1000, 1011, 1014, 1031, 1430, 2119, 2120, 2127, 2128	5000, 5200, 5290
BG	068	Bulgaria	1000, 1010, 1014, 1115, 2027, 2028, 2119, 2120	5000, 5100, 5110
BH	640	Bahrain	1000, 1011, 1014, 2119, 2120, 2127, 2128	5000, 5400, 5410
BI	328	Burundi	1000, 1011, 1014, 1031, 1430, 2119, 2120, 2127, 2128	5000, 5200, 5290
BJ	284	Benin	1000, 1011, 1014, 1031, 1430, 2119, 2120, 2127, 2128	5000, 5200, 5290
BL	466	Saint Barthélemy	1000, 1011, 1014, 2119, 2120, 2127, 2128	5000, 5300, 5320
BM	413	Bermuda	1000, 1011, 1014, 2119, 2120, 2127, 2128	5000, 5300, 5320
BN	703	Brunei Darussalam	1000, 1011, 1014, 1057, 1420, 2119, 2120, 2127, 2128	5000, 5400, 5490
BO	516	Bolivia, Plurinational State of	1000, 1011, 1014, 1058, 1330, 2119, 2120, 2127, 2128	5000, 5300, 5330
BQ	477	Bonaire, Sint Eustatius and Saba	1000, 1011, 1014, 2119, 2120, 2127, 2128	5000, 5300, 5320
BR	508	Brazil	1000, 1011, 1014, 1058, 1330, 2119, 2120, 2127, 2128	5000, 5300, 5330
BS	453	Bahamas	1000, 1011, 1014, 1031, 2119, 2120, 2127, 2128	5000, 5300, 5320

Code		Label	Economic zones	Geographical zones
ALPHA-2	NUM			
BT	675	Bhutan	1000, 1011, 1014, 1059, 2119, 2120, 2127, 2128	5000, 5400, 5490
BV	892	Bouvet Island	1000, 1011, 1014, 2119, 2120, 2127, 2128	5000, 5500, 5590
BW	391	Botswana	1000, 1011, 1014, 1031, 2119, 2120, 2127, 2128	5000, 5200, 5290
BY	073	Belarus	1000, 1011, 1014, 1815, 2119, 2120, 2127, 2128	5000, 5100, 5190
BZ	421	Belize	1000, 1011, 1014, 1031, 2119, 2120, 2127, 2128	5000, 5300, 5320
CA	404	Canada	1000, 1011, 1014, 1310, 1420, 1820, 2119, 2120, 2127, 2128	5000, 5300, 5310
CC	833	Cocos Islands (or Keeling Islands)	1000, 1011, 1014, 2119, 2120, 2127, 2128	5000, 5500, 5510
CD	322	Congo, Democratic Republic of	1000, 1011, 1014, 1031, 1430, 2119, 2120, 2127, 2128	5000, 5200, 5290
CF	306	Central African Republic	1000, 1011, 1014, 1031, 1430, 2119, 2120, 2127, 2128	5000, 5200, 5290
CG	318	Congo	1000, 1011, 1014, 1031, 1053, 2119, 2120, 2127, 2128	5000, 5200, 5290
CH	039	Switzerland	1000, 1011, 1014, 1021, 1820, 2119, 2120, 2127, 2128	5000, 5100, 5190
CI	272	Côte d'Ivoire	1000, 1011, 1014, 1031, 2119, 2120, 2127, 2128	5000, 5200, 5290
CK	837	Cook Islands	1000, 1011, 1014, 1031, 2119, 2120, 2127, 2128	5000, 5500, 5510
CL	512	Chile	1000, 1011, 1014, 1058, 1420, 1820, 2119, 2120, 2127, 2128	5000, 5300, 5330
CM	302	Cameroon	1000, 1011, 1014, 1031, 2119, 2120, 2127, 2128	5000, 5200, 5290
CN	720	China	1000, 1011, 1014, 1420, 2119, 2120, 2127, 2128	5000, 5400, 5490
CO	480	Colombia	1000, 1011, 1014, 1058, 1820, 2119, 2120, 2127, 2128	5000, 5300, 5330
CR	436	Costa Rica	1000, 1011, 1014, 1058, 1820, 2119, 2120, 2127, 2128	5000, 5300, 5320

Code		Label	Economic zones	Geographical zones
ALPHA-2	NUM			
CU	448	Cuba	1000, 1011, 1014, 1031, 1058, 2119, 2120, 2127, 2128	5000, 5300, 5320
CV	247	Cabo Verde	1000, 1011, 1014, 1031, 2119, 2120, 2127, 2128	5000, 5200, 5290
CW	475	Curaçao	1000, 1011, 1014, 2119, 2120, 2127, 2128	5000, 5300, 5320
CX	834	Christmas Island	1000, 1011, 1014, 2119, 2120, 2127, 2128	5000, 5500, 5510
CY	600	Cyprus	1000, 1010, 1013, 1115, 2019, 2020, 2027, 2028	5000, 5100, 5110
CZ	061	Czechia	1000, 1010, 1014, 1115, 2027, 2028, 2119, 2120	5000, 5100, 5110
DE	004	Germany	1000, 1010, 1013, 1115, 2019, 2020, 2027, 2028	5000, 5100, 5110
DJ	338	Djibouti	1000, 1011, 1014, 1031, 1430, 2119, 2120, 2127, 2128	5000, 5200, 5290
DK	008	Denmark	1000, 1010, 1014, 1115, 2027, 2028, 2119, 2120	5000, 5100, 5110
DM	460	Dominica	1000, 1011, 1014, 1031, 2119, 2120, 2127, 2128	5000, 5300, 5320
DO	456	Dominican Republic	1000, 1011, 1014, 1031, 1058, 2119, 2120, 2127, 2128	5000, 5300, 5320
DZ	208	Algeria	1000, 1011, 1014, 1051, 1053, 1055, 2119, 2120, 2127, 2128	5000, 5200, 5210
EC	500	Ecuador	1000, 1011, 1014, 1058, 2119, 2120, 2127, 2128	5000, 5300, 5330
EE	053	Estonia	1000, 1010, 1013, 1115, 2019, 2020, 2027, 2028	5000, 5100, 5110
EG	220	Egypt	1000, 1011, 1014, 1051, 1055, 2119, 2120, 2127, 2128	5000, 5200, 5210
EH	229	Western Sahara	1000, 1011, 1014, 2119, 2120, 2127, 2128	5000, 5200, 5210
ER	336	Eritrea	1000, 1011, 1014, 1031, 1430, 2119, 2120, 2127, 2128	5000, 5200, 5290
ES	011	Spain	1000, 1010, 1013, 1115, 2019, 2020, 2027, 2028	5000, 5100, 5110

Code		Label	Economic zones	Geographical zones
ALPHA-2	NUM			
ET	334	Ethiopia	1000, 1011, 1014, 1031, 1430, 2119, 2120, 2127, 2128	5000, 5200, 5290
FI	032	Finland	1000, 1010, 1013, 1115, 2019, 2020, 2027, 2028	5000, 5100, 5110
FJ	815	Fiji	1000, 1011, 1014, 1031, 2119, 2120, 2127, 2128	5000, 5500, 5590
FK	529	Falkland Islands	1000, 1011, 1014, 2119, 2120, 2127, 2128	5000, 5300, 5330
FM	823	Micronesia, Federated States of	1000, 1011, 1014, 1031, 2119, 2120, 2127, 2128	5000, 5500, 5590
FO	041	Faroe Islands	1000, 1011, 1014, 2119, 2120, 2127, 2128	5000, 5100, 5190
FR	001	France	1000, 1010, 1013, 1115, 2019, 2020, 2027, 2028	5000, 5100, 5110
GA	314	Gabon	1000, 1011, 1014, 1031, 1053, 2119, 2120, 2127, 2128	5000, 5200, 5290
GB	006	United Kingdom	1000, 1011, 1014, 1820, 2028, 2119, 2120, 2127	5000, 5100, 5190
GD	473	Grenada	1000, 1011, 1014, 1031, 2119, 2120, 2127, 2128	5000, 5300, 5320
GE	076	Georgia	1000, 1011, 1014, 1130, 2119, 2120, 2127, 2128	5000, 5400, 5410
GH	276	Ghana	1000, 1011, 1014, 1031, 2119, 2120, 2127, 2128	5000, 5200, 5290
GI	044	Gibraltar	1000, 1011, 1014, 1051, 2119, 2120, 2127, 2128	5000, 5100, 5190
GL	406	Greenland	1000, 1011, 1014, 2119, 2120, 2127, 2128	5000, 5300, 5310
GM	252	Gambia	1000, 1011, 1014, 1031, 1430, 2119, 2120, 2127, 2128	5000, 5200, 5290
GN	260	Guinea	1000, 1011, 1014, 1031, 1430, 2119, 2120, 2127, 2128	5000, 5200, 5290
GQ	310	Equatorial Guinea	1000, 1011, 1014, 1031, 1053, 2119, 2120, 2127, 2128	5000, 5200, 5290
GR	009	Greece	1000, 1010, 1013, 1115, 2019, 2020, 2027, 2028	5000, 5100, 5110

Code		Label	Economic zones	Geographical zones
ALPHA-2	NUM			
GS	893	South Georgia and South Sandwich Islands	1000, 1011, 1014, 2119, 2120, 2127, 2128	5000, 5500, 5590
GT	416	Guatemala	1000, 1011, 1014, 1058, 2119, 2120, 2127, 2128	5000, 5300, 5320
GU	831	Guam	1000, 1011, 1014, 2119, 2120, 2127, 2128	5000, 5500, 5590
GW	257	Guinea-Bissau	1000, 1011, 1014, 1031, 1430, 2119, 2120, 2127, 2128	5000, 5200, 5290
GY	488	Guyana	1000, 1011, 1014, 1031, 2119, 2120, 2127, 2128	5000, 5300, 5330
HK	740	Hong Kong	1000, 1011, 1014, 1410, 1415, 1420, 2119, 2120, 2127, 2128	5000, 5400, 5490
HM	835	Heard Island and McDonald Islands	1000, 1011, 1014, 2119, 2120, 2127, 2128	5000, 5500, 5510
HN	424	Honduras	1000, 1011, 1014, 1058, 2119, 2120, 2127, 2128	5000, 5300, 5320
HR	092	Croatia	1000, 1010, 1014, 1115, 2020, 2027, 2028, 2119	5000, 5100, 5110
HT	452	Haiti	1000, 1011, 1014, 1031, 1058, 1430, 2119, 2120, 2127, 2128	5000, 5300, 5320
HU	064	Hungary	1000, 1010, 1014, 1115, 2027, 2028, 2119, 2120	5000, 5100, 5110
ID	700	Indonesia	1000, 1011, 1014, 1057, 1420, 2119, 2120, 2127, 2128	5000, 5400, 5490
IE	007	Ireland	1000, 1010, 1013, 1115, 2019, 2020, 2027, 2028	5000, 5100, 5110
IL	624	Israel	1000, 1011, 1014, 1051, 1055, 1820, 2119, 2120, 2127, 2128	5000, 5400, 5410
IN	664	India	1000, 1011, 1014, 1059, 2119, 2120, 2127, 2128	5000, 5400, 5490
IO	357	British Indian Ocean Territory	1000, 1011, 1014, 2119, 2120, 2127, 2128	5000, 5200, 5290
IQ	612	Iraq	1000, 1011, 1014, 1053, 2119, 2120, 2127, 2128	5000, 5400, 5410
IR	616	Iran, Islamic Republic of	1000, 1011, 1014, 1053, 2119, 2120, 2127, 2128	5000, 5400, 5410

Code		Label	Economic zones	Geographical zones
ALPHA-2	NUM			
IS	024	Iceland	1000, 1011, 1014, 1021, 1115, 1820, 2119, 2120, 2127, 2128	5000, 5100, 5190
IT	005	Italy	1000, 1010, 1013, 1115, 2019, 2020, 2027, 2028	5000, 5100, 5110
JM	464	Jamaica	1000, 1011, 1014, 1031, 2119, 2120, 2127, 2128	5000, 5300, 5320
JO	628	Jordan	1000, 1011, 1014, 1051, 1055, 2119, 2120, 2127, 2128	5000, 5400, 5410
JP	732	Japan	1000, 1011, 1014, 1420, 1820, 2119, 2120, 2127, 2128	5000, 5400, 5490
KE	346	Kenya	1000, 1011, 1014, 1031, 2119, 2120, 2127, 2128	5000, 5200, 5290
KG	083	Kyrgyzstan	1000, 1011, 1014, 1815, 2119, 2120, 2127, 2128	5000, 5400, 5490
KH	696	Cambodia	1000, 1011, 1014, 1057, 1430, 2119, 2120, 2127, 2128	5000, 5400, 5490
KI	812	Kiribati	1000, 1011, 1014, 1031, 1430, 2119, 2120, 2127, 2128	5000, 5500, 5590
KM	375	Comoros	1000, 1011, 1014, 1031, 1430, 2119, 2120, 2127, 2128	5000, 5200, 5290
KN	449	St Kitts and Nevis	1000, 1011, 1014, 1031, 2119, 2120, 2127, 2128	5000, 5300, 5320
KP	724	Korea, Democratic People's Republic of	1000, 1011, 1014, 2119, 2120, 2127, 2128	5000, 5400, 5490
KR	728	Korea, Republic of	1000, 1011, 1014, 1410, 1415, 1420, 1820, 2119, 2120, 2127, 2128	5000, 5400, 5490
KW	636	Kuwait	1000, 1011, 1014, 1053, 2119, 2120, 2127, 2128	5000, 5400, 5410
KY	463	Cayman Islands	1000, 1011, 1014, 2119, 2120, 2127, 2128	5000, 5300, 5320
KZ	079	Kazakhstan	1000, 1011, 1014, 1815, 2119, 2120, 2127, 2128	5000, 5400, 5490
LA	684	Lao People's Democratic Republic	1000, 1011, 1014, 1057, 1430, 2119, 2120, 2127, 2128	5000, 5400, 5490
LB	604	Lebanon	1000, 1011, 1014, 1051, 1055, 2119, 2120, 2127, 2128	5000, 5400, 5410

Code		Label	Economic zones	Geographical zones
ALPHA-2	NUM			
LC	465	St Lucia	1000, 1011, 1014, 1031, 2119, 2120, 2127, 2128	5000, 5300, 5320
LI	037	Liechtenstein	1000, 1011, 1014, 1021, 1115, 2119, 2120, 2127, 2128	5000, 5100, 5190
LK	669	Sri Lanka	1000, 1011, 1014, 1059, 2119, 2120, 2127, 2128	5000, 5400, 5490
LR	268	Liberia	1000, 1011, 1014, 1031, 1430, 2119, 2120, 2127, 2128	5000, 5200, 5290
LS	395	Lesotho	1000, 1011, 1014, 1031, 1430, 2119, 2120, 2127, 2128	5000, 5200, 5290
LT	055	Lithuania	1000, 1010, 1013, 1115, 2019, 2020, 2027, 2028	5000, 5100, 5110
LU	018	Luxembourg	1000, 1010, 1013, 1115, 2019, 2020, 2027, 2028	5000, 5100, 5110
LV	054	Latvia	1000, 1010, 1013, 1115, 2019, 2020, 2027, 2028	5000, 5100, 5110
LY	216	Libya	1000, 1011, 1014, 1051, 1053, 2119, 2120, 2127, 2128	5000, 5200, 5210
MA	204	Morocco	1000, 1011, 1014, 1051, 1055, 2119, 2120, 2127, 2128	5000, 5200, 5210
MD	074	Moldova, Republic of	1000, 1011, 1014, 1130, 1815, 2119, 2120, 2127, 2128	5000, 5100, 5190
ME	097	Montenegro	1000, 1011, 1014, 1051, 1055, 1120, 1130, 2119, 2120, 2127, 2128	5000, 5100, 5190
MG	370	Madagascar	1000, 1011, 1014, 1031, 1430, 2119, 2120, 2127, 2128	5000, 5200, 5290
MH	824	Marshall Islands	1000, 1011, 1014, 1031, 2119, 2120, 2127, 2128	5000, 5500, 5590
MK	096	North Macedonia	1000, 1011, 1014, 1051, 1055, 1120, 1130, 2119, 2120, 2127, 2128	5000, 5100, 5190
ML	232	Mali	1000, 1011, 1014, 1031, 1430, 2119, 2120, 2127, 2128	5000, 5200, 5290
MM	676	Myanmar	1000, 1011, 1014, 1057, 1430, 2119, 2120, 2127, 2128	5000, 5400, 5490
MN	716	Mongolia	1000, 1011, 1014, 2119, 2120, 2127, 2128	5000, 5400, 5490

Code		Label	Economic zones	Geographical zones
ALPHA-2	NUM			
MO	743	Macao	1000, 1011, 1014, 2119, 2120, 2127, 2128	5000, 5400, 5490
MP	820	Northern Mariana Islands	1000, 1011, 1014, 2119, 2120, 2127, 2128	5000, 5500, 5590
MR	228	Mauritania	1000, 1011, 1014, 1031, 1055, 1430, 2119, 2120, 2127, 2128	5000, 5200, 5290
MS	470	Montserrat	1000, 1011, 1014, 2119, 2120, 2127, 2128	5000, 5300, 5320
MT	046	Malta	1000, 1010, 1013, 1115, 2019, 2020, 2027, 2028	5000, 5100, 5110
MU	373	Mauritius	1000, 1011, 1014, 1031, 2119, 2120, 2127, 2128	5000, 5200, 5290
MV	667	Maldives	1000, 1011, 1014, 1059, 2119, 2120, 2127, 2128	5000, 5400, 5490
MW	386	Malawi	1000, 1011, 1014, 1031, 1430, 2119, 2120, 2127, 2128	5000, 5200, 5290
MX	412	Mexico	1000, 1011, 1014, 1058, 1310, 1420, 1820, 2119, 2120, 2127, 2128	5000, 5300, 5320
MY	701	Malaysia	1000, 1011, 1014, 1057, 1415, 1420, 2119, 2120, 2127, 2128	5000, 5400, 5490
MZ	366	Mozambique	1000, 1011, 1014, 1031, 1430, 2119, 2120, 2127, 2128	5000, 5200, 5290
NA	389	Namibia	1000, 1011, 1014, 1031, 2119, 2120, 2127, 2128	5000, 5200, 5290
NC	809	New Caledonia	1000, 1011, 1014, 2119, 2120, 2127, 2128	5000, 5500, 5590
NE	240	Niger	1000, 1011, 1014, 1031, 1430, 2119, 2120, 2127, 2128	5000, 5200, 5290
NF	836	Norfolk Island	1000, 1011, 1014, 2119, 2120, 2127, 2128	5000, 5500, 5510
NG	288	Nigeria	1000, 1011, 1014, 1031, 1053, 2119, 2120, 2127, 2128	5000, 5200, 5290
NI	432	Nicaragua	1000, 1011, 1014, 1058, 2119, 2120, 2127, 2128	5000, 5300, 5320
NL	003	Netherlands	1000, 1010, 1013, 1115, 2019, 2020, 2027, 2028	5000, 5100, 5110

Code		Label	Economic zones	Geographical zones
ALPHA-2	NUM			
NO	028	Norway	1000, 1011, 1014, 1021, 1115, 1820, 2119, 2120, 2127, 2128	5000, 5100, 5190
NP	672	Nepal	1000, 1011, 1014, 1059, 1430, 2119, 2120, 2127, 2128	5000, 5400, 5490
NR	803	Nauru	1000, 1011, 1014, 1031, 2119, 2120, 2127, 2128	5000, 5500, 5590
NU	838	Niue	1000, 1011, 1014, 1031, 2119, 2120, 2127, 2128	5000, 5500, 5510
NZ	804	New Zealand	1000, 1011, 1014, 1420, 1820, 2119, 2120, 2127, 2128	5000, 5500, 5510
OM	649	Oman	1000, 1011, 1014, 2119, 2120, 2127, 2128	5000, 5400, 5410
PA	442	Panama	1000, 1011, 1014, 1058, 2119, 2120, 2127, 2128	5000, 5300, 5320
PE	504	Peru	1000, 1011, 1014, 1058, 1420, 2119, 2120, 2127, 2128	5000, 5300, 5330
PF	822	French Polynesia	1000, 1011, 1014, 2119, 2120, 2127, 2128	5000, 5500, 5590
PG	801	Papua New Guinea	1000, 1011, 1014, 1031, 1420, 2119, 2120, 2127, 2128	5000, 5500, 5590
PH	708	Philippines	1000, 1011, 1014, 1057, 1420, 2119, 2120, 2127, 2128	5000, 5400, 5490
PK	662	Pakistan	1000, 1011, 1014, 1059, 2119, 2120, 2127, 2128	5000, 5400, 5490
PL	060	Poland	1000, 1010, 1014, 1115, 2027, 2028, 2119, 2120	5000, 5100, 5110
PM	408	St Pierre and Miquelon	1000, 1011, 1014, 2119, 2120, 2127, 2128	5000, 5300, 5310
PN	813	Pitcairn	1000, 1011, 1014, 2119, 2120, 2127, 2128	5000, 5500, 5590
PS	625	Occupied Palestinian Territory	1000, 1011, 1014, 1051, 1055, 2119, 2120, 2127, 2128	5000, 5400, 5410
PT	010	Portugal	1000, 1010, 1013, 1115, 2019, 2020, 2027, 2028	5000, 5100, 5110
PW	825	Palau	1000, 1011, 1014, 1031, 2119, 2120, 2127, 2128	5000, 5500, 5590

Code		Label	Economic zones	Geographical zones
ALPHA-2	NUM			
PY	520	Paraguay	1000, 1011, 1014, 1058, 1330, 2119, 2120, 2127, 2128	5000, 5300, 5330
QA	644	Qatar	1000, 1011, 1014, 2119, 2120, 2127, 2128	5000, 5400, 5410
QP	955	High seas	1000, 1011, 1014, 1090, 1092, 2119, 2120, 2127, 2128	5000, 5900, 5920
QQ	950	Stores and provisions	1000, 1011, 1014, 1090, 1092, 2119, 2120, 2127, 2128	5000, 5900, 5920
QR	951	Stores and provisions within the framework of intra-Union trade	1000, 1010, 1013, 1090, 1091, 1115, 2019, 2020, 2027, 2028	5000, 5100, 5110, 5900, 5910
QS	952	Stores and provisions within the framework of extra-Union trade	1000, 1011, 1014, 1090, 1092, 2119, 2120, 2127, 2128	5000, 5900, 5920
QU	958	Countries and territories not specified	1000, 1011, 1014, 1090, 1092, 2119, 2120, 2127, 2128	5000, 5900, 5920
QV	959	Countries and territories not specified within the framework of intra-Union trade	1000, 1010, 1013, 1090, 1091, 1115, 2019, 2020, 2027, 2028	5000, 5100, 5110, 5900, 5910
QW	960	Countries and territories not specified within the framework of extra-Union trade	1000, 1011, 1014, 1090, 1092, 2119, 2120, 2127, 2128	5000, 5900, 5920
QX	977	Countries and territories not specified for commercial or military reasons	1000, 1011, 1014, 1090, 1092, 2119, 2120, 2127, 2128	5000, 5900, 5920
QY	978	Countries and territories not specified for commercial or military reasons in the framework of intra-Union trade	1000, 1010, 1013, 1090, 1091, 1115, 2019, 2020, 2027, 2028	5000, 5100, 5110, 5900, 5910
QZ	979	Countries and territories not specified for commercial or military reasons in the framework of extra-Union trade	1000, 1011, 1014, 1090, 1092, 2119, 2120, 2127, 2128	5000, 5900, 5920
RO	066	Romania	1000, 1010, 1014, 1115, 2027, 2028, 2119, 2120	5000, 5100, 5110
RU	075	Russian Federation	1000, 1011, 1014, 1420, 1815, 2119, 2120, 2127, 2128	5000, 5100, 5190
RW	324	Rwanda	1000, 1011, 1014, 1031, 1430, 2119, 2120, 2127, 2128	5000, 5200, 5290
SA	632	Saudi Arabia	1000, 1011, 1014, 1053, 2119, 2120, 2127, 2128	5000, 5400, 5410

Code		Label	Economic zones	Geographical zones
ALPHA-2	NUM			
SB	806	Solomon Islands	1000, 1011, 1014, 1031, 1430, 2119, 2120, 2127, 2128	5000, 5500, 5590
SC	355	Seychelles	1000, 1011, 1014, 1031, 2119, 2120, 2127, 2128	5000, 5200, 5290
SD	224	Sudan	1000, 1011, 1014, 1031, 1430, 2119, 2120, 2127, 2128	5000, 5200, 5290
SE	030	Sweden	1000, 1010, 1014, 1115, 2027, 2028, 2119, 2120	5000, 5100, 5110
SG	706	Singapore	1000, 1011, 1014, 1057, 1410, 1415, 1420, 2119, 2120, 2127, 2128	5000, 5400, 5490
SH	329	Saint Helena, Ascension and Tristan da Cunha	1000, 1011, 1014, 2119, 2120, 2127, 2128	5000, 5200, 5290
SI	091	Slovenia	1000, 1010, 1013, 1115, 2019, 2020, 2027, 2028	5000, 5100, 5110
SK	063	Slovakia	1000, 1010, 1013, 1115, 2019, 2020, 2027, 2028	5000, 5100, 5110
SL	264	Sierra Leone	1000, 1011, 1014, 1031, 1430, 2119, 2120, 2127, 2128	5000, 5200, 5290
SM	047	San Marino	1000, 1011, 1014, 2119, 2120, 2127, 2128	5000, 5100, 5190
SN	248	Senegal	1000, 1011, 1014, 1031, 1430, 2119, 2120, 2127, 2128	5000, 5200, 5290
SO	342	Somalia	1000, 1011, 1014, 1031, 1430, 2119, 2120, 2127, 2128	5000, 5200, 5290
SR	492	Suriname	1000, 1011, 1014, 1031, 2119, 2120, 2127, 2128	5000, 5300, 5330
SS	225	South Sudan	1000, 1011, 1014, 1430, 2119, 2120, 2127, 2128	5000, 5200, 5290
ST	311	Sao Tome and Principe	1000, 1011, 1014, 1031, 1430, 2119, 2120, 2127, 2128	5000, 5200, 5290
SV	428	El Salvador	1000, 1011, 1014, 1058, 2119, 2120, 2127, 2128	5000, 5300, 5320
SX	479	Sint Maarten (Dutch part)	1000, 1011, 1014, 2119, 2120, 2127, 2128	5000, 5300, 5320
SY	608	Syrian Arab Republic	1000, 1011, 1014, 1051, 1055, 2119, 2120, 2127, 2128	5000, 5400, 5410

Code		Label	Economic zones	Geographical zones
ALPHA-2	NUM			
SZ	393	Eswatini	1000, 1011, 1014, 1031, 2119, 2120, 2127, 2128	5000, 5200, 5290
TC	454	Turks and Caicos Islands	1000, 1011, 1014, 2119, 2120, 2127, 2128	5000, 5300, 5320
TD	244	Chad	1000, 1011, 1014, 1031, 1430, 2119, 2120, 2127, 2128	5000, 5200, 5290
TF	894	French Southern Territories	1000, 1011, 1014, 2119, 2120, 2127, 2128	5000, 5500, 5590
TG	280	Togo	1000, 1011, 1014, 1031, 1430, 2119, 2120, 2127, 2128	5000, 5200, 5290
TH	680	Thailand	1000, 1011, 1014, 1057, 1415, 1420, 2119, 2120, 2127, 2128	5000, 5400, 5490
TJ	082	Tajikistan	1000, 1011, 1014, 1815, 2119, 2120, 2127, 2128	5000, 5400, 5490
TK	839	Tokelau	1000, 1011, 1014, 2119, 2120, 2127, 2128	5000, 5500, 5510
TL	626	Timor-Leste	1000, 1011, 1014, 1031, 1430, 2119, 2120, 2127, 2128	5000, 5400, 5490
TM	080	Turkmenistan	1000, 1011, 1014, 1815, 2119, 2120, 2127, 2128	5000, 5400, 5490
TN	212	Tunisia	1000, 1011, 1014, 1051, 1055, 2119, 2120, 2127, 2128	5000, 5200, 5210
TO	817	Tonga	1000, 1011, 1014, 1031, 2119, 2120, 2127, 2128	5000, 5500, 5590
TR	052	Türkiye	1000, 1011, 1014, 1051, 1055, 1130, 1820, 2119, 2120, 2127, 2128	5000, 5100, 5190
TT	472	Trinidad and Tobago	1000, 1011, 1014, 1031, 2119, 2120, 2127, 2128	5000, 5300, 5320
TV	807	Tuvalu	1000, 1011, 1014, 1031, 1430, 2119, 2120, 2127, 2128	5000, 5500, 5590
TW	736	Taiwan	1000, 1011, 1014, 1410, 1415, 1420, 2119, 2120, 2127, 2128	5000, 5400, 5490
TZ	352	Tanzania, United Republic of	1000, 1011, 1014, 1031, 1430, 2119, 2120, 2127, 2128	5000, 5200, 5290
UA	072	Ukraine	1000, 1011, 1014, 1130, 2119, 2120, 2127, 2128	5000, 5100, 5190

Code		Label	Economic zones	Geographical zones
ALPHA-2	NUM			
UG	350	Uganda	1000, 1011, 1014, 1031, 1430, 2119, 2120, 2127, 2128	5000, 5200, 5290
UM	832	United States Minor Outlying Islands	1000, 1011, 1014, 2119, 2120, 2127, 2128	5000, 5500, 5590
US	400	United States	1000, 1011, 1014, 1310, 1420, 1820, 2119, 2120, 2127, 2128	5000, 5300, 5310
UY	524	Uruguay	1000, 1011, 1014, 1058, 1330, 2119, 2120, 2127, 2128	5000, 5300, 5330
UZ	081	Uzbekistan	1000, 1011, 1014, 1815, 2119, 2120, 2127, 2128	5000, 5400, 5490
VA	045	Holy See	1000, 1011, 1014, 2119, 2120, 2127, 2128	5000, 5100, 5190
VC	467	St Vincent and the Grenadines	1000, 1011, 1014, 1031, 2119, 2120, 2127, 2128	5000, 5300, 5320
VE	484	Venezuela, Bolivarian Republic of	1000, 1011, 1014, 1053, 1058, 2119, 2120, 2127, 2128	5000, 5300, 5330
VG	468	Virgin Islands, British	1000, 1011, 1014, 2119, 2120, 2127, 2128	5000, 5300, 5320
VI	457	Virgin Islands, United States	1000, 1011, 1014, 1820, 2119, 2120, 2127, 2128	5000, 5300, 5320
VN	690	Viet Nam	1000, 1011, 1014, 1057, 1420, 2119, 2120, 2127, 2128	5000, 5400, 5490
VU	816	Vanuatu	1000, 1011, 1014, 1031, 2119, 2120, 2127, 2128	5000, 5500, 5590
WF	811	Wallis and Futuna	1000, 1011, 1014, 2119, 2120, 2127, 2128	5000, 5500, 5590
WS	819	Samoa	1000, 1011, 1014, 1031, 2119, 2120, 2127, 2128	5000, 5500, 5590
XC	021	Ceuta	1000, 1011, 1014, 1051, 2119, 2120, 2127, 2128	5000, 5200, 5210
XK	095	Kosovo	1000, 1011, 1014, 1051, 1120, 2119, 2120, 2127, 2128	5000, 5100, 5190
XL	023	Melilla	1000, 1011, 1014, 1051, 2119, 2120, 2127, 2128	5000, 5200, 5210
XS	098	Serbia	1000, 1011, 1014, 1051, 1120, 1130, 2119, 2120, 2127, 2128	5000, 5100, 5190

Code		Label	Economic zones	Geographical zones
ALPHA-2	NUM			
YE	653	Yemen	1000, 1011, 1014, 1430, 2119, 2120, 2127, 2128	5000, 5400, 5410
ZA	388	South Africa	1000, 1011, 1014, 1031, 2119, 2120, 2127, 2128	5000, 5200, 5290
ZM	378	Zambia	1000, 1011, 1014, 1031, 1430, 2119, 2120, 2127, 2128	5000, 5200, 5290
ZW	382	Zimbabwe	1000, 1011, 1014, 1031, 2119, 2120, 2127, 2128	5000, 5200, 5290

9

Correspondence ISO 3166 — Geonomenclature

This chapter documents the similarities and differences between the ISO 3166 standard and the Geonomenclature on the basis of the following flags:

- * = Full correspondence
- + = Partial correspondence
- ** = ISO 3166 code classified under a different Geonomenclature code
- >>> = Geonomenclature codes with no correspondence in ISO 3166

The Geonomenclature matches with the ISO 3166 for most countries. Out of the 249 ISO 3166 codes, 229 codes have a full correspondence. There is only a partial correspondence for seven codes and 13 codes are classified under a different Geonomenclature code.

9.1. From ISO 3166 to Geonomenclature

Note	ISO 3166			Geonomenclature			Comments
	ALPHA-2	NUM	Label	ALPHA-2	NUM	Label	
*	AD	020	Andorra	AD	043	Andorra	
*	AE	784	United Arab Emirates (the)	AE	647	United Arab Emirates	
*	AF	004	Afghanistan	AF	660	Afghanistan	
*	AG	028	Antigua and Barbuda	AG	459	Antigua and Barbuda	
*	AI	660	Anguilla	AI	446	Anguilla	
*	AL	008	Albania	AL	070	Albania	
*	AM	051	Armenia	AM	077	Armenia	
*	AO	024	Angola	AO	330	Angola	
*	AQ	010	Antarctica	AQ	891	Antarctica	
*	AR	032	Argentina	AR	528	Argentina	
*	AS	016	American Samoa	AS	830	American Samoa	
*	AT	040	Austria	AT	038	Austria	
*	AU	036	Australia	AU	800	Australia	
*	AW	533	Aruba	AW	474	Aruba	
**	AX	248	Åland Islands	FI	032	Finland	See the ISO3166 code 'FI'
*	AZ	031	Azerbaijan	AZ	078	Azerbaijan	
*	BA	070	Bosnia and Herzegovina	BA	093	Bosnia and Herzegovina	
*	BB	052	Barbados	BB	469	Barbados	
*	BD	050	Bangladesh	BD	666	Bangladesh	
*	BE	056	Belgium	BE	017	Belgium	
*	BF	854	Burkina Faso	BF	236	Burkina Faso	
*	BG	100	Bulgaria	BG	068	Bulgaria	
*	BH	048	Bahrain	BH	640	Bahrain	
*	BI	108	Burundi	BI	328	Burundi	

Note	ISO 3166			Geonomenclature			Comments
	ALPHA-2	NUM	Label	ALPHA-2	NUM	Label	
*	BJ	204	Benin	BJ	284	Benin	
*	BL	652	Saint Barthélemy	BL	466	Saint Barthélemy	
*	BM	060	Bermuda	BM	413	Bermuda	
*	BN	096	Brunei Darussalam	BN	703	Brunei Darussalam	
*	BO	068	Bolivia (Plurinational State of)	BO	516	Bolivia, Plurinational State of	
*	BQ	535	Bonaire, Sint Eustatius and Saba	BQ	477	Bonaire, Sint Eustatius and Saba	
*	BR	076	Brazil	BR	508	Brazil	
*	BS	044	Bahamas (the)	BS	453	Bahamas	
*	BT	064	Bhutan	BT	675	Bhutan	
*	BV	074	Bouvet Island	BV	892	Bouvet Island	
*	BW	072	Botswana	BW	391	Botswana	
*	BY	112	Belarus	BY	073	Belarus	
*	BZ	084	Belize	BZ	421	Belize	
*	CA	124	Canada	CA	404	Canada	
*	CC	166	Cocos (Keeling) Islands (the)	CC	833	Cocos Islands (or Keeling Islands)	
*	CD	180	Congo (the Democratic Republic of the)	CD	322	Congo, Democratic Republic of	
*	CF	140	Central African Republic (the)	CF	306	Central African Republic	
*	CG	178	Congo (the)	CG	318	Congo	
*	CH	756	Switzerland	CH	039	Switzerland	
*	CI	384	Côte d'Ivoire	CI	272	Côte d'Ivoire	
*	CK	184	Cook Islands (the)	CK	837	Cook Islands	
*	CL	152	Chile	CL	512	Chile	
*	CM	120	Cameroon	CM	302	Cameroon	
*	CN	156	China	CN	720	China	
*	CO	170	Colombia	CO	480	Colombia	
*	CR	188	Costa Rica	CR	436	Costa Rica	
*	CU	192	Cuba	CU	448	Cuba	
*	CV	132	Cabo Verde	CV	247	Cabo Verde	
*	CW	531	Curaçao	CW	475	Curaçao	
*	CX	162	Christmas Island	CX	834	Christmas Island	
*	CY	196	Cyprus	CY	600	Cyprus	
*	CZ	203	Czechia	CZ	061	Czechia	
*	DE	276	Germany	DE	004	Germany	
*	DJ	262	Djibouti	DJ	338	Djibouti	
*	DK	208	Denmark	DK	008	Denmark	
*	DM	212	Dominica	DM	460	Dominica	
*	DO	214	Dominican Republic (the)	DO	456	Dominican Republic	
*	DZ	012	Algeria	DZ	208	Algeria	
*	EC	218	Ecuador	EC	500	Ecuador	
*	EE	233	Estonia	EE	053	Estonia	
*	EG	818	Egypt	EG	220	Egypt	
*	EH	732	Western Sahara*	EH	229	Western Sahara	
*	ER	232	Eritrea	ER	336	Eritrea	
+	ES	724	Spain	ES	011	Spain	Code ES of the Geonomenclature including the Balearic Islands and the Canary Islands but excluding Ceuta (XC) and Melilla (XL)

Note	ISO 3166			Geonomenclature			Comments
	ALPHA-2	NUM	Label	ALPHA-2	NUM	Label	
*	ET	231	Ethiopia	ET	334	Ethiopia	
+	FI	246	Finland	FI	032	Finland	Code FI including the Åland Islands according to the Geonomenclature; See Åland Islands (AX) in ISO3166 nomenclature
*	FJ	242	Fiji	FJ	815	Fiji	
*	FK	238	Falkland Islands (the) [Malvinas]	FK	529	Falkland Islands	
*	FM	583	Micronesia (Federated States of)	FM	823	Micronesia, Federated States of	
*	FO	234	Faroe Islands (the)	FO	041	Faroe Islands	
+	FR	250	France	FR	001	France	Code FR including Monaco, the French overseas departments (French Guiana, Guadeloupe, Martinique, Mayotte and Réunion) and the French northern part of St Martin according to the Geonomenclature; See French Guiana (GF), Guadeloupe (GP), Martinique (MQ), Mayotte (YT), Monaco (MC), Réunion (RE) and the French northern part of St Martin (MF) in ISO3166 nomenclature
*	GA	266	Gabon	GA	314	Gabon	
+	GB	826	United Kingdom of Great Britain and Northern Ireland (the)	GB	006	United Kingdom	Code GB including Great Britain, Northern Ireland, Channel Islands and Isle of Man according to the Geonomenclature; See Jersey (JE), Guernsey (GG) and Isle of Man (IM) in ISO3166 nomenclature
*	GD	308	Grenada	GD	473	Grenada	
*	GE	268	Georgia	GE	076	Georgia	
**	GF	254	French Guiana	FR	001	France	See the ISO3166 code 'FR'
**	GG	831	Guernsey	GB	006	United Kingdom	See the ISO3166 code 'GB'
*	GH	288	Ghana	GH	276	Ghana	
*	GI	292	Gibraltar	GI	044	Gibraltar	
*	GL	304	Greenland	GL	406	Greenland	
*	GM	270	Gambia (the)	GM	252	Gambia	
*	GN	324	Guinea	GN	260	Guinea	
**	GP	312	Guadeloupe	FR	001	France	See the ISO3166 code 'FR'
*	GQ	226	Equatorial Guinea	GQ	310	Equatorial Guinea	
*	GR	300	Greece	GR	009	Greece	
*	GS	239	South Georgia and the South Sandwich Islands	GS	893	South Georgia and South Sandwich Islands	
*	GT	320	Guatemala	GT	416	Guatemala	
*	GU	316	Guam	GU	831	Guam	
*	GW	624	Guinea-Bissau	GW	257	Guinea-Bissau	
*	GY	328	Guyana	GY	488	Guyana	
*	HK	344	Hong Kong	HK	740	Hong Kong	
*	HM	334	Heard Island and McDonald Islands	HM	835	Heard Island and McDonald Islands	
*	HN	340	Honduras	HN	424	Honduras	

Note	ISO 3166			Geonomenclature			Comments
	ALPHA-2	NUM	Label	ALPHA-2	NUM	Label	
*	HR	191	Croatia	HR	092	Croatia	
*	HT	332	Haiti	HT	452	Haiti	
*	HU	348	Hungary	HU	064	Hungary	
*	ID	360	Indonesia	ID	700	Indonesia	
*	IE	372	Ireland	IE	007	Ireland	
*	IL	376	Israel	IL	624	Israel	
**	IM	833	Isle of Man	GB	006	United Kingdom	See the ISO3166 code 'GB'
*	IN	356	India	IN	664	India	
*	IO	086	British Indian Ocean Territory (the)	IO	357	British Indian Ocean Territory	
*	IQ	368	Iraq	IQ	612	Iraq	
*	IR	364	Iran (Islamic Republic of)	IR	616	Iran, Islamic Republic of	
*	IS	352	Iceland	IS	024	Iceland	
*	IT	380	Italy	IT	005	Italy	
**	JE	832	Jersey	GB	006	United Kingdom	See the ISO3166 code 'GB'
*	JM	388	Jamaica	JM	464	Jamaica	
*	JO	400	Jordan	JO	628	Jordan	
*	JP	392	Japan	JP	732	Japan	
*	KE	404	Kenya	KE	346	Kenya	
*	KG	417	Kyrgyzstan	KG	083	Kyrgyzstan	
*	KH	116	Cambodia	KH	696	Cambodia	
*	KI	296	Kiribati	KI	812	Kiribati	
*	KM	174	Comoros (the)	KM	375	Comoros	
*	KN	659	Saint Kitts and Nevis	KN	449	St Kitts and Nevis	
*	KP	408	Korea (the Democratic People's Republic of)	KP	724	Korea, Democratic People's Republic of	
*	KR	410	Korea (the Republic of)	KR	728	Korea, Republic of	
*	KW	414	Kuwait	KW	636	Kuwait	
*	KY	136	Cayman Islands (the)	KY	463	Cayman Islands	
*	KZ	398	Kazakhstan	KZ	079	Kazakhstan	
*	LA	418	Lao People's Democratic Republic (the)	LA	684	Lao People's Democratic Republic	
*	LB	422	Lebanon	LB	604	Lebanon	
*	LC	662	Saint Lucia	LC	465	St Lucia	
*	LI	438	Liechtenstein	LI	037	Liechtenstein	
*	LK	144	Sri Lanka	LK	669	Sri Lanka	
*	LR	430	Liberia	LR	268	Liberia	
*	LS	426	Lesotho	LS	395	Lesotho	
*	LT	440	Lithuania	LT	055	Lithuania	
*	LU	442	Luxembourg	LU	018	Luxembourg	
*	LV	428	Latvia	LV	054	Latvia	
*	LY	434	Libya	LY	216	Libya	
*	MA	504	Morocco	MA	204	Morocco	
**	MC	492	Monaco	FR	001	France	See the ISO3166 code 'FR'
*	MD	498	Moldova (the Republic of)	MD	074	Moldova, Republic of	
*	ME	499	Montenegro	ME	097	Montenegro	
**	MF	663	Saint Martin (French part)	FR	001	France	See the ISO3166 code 'FR'
*	MG	450	Madagascar	MG	370	Madagascar	
*	MH	584	Marshall Islands (the)	MH	824	Marshall Islands	

Note	ISO 3166			Geonomenclature			Comments
	ALPHA-2	NUM	Label	ALPHA-2	NUM	Label	
*	MK	807	North Macedonia	MK	096	North Macedonia	
*	ML	466	Mali	ML	232	Mali	
*	MM	104	Myanmar	MM	676	Myanmar	
*	MN	496	Mongolia	MN	716	Mongolia	
*	MO	446	Macao	MO	743	Macao	
*	MP	580	Northern Mariana Islands (the)	MP	820	Northern Mariana Islands	
**	MQ	474	Martinique	FR	001	France	See the ISO3166 code 'FR'
*	MR	478	Mauritania	MR	228	Mauritania	
*	MS	500	Montserrat	MS	470	Montserrat	
*	MT	470	Malta	MT	046	Malta	
*	MU	480	Mauritius	MU	373	Mauritius	
*	MV	462	Maldives	MV	667	Maldives	
*	MW	454	Malawi	MW	386	Malawi	
*	MX	484	Mexico	MX	412	Mexico	
*	MY	458	Malaysia	MY	701	Malaysia	
*	MZ	508	Mozambique	MZ	366	Mozambique	
*	NA	516	Namibia	NA	389	Namibia	
*	NC	540	New Caledonia	NC	809	New Caledonia	
*	NE	562	Niger (the)	NE	240	Niger	
*	NF	574	Norfolk Island	NF	836	Norfolk Island	
*	NG	566	Nigeria	NG	288	Nigeria	
*	NI	558	Nicaragua	NI	432	Nicaragua	
*	NL	528	Netherlands (Kingdom of the)	NL	003	Netherlands	
+	NO	578	Norway	NO	028	Norway	Code NO including Svalbard Archipelago and Jan Mayen Island according to the Geonomenclature; See Svalbard and Jan Mayen (SJ) in ISO3166 nomenclature
*	NP	524	Nepal	NP	672	Nepal	
*	NR	520	Nauru	NR	803	Nauru	
*	NU	570	Niue	NU	838	Niue	
*	NZ	554	New Zealand	NZ	804	New Zealand	
*	OM	512	Oman	OM	649	Oman	
*	PA	591	Panama	PA	442	Panama	
*	PE	604	Peru	PE	504	Peru	
*	PF	258	French Polynesia	PF	822	French Polynesia	
*	PG	598	Papua New Guinea	PG	801	Papua New Guinea	
*	PH	608	Philippines (the)	PH	708	Philippines	
*	PK	586	Pakistan	PK	662	Pakistan	
*	PL	616	Poland	PL	060	Poland	
*	PM	666	Saint Pierre and Miquelon	PM	408	St Pierre and Miquelon	
*	PN	612	Pitcairn	PN	813	Pitcairn	
**	PR	630	Puerto Rico	US	400	United States	See the ISO3166 code 'US'
*	PS	275	Palestine, State of	PS	625	Occupied Palestinian Territory	
*	PT	620	Portugal	PT	010	Portugal	
*	PW	585	Palau	PW	825	Palau	
*	PY	600	Paraguay	PY	520	Paraguay	
*	QA	634	Qatar	QA	644	Qatar	
**	RE	638	Réunion	FR	001	France	See the ISO3166 code 'FR'
*	RO	642	Romania	RO	066	Romania	

Note	ISO 3166			Geonomenclature			Comments
	ALPHA-2	NUM	Label	ALPHA-2	NUM	Label	
+	RS	688	Serbia	XS	098	Serbia	Code XS excluding Kosovo (XK) according to the Geonomenclature; Code RS used in ISO3166 nomenclature including Kosovo
*	RU	643	Russian Federation (the)	RU	075	Russian Federation	
*	RW	646	Rwanda	RW	324	Rwanda	
*	SA	682	Saudi Arabia	SA	632	Saudi Arabia	
*	SB	090	Solomon Islands	SB	806	Solomon Islands	
*	SC	690	Seychelles	SC	355	Seychelles	
*	SD	729	Sudan (the)	SD	224	Sudan	
*	SE	752	Sweden	SE	030	Sweden	
*	SG	702	Singapore	SG	706	Singapore	
*	SH	654	Saint Helena, Ascension and Tristan da Cunha	SH	329	Saint Helena, Ascension and Tristan da Cunha	
*	SI	705	Slovenia	SI	091	Slovenia	
**	SJ	744	Svalbard and Jan Mayen	NO	028	Norway	See the ISO3166 code 'NO'
*	SK	703	Slovakia	SK	063	Slovakia	
*	SL	694	Sierra Leone	SL	264	Sierra Leone	
*	SM	674	San Marino	SM	047	San Marino	
*	SN	686	Senegal	SN	248	Senegal	
*	SO	706	Somalia	SO	342	Somalia	
*	SR	740	Suriname	SR	492	Suriname	
*	SS	728	South Sudan	SS	225	South Sudan	
*	ST	678	Sao Tome and Principe	ST	311	Sao Tome and Principe	
*	SV	222	El Salvador	SV	428	El Salvador	
*	SX	534	Sint Maarten (Dutch part)	SX	479	Sint Maarten (Dutch part)	
*	SY	760	Syrian Arab Republic (the)	SY	608	Syrian Arab Republic	
*	SZ	748	Eswatini	SZ	393	Eswatini	
*	TC	796	Turks and Caicos Islands (the)	TC	454	Turks and Caicos Islands	
*	TD	148	Chad	TD	244	Chad	
*	TF	260	French Southern Territories (the)	TF	894	French Southern Territories	
*	TG	768	Togo	TG	280	Togo	
*	TH	764	Thailand	TH	680	Thailand	
*	TJ	762	Tajikistan	TJ	082	Tajikistan	
*	TK	772	Tokelau	TK	839	Tokelau	
*	TL	626	Timor-Leste	TL	626	Timor-Leste	
*	TM	795	Turkmenistan	TM	080	Turkmenistan	
*	TN	788	Tunisia	TN	212	Tunisia	
*	TO	776	Tonga	TO	817	Tonga	
*	TR	792	Türkiye	TR	052	Türkiye	
*	TT	780	Trinidad and Tobago	TT	472	Trinidad and Tobago	
*	TV	798	Tuvalu	TV	807	Tuvalu	
*	TW	158	Taiwan (Province of China)	TW	736	Taiwan	

Note	ISO 3166			Geonomenclature			Comments
	ALPHA-2	NUM	Label	ALPHA-2	NUM	Label	
*	TZ	834	Tanzania, the United Republic of	TZ	352	Tanzania, United Republic of	
*	UA	804	Ukraine	UA	072	Ukraine	
*	UG	800	Uganda	UG	350	Uganda	
*	UM	581	United States Minor Outlying Islands (the)	UM	832	United States Minor Outlying Islands	
+	US	840	United States of America (the)	US	400	United States	Code US including Puerto Rico according to the Geonomenclature
*	UY	858	Uruguay	UY	524	Uruguay	
*	UZ	860	Uzbekistan	UZ	081	Uzbekistan	
*	VA	336	Holy See (the)	VA	045	Holy See	
*	VC	670	Saint Vincent and the Grenadines	VC	467	St Vincent and the Grenadines	
*	VE	862	Venezuela (Bolivarian Republic of)	VE	484	Venezuela, Bolivarian Republic of	
*	VG	092	Virgin Islands (British)	VG	468	Virgin Islands, British	
*	VI	850	Virgin Islands (U.S.)	VI	457	Virgin Islands, United States	
*	VN	704	Viet Nam	VN	690	Viet Nam	
*	VU	548	Vanuatu	VU	816	Vanuatu	
*	WF	876	Wallis and Futuna	WF	811	Wallis and Futuna	
*	WS	882	Samoa	WS	819	Samoa	
*	YE	887	Yemen	YE	653	Yemen	
**	YT	175	Mayotte	FR	001	France	Code FR including Monaco, the French overseas departments (French Guiana, Guadeloupe, Martinique, Mayotte and Réunion) and the French northern part of St Martin according to the Geonomenclature.
*	ZA	710	South Africa	ZA	388	South Africa	
*	ZM	894	Zambia	ZM	378	Zambia	
*	ZW	716	Zimbabwe	ZW	382	Zimbabwe	

9.2. ISO 3166 codes not existing in Geonomenclature

Note	ISO 3166 nomenclature			Comments
	ALPHA-2	NUM	Label	
**	AX	248	Åland Islands	Included under code FI (Finland) of the Geonomenclature
**	GF	254	French Guiana	Included under code FR (France) of the Geonomenclature
**	GG	831	Guernsey	Included under code GB (United Kingdom) of the Geonomenclature
**	GP	312	Guadeloupe	Included under code FR (France) of the Geonomenclature
**	IM	833	Isle of Man	Included under code GB (United Kingdom) of the Geonomenclature
**	JE	832	Jersey	Included under code GB (United Kingdom) of the Geonomenclature
**	MC	492	Monaco	Included under code FR (France) of the Geonomenclature
**	MF	663	Saint Martin (French part)	Included under code FR (France) of the Geonomenclature
**	MQ	474	Martinique	Included under code FR (France) of the Geonomenclature
**	PR	630	Puerto Rico	Included under code US (United States) of the Geonomenclature
**	RE	638	Réunion	Included under code FR (France) of the Geonomenclature
**	SJ	744	Svalbard and Jan Mayen	Included under code NO (Norway) of the Geonomenclature
**	YT	175	Mayotte	Included under code FR (France) of the Geonomenclature

9.3. Geonomenclature codes not existing in ISO 3166

Note	Geonomenclature			Comments
	ALPHA-2	NUM	Label	
>>>	EU	999	European Union	Code reserved, in extra-Union trade, for the declaration of the origin of goods according to the conditions laid down in the relevant Union provisions. Code not to be used for statistical purposes.
>>>	QP	955	High seas	Maritime domain outside of territorial waters
>>>	QQ	950	Stores and provisions	Code for the purpose of deliveries to vessels and aircraft
>>>	or			
>>>	QR	951	Stores and provisions within the framework of intra-Union trade	Code for the purpose of deliveries to vessels and aircraft
>>>	QS	952	Stores and provisions within the framework of extra-Union trade	Code for the purpose of deliveries to vessels and aircraft
>>>	QU	958	Countries and territories not specified	
>>>	or			
>>>	QV	959	Countries and territories not specified within the framework of intra-Union trade	
>>>	QW	960	Countries and territories not specified within the framework of extra-Union trade	

Note	Geonomenclature			Comments
	ALPHA-2	NUM	Label	
>>>	QX	977	Countries and territories not specified for commercial or military reasons	
	or			
>>>	QY	978	Countries and territories not specified for commercial or military reasons in the framework of intra-Union trade	
>>>	QZ	979	Countries and territories not specified for commercial or military reasons in the framework of extra-Union trade	
>>>	XC	021	Ceuta	
>>>	XI	015	United Kingdom (Northern Ireland)	Code to be used if United Kingdom (in respect of Northern Ireland) needs to be distinguished according to the conditions laid down in the relevant Union provisions.
>>>	XK	095	Kosovo	This designation is without prejudice to positions on status, and is in line with UNSCR 1244/1999 and the ICJ Opinion on the Kosovo declaration of independence
>>>	XL	023	Melilla	Including Peñón de Vélez de la Gomera, Peñón de Alhucemas and Chafarinas Islands.
+	XS	098	Serbia	Excluding Kosovo
>>>	XU	016	United Kingdom (excluding Northern Ireland)	Code to be used if United Kingdom (excluding Northern Ireland) needs to be distinguished according to the conditions laid down in the relevant Union provisions.

10

Link to Eurostat's online database (data navigation tree) code list

10.1. Use of Eurostat's online database code list

The geopolitical entities (reporting and partner countries) included in the 'Aggregated data', 'Trade by enterprise characteristics' and 'Trade by invoicing currency' datasets accessible via Eurostat's Data Navigation Tree are classified according to Eurostat's online database code list. The EU Member States are listed alphabetically using their source language. The so-called protocol order is based on the Roman alphabetical order of their geographical names in source language(s).

Short name, in source language(s) (geographical name) ⁽¹⁾	Official name, in source language(s) (protocol name)	Short name in English (geographical name)	Official name in English (protocol name)	Country code ⁽²⁾	Former abbreviation ⁽²⁾
Belgique/België	Royaume de Belgique/ Koninkrijk België	Belgium	Kingdom of Belgium	BE	B
България (*)	Република България	Bulgaria	Republic of Bulgaria	BG	—
Česko	Česká republika	Czechia	Czech Republic	CZ	—
Danmark	Kongeriget Danmark	Denmark	Kingdom of Denmark	DK	DK
Deutschland	Bundesrepublik Deutschland	Germany	Federal Republic of Germany	DE	D
Eesti	Eesti Vabariik	Estonia	Republic of Estonia	EE	—
Éire/Ireland	Éire/Ireland	Ireland	Ireland	IE	IRL
Ελλάδα (*)	Ελληνική Δημοκρατία	Greece	Hellenic Republic	EL	EL
España	Reino de España	Spain	Kingdom of Spain	ES	E
France	République française	France	French Republic	FR	F
Hrvatska	Republika Hrvatska	Croatia	Republic of Croatia	HR	—
Italia	Repubblica italiana	Italy	Italian Republic	IT	I
Κύπρος (*)	Κυπριακή Δημοκρατία	Cyprus	Republic of Cyprus	CY	—
Latvija	Latvijas Republika	Latvia	Republic of Latvia	LV	—
Lietuva	Lietuvos Respublika	Lithuania	Republic of Lithuania	LT	—
Luxembourg	Grand-Duché de Luxembourg	Luxembourg	Grand Duchy of Luxembourg	LU	L
Magyarország	Magyarország	Hungary	Hungary	HU	—
Malta	Repubblika ta' Malta	Malta	Republic of Malta	MT	—
Nederland	Koninkrijk der Nederlanden	Netherlands	Kingdom of the Netherlands	NL	NL
Österreich	Republik Österreich	Austria	Republic of Austria	AT	A
Polska	Rzeczpospolita Polska	Poland	Republic of Poland	PL	—
Portugal	República Portuguesa	Portugal	Portuguese Republic	PT	P
România	România	Romania	Romania	RO	—
Slovenija	Republika Slovenija	Slovenia	Republic of Slovenia	SI	—
Slovensko	Slovenská republika	Slovakia	Slovak Republic	SK	—
Suomi/Finland	Suomen tasavalta/ Republiken Finland	Finland	Republic of Finland	FI	FIN
Sverige	Konungariket Sverige	Sweden	Kingdom of Sweden	SE	S

(*) Latin transliteration: България = Bulgaria; Ελλάδα = Elláda; Κύπρος = Kýpros.

(1) The short name in the source language(s) is used to fix the protocol order and is used in multilingual documents (see Section 7.1.2).

(2) The abbreviation to use = ISO code, except for Greece, for which EL is recommended (instead of the ISO code GR). The former abbreviations (generally taken from the international code for automobiles) were used until the end of 2002.

Source: <https://publications.europa.eu/code/en/en-370100.htm>

The Geonomenclature is the country classification used for any trade in goods data transmitted to Eurostat. It is then necessary to ensure a conversion from the Geonomenclature to Eurostat's online database code list.

10.2. Conversion of codes

10.2.1. COUNTRY CODES

The Geonomenclature matches with Eurostat's online database code list except for the few codes listed below.

Geonomenclature			Eurostat's online database code list	
Code		Label	Code	Label
ALPHA-2	NUM			
CN	720	China	CN_X_HK	China except Hong Kong
CS	094	Serbia and Montenegro	RS_ME	Serbia and Montenegro
GB	006	United Kingdom	UK	United Kingdom
GR	009	Greece	EL	Greece
XC	021	Ceuta	ES630	Ceuta
XI	015	United Kingdom (Northern Ireland)	UKN	Northern Ireland (UK) (NUTS 2021)
XL	023	Melilla	ES640	Melilla
XS	098	Serbia	RS	Serbia

10.2.2. ECONOMIC ZONES

Geonomenclature		Eurostat's online database (data navigation tree) code list		
Code	Label	Code	Label	Descriptions
1000	World	WORLD	All countries of the world	
1010	European Union (evolutionary definition)	INT_EU	Intra-EU	
1011	Extra-European Union (evolutionary definition)	EXT_EU	Extra-EU	
1021	EFTA — <i>European Free Trade Association</i>	EFTA	European Free Trade Association	This aggregate covers following countries: CH, IS, LI, NO
1031	ACP — <i>African, Caribbean and Pacific countries</i>	ACP	African, Caribbean and Pacific Group of States, signatories of the Partnership Agreement	This aggregate covers following countries: AG,AO,BB,BF,BI,BJ,BS,BW,BZ,CD,CF,CG,CI,CK,CM,CU,CV,DJ,DM,DO,ER,ET,FJ,FM,GA,GD,GH,GM,GN,GQ,GW,GY,HT,IM,KE,KI,KM,KN,LC,LR,LS,MG,MH,ML,MR,MU,MW,MZ,NA,NE,NG,NR,NU,PG,PW,RW,SB,SC,SD,SL,SN,SO,SR,ST,SZ,TD,TG,TL,TO,TT,TV,TZ,UG,VC,VU,WS,ZA,ZM,ZW
1051	Mediterranean basin countries (excluding EU)	MED_X_HR	Mediterranean Basin Countries except Croatia	This aggregate covers following countries: AL, BA, DZ, EG, GI, IL, JO, LB, LY, MA, ME, MK, PS, RS, SY, TN, TR, XK
1053	OPEC — <i>Organisation of Petroleum Exporting Countries</i>	OPEC	Organization of Petroleum Exporting Countries (OPEC)	This aggregate covers following countries: IR (1960), IQ (1960), KW (1960), SA (1960), VE (1960), QA (1961), ID (1962 -Jan. 2009, reactivated Jan. 2016), LY (1962), AE (1967), DZ (1969), NG (1971), EC (1973 - suspended its membership from Dec. 1992 -Oct. 2007), AO (2007), GA (1975-1995), GQ (2017)
1057	ASEAN — <i>Association of South-East Asian Nations</i>	ASEAN	Association of Southeast Asian Nations	This aggregate covers following countries: BN, ID, KH, LA, MM, MY, PH, SG, TH, VN
1058	Latin American countries	AME_LAT	Latin American countries	
1120	WBCs — <i>Western Balkan Countries</i>	WBC	WBC - Western Balkan Countries (aggregate changing according to the context)	This aggregate covers following countries: AL, BA, ME, MK, XK, RS
1130	Candidate countries	CC8_22	Candidate countries from 2022 (8 countries)	This aggregate covers the Candidate Countries from 2022: BA, ME, MD, MK, AL, RS, TR, UA
1310	USMCA — <i>United States-Mexico-Canada Agreement</i>	USMCA	United States-Mexico-Canada Agreement (USMCA)	This aggregate covers following countries: CA, MX, US. USMCA replaced the North American Free Trade Agreement (NAFTA)
1415	DAEs — <i>Dynamic Asian economies</i>	DAE	Dynamic Asian economies (DAEs)	This aggregate covers following countries: HK, KR, MY, SG, TH, TW
1815	CIS — <i>Commonwealth of Independent States</i>	CIS	Commonwealth of Independent States (Former Soviet Union except BAL)	This aggregate covers following countries: AM, AZ, BY, KZ, KG, MD, RU, TJ, TM, UZ
2020	Euro area (20)	EA20	Euro area - 20 countries (from 2023)	This aggregate covers following countries since 2023: BE, DE, EE, IE, EL, ES, FR, HR, IT, CY, LV, LT, LU, MT, NL, AT, PT, SI, SK, FI
2027	European Union (27_2020)	EU27_2020	European Union - 27 countries (from 2020)	This aggregate covers following countries: BE, BG, CZ, DK, DE, EE, IE, EL, ES, FR, HR, IT, CY, LV, LT, LU, HU, MT, NL, AT, PL, PT, RO, SI, SK, FI, SE
2120	Extra-euro area (20)	EXT_EA20	Extra-euro area - 20 countries (from 2023)	
2127	Extra-European Union (27_2020)	EXT_EU27_2020	Extra-EU27 (from 2020)	
XE07	EU27 (2020) Member States not belonging to the Euro Area (from 2023): BG, CZ, DK, HU, PL, RO, SE	EU27_2020_NEA20	EU27 countries (from 2020) not in EA20 (from 2023) - 7 countries	This aggregate covers following countries: BG, CZ, DK, HU, PL, RO, SE

10.2.3. GEOGRAPHICAL ZONES

Geonomenclature		Eurostat's online database (data navigation tree) code list		
Code	Label	Code	Label	Descriptions
5000	World	WORLD	All countries of the world	
5110	European Union	EU27_2020	European Union - 27 countries (from 2020)	This aggregate covers following countries: BE, BG, CZ, DK, DE, EE, IE, EL, ES, FR, HR, IT, CY, LV, LT, LU, HU, MT, NL, AT, PL, PT, RO, SI, SK, FI, SE
5190	European countries excluding EU	'Aggregated data' datasets under the ' International trade in goods ' dedicated branch		
		EUR_NEU27_2020	European non-EU27 countries (from 2020)	
5190	European countries excluding EU	'Trade by enterprise characteristics' datasets under the ' International trade in goods ' dedicated branch		
		EUR_OTH	Other European countries (aggregate changing according to the context)	
5200	Africa	AFR	Africa	This aggregate covers following countries: BI, KM, DJ, ER, ET, KE, MG, MW, MU, YT, MZ, RE, RW, SC, SO, UG, TZ, ZM, ZW, AO, CM, CF, TD, CG, CD, GQ, GA, ST, DZ, EG, LY, MA, SD, TN, EH, BW, LS, NA, ZA, SZ, BJ, BF, CV, CI, GM, GH, GN, GW, LR, ML, MR, NE, NG, SH, SN, SL, TG
5210	North Africa	AFR_N	Northern Africa	This aggregate covers following countries: DZ, EG, LY, MA, SD, TN, EH
5290	Other African countries	AFR_OTH	Other African countries (aggregate changing according to the context)	
5300	America	AME	America	This aggregate covers following countries: AI, AG, AW, BS, BB, VG, KY, CU, DM, DO, GD, GP, HT, JM, MQ, MS, AN, PR, BL, KN, LC, MF, VC, TT, TC, VI, BZ, CR, SV, GT, HN, MX, NI, PA, AR, BO, BR, CL, CO, EC, FK, GF, GY, PY, PE, SR, UY, VE, BM, CA, GL, PM, US
5310	North America	AME_N	Northern America	This aggregate covers following countries: BM, CA, GL, PM, US
5320	Central America and Caribbean	AME_C_CRB	Central America and Caribbean	This aggregate covers following countries: AI, AG, AW, BS, BB, VG, KY, CU, DM, DO, GD, GP, HT, JM, MQ, MS, AN, PR, BL, KN, LC, MF, VC, TT, TC, VI, BZ, CR, SV, GT, HN, MX, NI, PA
5330	South America	AME_S	South America	This aggregate covers following countries: AR, BO, BR, CL, CO, EC, FK, GF, GY, PY, PE, SR, UY, VE
5400	Asia	ASI	Asia	This aggregate covers following countries: KZ, KG, TJ, TM, UZ, CN, HK, MO, KP, JP, MN, KR, AF, BD, BT, IN, IR, MV, NP, PK, LK, BN, KH, ID, LA, MY, MM, PH, SG, TH, TL, VN, AM, AZ, BH, GE, IQ, IL, JO, KW, LB, PS, OM, QA, SA, SY, TW, AE, YE

Geonomenclature		Eurostat's online database (data navigation tree) code list		
Code	Label	Code	Label	Descriptions
5410	Near and Middle Eastern countries	'Aggregated data' datasets under the ' International trade in goods ' dedicated branch		
		ASI_W_IR	Western Asia including Iran	This aggregate covers following countries: AE, AM, AZ, BH, GE, IL, IR, IQ, JO, KW, LB, OM, PS, QA, SA, SY, YE
5490	Other Asian countries	'Trade by enterprise characteristics' datasets under the ' International trade in goods ' dedicated branch		
		ASI_NME	Near and Middle East Asia (aggregate changing according to the context)	
5490	Other Asian countries	ASI_OTH	Other Asian countries (aggregate changing according to the context)	
5500	Oceania and Polar regions	OCE_PLR	Oceania and southern polar regions	This aggregate covers following countries: AU, NZ, NF, FJ, NC, PG, SB, VU, GU, KI, MH, FM, NR, MP, PW, AS, CK, PF, NU, PN, WS, TK, TO, TV, WF, AQ, BV, GS, TF
5910	Miscellaneous — Countries not specified intra	INT_EU_NAL	Intra-EU, not allocated	
5920	Miscellaneous — Countries not specified extra	EXT_EU_NAL	Extra-EU, not allocated	

11

Alphabetical index

A

<i>Abkhazia</i>	<i>Georgia</i>	<i>GE (076)</i>
<i>Abu Dhabi</i>	<i>United Arab Emirates</i>	<i>AE (647)</i>
<i>Adélie Land</i>	<i>Antarctica</i>	<i>AQ (891)</i>
<i>Adjaria</i>	<i>Georgia</i>	<i>GE (076)</i>
<i>Admiralty Islands</i>	<i>Papua New Guinea</i>	<i>PG (801)</i>
Afghanistan		AF (660)
<i>Africa South</i>	<i>South Africa</i>	<i>ZA (388)</i>
<i>Agalega, Islands</i>	<i>Mauritius</i>	<i>MU (373)</i>
<i>Ahvenanmaa, Islands</i>	<i>Finland</i>	<i>FI (032)</i>
<i>Ajman</i>	<i>United Arab Emirates</i>	<i>AE (647)</i>
<i>Åland, Islands</i>	<i>Finland</i>	<i>FI (032)</i>
<i>Alaska</i>	<i>United States</i>	<i>US (400)</i>
Albania		AL (070)
<i>Aldabra, Islands</i>	<i>Seychelles</i>	<i>SC (355)</i>
<i>Alderney, Island</i>	<i>United Kingdom</i>	<i>GB (006)</i>
Algeria		DZ (208)
<i>Alofi, Island</i>	<i>Wallis and Futuna</i>	<i>WF (811)</i>
<i>Alphonse, Island</i>	<i>Seychelles</i>	<i>SC (355)</i>
<i>Ambergris Cay, Island</i>	<i>Belize</i>	<i>BZ (421)</i>
American Samoa		AS (830)
<i>Amindivi, Islands</i>	<i>India</i>	<i>IN (664)</i>
<i>Amirantes, Islands</i>	<i>Seychelles</i>	<i>SC (355)</i>
<i>Amsterdam, Island</i>	<i>French Southern Territories</i>	<i>TF (894)</i>
<i>Andaman, Islands</i>	<i>India</i>	<i>IN (664)</i>
Andorra		AD (043)
<i>Andros, Island</i>	<i>Bahamas</i>	<i>BS (453)</i>
<i>Anegada</i>	<i>Virgin Islands, British</i>	<i>VG (468)</i>
Angola		AO (330)
Anguilla		AI (446)
<i>Anjouan, Island</i>	<i>Comoros</i>	<i>KM (375)</i>
<i>Annobón, Island</i>	<i>Equatorial Guinea</i>	<i>GQ (310)</i>
<i>Antarctic, Australian Territory</i>	<i>Antarctica</i>	<i>AQ (891)</i>
<i>Antarctic, British Territory</i>	<i>Antarctica</i>	<i>AQ (891)</i>
<i>Antarctica, Peninsula</i>	<i>Antarctica</i>	<i>AQ (891)</i>
Antarctica		AQ (891)
Antigua and Barbuda		AG (459)
<i>Antipodes, Islands</i>	<i>New Zealand</i>	<i>NZ (804)</i>
<i>Apolima, Island</i>	<i>Samoa</i>	<i>WS (819)</i>
<i>Arab, United - Emirates</i>	<i>United Arab Emirates</i>	<i>AE (647)</i>
<i>Archipelago des Bijagos</i>	<i>Guinea-Bissau</i>	<i>GW (257)</i>
<i>Archipelago Franz Joseph</i>	<i>Russian Federation</i>	<i>RU (075)</i>
<i>Archipelago, Bismarck</i>	<i>Papua New Guinea</i>	<i>PG (801)</i>
<i>Archipelago, Canadian Arctic</i>	<i>Canada</i>	<i>CA (404)</i>
<i>Archipelago, Chagos</i>	<i>British Indian Ocean Territory</i>	<i>IO (357)</i>
<i>Archipelago, Svalbard</i>	<i>Norway</i>	<i>NO (028)</i>
<i>Archipelago, Tuamotu</i>	<i>French Polynesia</i>	<i>PF (822)</i>
<i>Archipelago, Visayas</i>	<i>Philippines</i>	<i>PH (708)</i>

<i>Arctic archipelago, Canadian</i>	<i>Canada</i>	CA (404)
Argentina		AR (528)
<i>Aride, Island</i>	<i>Seychelles</i>	SC (355)
Armenia		AM (077)
Aruba		AW (474)
<i>Ascension, Island</i>	<i>Saint Helena, Ascension and Tristan da Cunha</i>	SH (329)
<i>Astove, Island</i>	<i>Seychelles</i>	SC (355)
<i>Auckland, Islands</i>	<i>New Zealand</i>	NZ (804)
<i>Aunu'u, Island</i>	<i>American Samoa</i>	AS (830)
<i>Aurigny, Island</i>	<i>United Kingdom</i>	GB (006)
Australia		AU (800)
<i>Australian Antarctic Territory</i>	<i>Antarctica</i>	AQ (891)
Austria		AT (038)
<i>Aves, Island</i>	<i>Venezuela, Bolivarian Republic of</i>	VE (484)
<i>Axel Heiberg, Island</i>	<i>Canada</i>	CA (404)
Azerbaijan		AZ (078)
<i>Azores, Archipelago of the</i>	<i>Portugal</i>	PT (010)
B		
<i>Babelthuap, Island</i>	<i>Palau</i>	PW (825)
<i>Baffin, Island</i>	<i>Canada</i>	CA (404)
Bahamas		BS (453)
<i>Bahia, Islands</i>	<i>Honduras</i>	HN (424)
Bahrain		BH (640)
<i>Baker, Island</i>	<i>United States Minor Outlying Islands</i>	UM (832)
<i>Balearic Islands</i>	<i>Spain</i>	ES (011)
<i>Bali, Island</i>	<i>Indonesia</i>	ID (700)
<i>Banaba, Island</i>	<i>Kiribati</i>	KI (812)
Bangladesh		BD (666)
<i>Banks, Island</i>	<i>Canada</i>	CA (404)
Barbados		BB (469)
<i>Barbuda, Island</i>	<i>Antigua and Barbuda</i>	AG (459)
<i>Barents, Island</i>	<i>Norway</i>	NO (028)
<i>Bear, Island</i>	<i>Norway</i>	NO (028)
Belarus		BY (073)
<i>Belep, Islands</i>	<i>New Caledonia</i>	NC (809)
Belgium		BE (017)
Belize		BZ (421)
<i>Belorussia</i>	<i>Belarus</i>	BY (073)
Benin		BJ (284)
<i>Bequia, Island</i>	<i>St Vincent and the Grenadines</i>	VC (467)
Bermuda		BM (413)
Bhutan		BT (675)
<i>Bijagos archipelago</i>	<i>Guinea-Bissau</i>	GW (257)
<i>Bimini, Island</i>	<i>Bahamas</i>	BS (453)
<i>Bioko, Island</i>	<i>Equatorial Guinea</i>	GQ (310)
<i>Bird, Island</i>	<i>Seychelles</i>	SC (355)
<i>Bismarck archipelago</i>	<i>Papua New Guinea</i>	PG (801)
<i>Boa Vista, Island</i>	<i>Cabo Verde</i>	CV (247)
<i>Boaz, Island</i>	<i>Bermuda</i>	BM (413)
Bolivia, Plurinational State of		BO (516)
<i>Bonaire, Island</i>	<i>Bonaire, Sint Eustatius and Saba</i>	BQ (477)
Bonaire, Sint Eustatius and Saba		BQ (477)
<i>Borneo, Island</i>	<i>Brunei Darussalam</i>	BN (703)
<i>Borneo, Island</i>	<i>Indonesia</i>	ID (700)
<i>Bornholm, Island</i>	<i>Denmark</i>	DK (008)
Bosnia and Herzegovina		BA (093)
Botswana		BW (391)
<i>Boûbiyan, Island</i>	<i>Kuwait</i>	KW (636)
<i>Bougainville, Island</i>	<i>Papua New Guinea</i>	PG (801)
<i>Bounty, Islands</i>	<i>New Zealand</i>	NZ (804)
Bouvet Island		BV (892)
<i>Branco, Island</i>	<i>Cabo Verde</i>	CV (247)

<i>Brava, Island</i>	<i>Cabo Verde</i>	CV (247)
Brazil		BR (508)
<i>British Antarctic Territory</i>	<i>Antarctica</i>	AQ (891)
<i>British Channel Islands</i>	<i>United Kingdom</i>	GB (006)
<i>British Guiana</i>	<i>Guyana</i>	GY (488)
British Indian Ocean Territory		IO (357)
Brunei Darussalam		BN (703)
<i>Buka, Island</i>	<i>Papua New Guinea</i>	PG (801)
Bulgaria		BG (068)
Burkina Faso		BF (236)
<i>Burma</i>	<i>Myanmar</i>	MM (676)
Burundi		BI (328)
<i>Büsingen, Territory of</i>	<i>Switzerland</i>	CH (039)
C		
<i>Cabinda, Enclave of</i>	<i>Angola</i>	AO (330)
Cabo Verde		CV (247)
<i>Caicos, Islands</i>	<i>Turks and Caicos Islands</i>	TC (454)
<i>Camagüey, Archipelago</i>	<i>Cuba</i>	CU (448)
Cambodia		KH (696)
Cameroon		CM (302)
<i>Campbell, Island</i>	<i>New Zealand</i>	NZ (804)
<i>Campione d'Italia, the Italian municipality of</i>	<i>Italy</i>	IT (005)
Canada		CA (404)
<i>Canadian Arctic Archipelago</i>	<i>Canada</i>	CA (404)
<i>Canal Zone, The former</i>	<i>Panama</i>	PA (442)
<i>Canary Islands</i>	<i>Spain</i>	ES (011)
<i>Canouan, Island</i>	<i>St Vincent and the Grenadines</i>	VC (467)
<i>Cape Verde</i>	<i>Cabo Verde</i>	CV (247)
<i>Cargados Carajos Shoals, Islands</i>	<i>Mauritius</i>	MU (373)
<i>Caroline, Island</i>	<i>Micronesia, Federated States of</i>	FM (823)
<i>Carriacou, Island</i>	<i>Grenada</i>	GD (473)
<i>Cayman Brac, Island</i>	<i>Cayman Islands</i>	KY (463)
Cayman Islands		KY (463)
<i>Celebes, Island</i>	<i>Indonesia</i>	ID (700)
Central African Republic		CF (306)
<i>Cerf, Island</i>	<i>Seychelles</i>	SC (355)
Ceuta		XC (021)
<i>Ceylon</i>	<i>Sri Lanka</i>	LK (669)
Chad		TD (244)
<i>Chafarinas Islands</i>	<i>Melilla</i>	XL (023)
<i>Chagos archipelago</i>	<i>British Indian Ocean Territory</i>	IO (357)
<i>Channel Islands, British</i>	<i>United Kingdom</i>	GB (006)
<i>Chatham, Islands</i>	<i>New Zealand</i>	NZ (804)
<i>Cheju, Island</i>	<i>Korea, Republic of</i>	KR (728)
<i>Chesterfield, Islands</i>	<i>New Caledonia</i>	NC (809)
Chile		CL (512)
<i>Chiloé, Island</i>	<i>Chile</i>	CL (512)
China		CN (720)
<i>Chonos archipelago</i>	<i>Chile</i>	CL (512)
Christmas Island		CX (834)
<i>Chuuk</i>	<i>Micronesia, Federated States of</i>	FM (823)
<i>Clipperton, Island</i>	<i>French Polynesia</i>	PF (822)
<i>Coco, Island</i>	<i>Costa Rica</i>	CR (436)
Cocos (Keeling), Islands		CC (833)
<i>Coëtivy, Island</i>	<i>Seychelles</i>	SC (355)
<i>Coiba, Island</i>	<i>Panama</i>	PA (442)
Colombia		CO (480)
<i>Comino, Island</i>	<i>Malta</i>	MT (046)
<i>Cominotto, Island</i>	<i>Malta</i>	MT (046)
Comoros		KM (375)
<i>Conakry</i>	<i>Guinea</i>	GN (260)
Congo, Democratic Republic of		CD (322)
Congo		CG (318)

Cook Islands		CK (837)
<i>Corisco, Island</i>	<i>Equatorial Guinea</i>	GQ (310)
<i>Corn, Islands</i>	<i>Nicaragua</i>	NI (432)
<i>Coronation, Island</i>	<i>Antarctica</i>	AQ (891)
<i>Corsica</i>	<i>France</i>	FR (001)
<i>Corvo, Island</i>	<i>Portugal</i>	PT (010)
<i>Cosmoledo, Islands</i>	<i>Seychelles</i>	SC (355)
Costa Rica		CR (436)
Côte d'Ivoire		CI (272)
Croatia		HR (092)
<i>Crozét, archipelago</i>	<i>French Southern Territories</i>	TF (894)
Cuba		CU (448)
<i>Culebra, Island</i>	<i>United States</i>	US (400)
Curaçao		CW (475)
<i>Curieuse, Island</i>	<i>Seychelles</i>	SC (355)
Cyprus		CY (600)
<i>Czech Republic</i>	<i>Czechia</i>	CZ (061)
Czechia		CZ (061)
D		
<i>Dahlak, archipelago</i>	<i>Eritrea</i>	ER (336)
<i>Deception, Island</i>	<i>Antarctica</i>	AQ (891)
<i>Democratic Republic of the Congo</i>	<i>Congo, Democratic Republic of</i>	CD (322)
<i>Denis, Island</i>	<i>Seychelles</i>	SC (355)
Denmark		DK (008)
<i>Dependencies of New Caledonia</i>	<i>New Caledonia</i>	NC (809)
<i>Dependencies of Seychelles</i>	<i>Seychelles</i>	SC (355)
<i>Dependencies of St Helena</i>	<i>Saint Helena, Ascension and Tristan da Cunha</i>	SH (329)
<i>Dependency, Ross</i>	<i>Antarctica</i>	AQ (891)
<i>Desroches, Islands</i>	<i>Seychelles</i>	SC (355)
<i>Devon, Island</i>	<i>Canada</i>	CA (404)
<i>Djerba, Island</i>	<i>Tunisia</i>	TN (212)
Djibouti		DJ (338)
Dominica		DM (460)
Dominican Republic		DO (456)
<i>Dubai</i>	<i>United Arab Emirates</i>	AE (647)
<i>Ducie, Island</i>	<i>Pitcairn</i>	PN (813)
<i>Duke of York Islands</i>	<i>Papua New Guinea</i>	PG (801)
<i>Dutch Guiana</i>	<i>Suriname</i>	SR (492)
E		
<i>East Jerusalem</i>	<i>Palestinian Territory, Occupied</i>	PS (625)
<i>Easter Island</i>	<i>Chile</i>	CL (512)
Ecuador		EC (500)
<i>Edge, Island</i>	<i>Norway</i>	NO (028)
<i>Efate, Island</i>	<i>Vanuatu</i>	VU (816)
Egypt		EG (220)
<i>Eire</i>	<i>Ireland</i>	IE (007)
<i>El Rey, Island</i>	<i>Panama</i>	PA (442)
El Salvador		SV (428)
<i>Elba, Island</i>	<i>Italy</i>	IT (005)
<i>Elephant, Island</i>	<i>Antarctica</i>	AQ (891)
<i>Eleuthera, Island</i>	<i>Bahamas</i>	BS (453)
<i>Ellesmere, Island</i>	<i>Canada</i>	CA (404)
<i>Elobays, Islands</i>	<i>Equatorial Guinea</i>	GQ (310)
<i>Emirates, United Arab</i>	<i>United Arab Emirates</i>	AE (647)
<i>Entrecasteaux, Islands</i>	<i>Papua New Guinea</i>	PG (801)
Equatorial Guinea		GQ (310)
Eritrea		ER (336)
Estonia		EE (053)
Eswatini		SZ (393)
Ethiopia		ET (334)
<i>Eua, Island</i>	<i>Tonga</i>	TO (817)

F		
<i>Faial, Island</i>	<i>Portugal</i>	PT (010)
<i>Faiġakah, Island</i>	<i>Kuwait</i>	KW (636)
Falkland Islands		FK (529)
<i>Falster, Island</i>	<i>Denmark</i>	DK (008)
Faroe Islands		FO (041)
<i>Farquhar, Islands</i>	<i>Seychelles</i>	SC (355)
<i>Federated States of Micronesia</i>	<i>Micronesia, Federated States of</i>	FM (823)
<i>Federation, Russian</i>	<i>Russian Federation</i>	RU (075)
<i>Félicité, Island</i>	<i>Seychelles</i>	SC (355)
<i>Fernando de Noronha, Island</i>	<i>Brazil</i>	BR (508)
<i>Fernando Póo, Island</i>	<i>Equatorial Guinea</i>	GQ (310)
Fiji		FJ (815)
<i>Filfola, Island</i>	<i>Malta</i>	MT (046)
Finland		FI (032)
<i>Flores, Island</i>	<i>Indonesia</i>	ID (700)
<i>Flores, Island</i>	<i>Portugal</i>	PT (010)
<i>Fogo, Island</i>	<i>Cabo Verde</i>	CV (247)
<i>Fongafale</i>	<i>Tuvalu</i>	TV (807)
<i>Formentera, Island</i>	<i>Spain</i>	ES (011)
<i>Former Yugoslav Republic of Macedonia</i>	<i>North Macedonia</i>	MK (096)
<i>Formosa</i>	<i>Taiwan</i>	TW (736)
France		FR (001)
<i>Franz Josef Land</i>	<i>Russian Federation</i>	RU (075)
<i>Frégate, Island</i>	<i>Seychelles</i>	SC (355)
<i>French Guiana</i>	<i>France</i>	FR (001)
French Polynesia		PF (822)
French Southern Territories		TF (894)
<i>Fuego, Tierra del</i>	<i>Argentina</i>	AR (528)
<i>Fuego, Tierra del</i>	<i>Chile</i>	CL (512)
<i>Fuerteventura, Island</i>	<i>Spain</i>	ES (011)
<i>Fujairah</i>	<i>United Arab Emirates</i>	AE (647)
<i>Funafuti, Atoll</i>	<i>Tuvalu</i>	TV (807)
<i>Funen, Island</i>	<i>Denmark</i>	DK (008)
<i>Futuna, Island</i>	<i>Wallis and Futuna</i>	WF (811)
G		
Gabon		GA (314)
<i>Galapagos, Islands</i>	<i>Ecuador</i>	EC (500)
Gambia		GM (252)
<i>Gambier, Islands</i>	<i>French Polynesia</i>	PF (822)
<i>Gaza Strip</i>	<i>Palestinian Territory, Occupied</i>	PS (625)
Georgia		GE (076)
<i>German Territory of Büsingen</i>	<i>Switzerland</i>	CH (039)
Germany		DE (004)
Ghana		GH (276)
Gibraltar		GI (044)
<i>Gilbert, Islands</i>	<i>Kiribati</i>	KI (812)
<i>Gomera, Island</i>	<i>Spain</i>	ES (011)
<i>Gonâve, Island</i>	<i>Haiti</i>	HT (452)
<i>Gorée, Island</i>	<i>Senegal</i>	SN (248)
<i>Gotland, Island</i>	<i>Sweden</i>	SE (030)
<i>Gough, Island</i>	<i>Saint Helena, Ascension and Tristan da Cunha</i>	SH (329)
<i>Gozo, Island</i>	<i>Malta</i>	MT (046)
<i>Graciosa, Island</i>	<i>Portugal</i>	PT (010)
<i>Gran Canaria, Island</i>	<i>Spain</i>	ES (011)
<i>Grand Bahama, Island</i>	<i>Bahamas</i>	BS (453)
<i>Grand Cayman, Island</i>	<i>Cayman Islands</i>	KY (463)
<i>Grand Turk, Island</i>	<i>Turks and Caicos Islands</i>	TC (454)
<i>Grande Cayemite, Island</i>	<i>Haiti</i>	HT (452)
<i>Grande Comore, Island</i>	<i>Comoros</i>	KM (375)
<i>Grande-Terre</i>	<i>France</i>	FR (001)

<i>Great Abaco, Island</i>	<i>Bahamas</i>	BS (453)
<i>Great Bermuda, Island</i>	<i>Bermuda</i>	BM (413)
<i>Great Britain</i>	<i>United Kingdom</i>	GB (006)
<i>Great Inagua, Island</i>	<i>Bahamas</i>	BS (453)
Greece		GR (009)
<i>Green, Islands</i>	<i>Papua New Guinea</i>	PG (801)
Greenland		GL (406)
Grenada		GD (473)
<i>Guadeloupe, Island</i>	<i>France</i>	FR (001)
Guam		GU (831)
Guatemala		GT (416)
<i>Guernsey, Island</i>	<i>United Kingdom</i>	GB (006)
<i>Guiana, French</i>	<i>France</i>	FR (001)
Guinea		GN (260)
Guinea-Bissau		GW (257)
Guyana		GY (488)
H		
<i>Ha'apai, Islands</i>	<i>Tonga</i>	TO (817)
Haiti		HT (452)
<i>Harbour, Island</i>	<i>Bahamas</i>	BS (453)
<i>Hawaiian, Islands</i>	<i>United States</i>	US (400)
Heard Island and McDonald Islands		HM (835)
<i>Heard, Island</i>	<i>Heard Island and McDonald Islands</i>	HM (835)
<i>Heligoland, Island</i>	<i>Germany</i>	DE (004)
<i>Henderson, Island</i>	<i>Pitcairn</i>	PN (813)
<i>Herzegovina, Bosnia and</i>	<i>Bosnia and Herzegovina</i>	BA (093)
<i>Hierro, Island</i>	<i>Spain</i>	ES (011)
<i>Hiiumaa, Island</i>	<i>Estonia</i>	EE (053)
<i>Hispaniola</i>	<i>Haiti</i>	HT (452)
<i>Hokkaido, Island</i>	<i>Japan</i>	JP (732)
Holy See		VA (045)
Honduras		HN (424)
Hong Kong		HK (740)
<i>Honshu, Island</i>	<i>Japan</i>	JP (732)
<i>Hooru, Islands</i>	<i>Wallis and Futuna</i>	WF (811)
<i>Horn, Islands</i>	<i>Wallis and Futuna</i>	WF (811)
<i>Howland, Island</i>	<i>United States Minor Outlying Islands</i>	UM (832)
Hungary		HU (064)
<i>Huon, Island</i>	<i>New Caledonia</i>	NC (809)
I		
<i>Ibiza</i>	<i>Spain</i>	ES (011)
Iceland		IS (024)
<i>Île à Vache</i>	<i>Haiti</i>	HT (452)
<i>Inaccessible, Island</i>	<i>Saint Helena, Ascension and Tristan da Cunha</i>	SH (329)
India		IN (664)
<i>Indian Ocean Territory, British</i>	<i>British Indian Ocean Territory</i>	IO (357)
Indonesia		ID (700)
Iran, Islamic Republic of		IR (616)
Iraq		IQ (612)
<i>Ireland, Island</i>	<i>Bermuda</i>	BM (413)
Ireland		IE (007)
<i>Irian Jaya, Island</i>	<i>Indonesia</i>	ID (700)
<i>Isabela, Island</i>	<i>Ecuador</i>	EC (500)
<i>Isle of Man</i>	<i>United Kingdom</i>	GB (006)
Israel		IL (624)
<i>Italian municipality of Campione d'Italia</i>	<i>Italy</i>	IT (005)
Italy		IT (005)
<i>Ivory Coast</i>	<i>Côte d'Ivoire</i>	CI (272)

J		
Jamaica		JM (464)
<i>Jan Mayen, Island</i>	<i>Norway</i>	<i>NO (028)</i>
Japan		JP (732)
<i>Jarvis, Island</i>	<i>United States Minor Outlying Islands</i>	<i>UM (832)</i>
<i>Java, Island</i>	<i>Indonesia</i>	<i>ID (700)</i>
<i>Jersey, Island</i>	<i>United Kingdom</i>	<i>GB (006)</i>
<i>Johnston, Atoll</i>	<i>United States Minor Outlying Islands</i>	<i>UM (832)</i>
Jordan		JO (628)
<i>Jost Van Dyke</i>	<i>Virgin Islands, British</i>	<i>VG (468)</i>
<i>Juan Fernandes, Islands</i>	<i>Chile</i>	<i>CL (512)</i>
<i>Juventud, Island</i>	<i>Cuba</i>	<i>CU (448)</i>
K		
<i>Kalimantal, Island</i>	<i>Indonesia</i>	<i>ID (700)</i>
<i>Kaliningrad, Enclave of</i>	<i>Russian Federation</i>	<i>RU (075)</i>
<i>Kamaran, Island</i>	<i>Yemen</i>	<i>YE (653)</i>
Kazakhstan		KZ (079)
<i>Keeling, Islands</i>	<i>Cocos (Keeling), Islands</i>	<i>CC (833)</i>
Kenya		KE (346)
<i>Kerguelen, Islands</i>	<i>French Southern Territories</i>	<i>TF (894)</i>
<i>Kermadec, Island</i>	<i>New Zealand</i>	<i>NZ (804)</i>
<i>King Charles, Land</i>	<i>Norway</i>	<i>NO (028)</i>
<i>King George, Island</i>	<i>Antarctica</i>	<i>AQ (891)</i>
<i>Kingman Reef</i>	<i>United States Minor Outlying Islands</i>	<i>UM (832)</i>
<i>Kinmen</i>	<i>Taiwan</i>	<i>TW (736)</i>
Kiribati		KI (812)
Korea, Democratic People's Republic of		KP (724)
Korea, Republic of		KR (728)
<i>Korea, South</i>	<i>Korea, Republic of</i>	<i>KR (728)</i>
<i>Koror, Island</i>	<i>Palau</i>	<i>PW (825)</i>
Kosovo		XK (095)
<i>Kosrae</i>	<i>Micronesia, Federated States of</i>	<i>FM (823)</i>
<i>Kowloon</i>	<i>Hong Kong</i>	<i>HK (740)</i>
<i>Kuril, Islands</i>	<i>Russian Federation</i>	<i>RU (075)</i>
Kuwait		KW (636)
<i>Kyrgyz Republic</i>	<i>Kyrgyzstan</i>	<i>KG (083)</i>
Kyrgyzstan		KG (083)
<i>Kyushu</i>	<i>Japan</i>	<i>JP (732)</i>
L		
<i>La Digue, Island</i>	<i>Seychelles</i>	<i>SC (355)</i>
<i>La Palma, Island</i>	<i>Spain</i>	<i>ES (011)</i>
<i>Labuan</i>	<i>Malaysia</i>	<i>MY (701)</i>
<i>Laccadive, Island</i>	<i>India</i>	<i>IN (664)</i>
<i>Langeland, Island</i>	<i>Denmark</i>	<i>DK (008)</i>
<i>Lantau, Island</i>	<i>Hong Kong</i>	<i>HK (740)</i>
<i>Lanzarote, Island</i>	<i>Spain</i>	<i>ES (011)</i>
Lao People's Democratic Republic		LA (684)
<i>Laos</i>	<i>Lao People's Democratic Republic</i>	<i>LA (684)</i>
<i>Las Perlas archipelago</i>	<i>Panama</i>	<i>PA (442)</i>
Latvia		LV (054)
<i>Laurie, Island</i>	<i>Antarctica</i>	<i>AQ (891)</i>
<i>Lavongai</i>	<i>Papua New Guinea</i>	<i>PG (801)</i>
Lebanon		LB (604)
<i>Leeward, Islands</i>	<i>French Polynesia</i>	<i>PF (822)</i>
<i>Leeward, Islands</i>	<i>Montserrat</i>	<i>MS (470)</i>
<i>Leeward, Netherlands Islands</i>	<i>Bonaire, Sint Eustatius and Saba</i>	<i>BQ (477)</i>
<i>Leeward, Netherlands Islands</i>	<i>Curaçao</i>	<i>CW (475)</i>
Lesotho		LS (395)
Liberia		LR (268)
Libya		LY (216)
<i>Libyan Arab Jamahiriya</i>	<i>Libya</i>	<i>LY (216)</i>

Liechtenstein		LI (037)
<i>Lifou, Island</i>	<i>New Caledonia</i>	NC (809)
<i>Ligne, Islands</i>	<i>Kiribati</i>	KI (812)
Lithuania		LT (055)
<i>Little Cayman, Island</i>	<i>Cayman Islands</i>	KY (463)
<i>Livigno</i>	<i>Italy</i>	IT (005)
<i>Lolland, Island</i>	<i>Denmark</i>	DK (008)
<i>Long, Island</i>	<i>Bahamas</i>	BS (453)
<i>Los Canarreosa, Archipelago</i>	<i>Cuba</i>	CU (448)
<i>Los Colorados, Archipelago</i>	<i>Cuba</i>	CU (448)
<i>Los Islands</i>	<i>Guinea</i>	GN (260)
<i>Los Jardines de la Reina, Archipelago</i>	<i>Cuba</i>	CU (448)
<i>Louisiade archipelago</i>	<i>Papua New Guinea</i>	PG (801)
<i>Loyalty, Islands</i>	<i>New Caledonia</i>	NC (809)
Luxembourg		LU (018)
<i>Luzon, Island</i>	<i>Philippines</i>	PH (708)
M		
Macao		MO (743)
<i>Macedonia, Former Yugoslav Republic of</i>	<i>North Macedonia</i>	MK (096)
Madagascar		MG (370)
<i>Madeira, Archipelago of</i>	<i>Portugal</i>	PT (010)
<i>Mafia, Island</i>	<i>Tanzania, United Republic of</i>	TZ (352)
<i>Mahé, Island</i>	<i>Seychelles</i>	SC (355)
<i>Mahoré</i>	<i>France</i>	FR (001)
<i>Main Island</i>	<i>Bermuda</i>	BM (413)
<i>Maio, Island</i>	<i>Cabo Verde</i>	CV (247)
<i>Majorca</i>	<i>Spain</i>	ES (011)
Malawi		MW (386)
Malaysia		MY (701)
Maldives		MV (667)
<i>Malekula, Island</i>	<i>Vanuatu</i>	VU (816)
Mali		ML (232)
<i>Malpelo, Island</i>	<i>Colombia</i>	CO (480)
Malta		MT (046)
<i>Malvinas, Islands</i>	<i>Falkland Islands</i>	FK (529)
<i>Mamelles, Islands</i>	<i>Seychelles</i>	SC (355)
<i>Man, Isle of</i>	<i>United Kingdom</i>	GB (006)
<i>Mangareva, Island</i>	<i>French Polynesia</i>	PF (822)
<i>Manono, Island</i>	<i>Samoa</i>	WS (819)
<i>Maoré</i>	<i>France</i>	FR (001)
<i>Maré, Island</i>	<i>New Caledonia</i>	NC (809)
<i>Margarita, Island</i>	<i>Venezuela, Bolivarian Republic of</i>	VE (484)
<i>Marion, Island</i>	<i>South Africa</i>	ZA (388)
<i>Marquesas, Island</i>	<i>French Polynesia</i>	PF (822)
Marshall Islands		MH (824)
<i>Martim Vaz, Island</i>	<i>Brazil</i>	BR (508)
<i>Martinique, Island</i>	<i>France</i>	FR (001)
<i>Matsu, Islands</i>	<i>Taiwan</i>	TW (736)
<i>Maud, Queen - Land</i>	<i>Antarctica</i>	AQ (891)
Mauritania		MR (228)
Mauritius		MU (373)
<i>Mayaguana, Island</i>	<i>Bahamas</i>	BS (453)
<i>Mayen, Jan - Island</i>	<i>Norway</i>	NO (028)
<i>Mayotte</i>	<i>France</i>	FR (001)
<i>Mayreau, Island</i>	<i>St Vincent and the Grenadines</i>	VC (467)
<i>Mbini</i>	<i>Equatorial Guinea</i>	GQ (310)
<i>McDonald, Island</i>	<i>Heard Island and McDonald Islands</i>	HM (835)
Melilla		XL (023)
<i>Melville, Island</i>	<i>Canada</i>	CA (404)
Mexico		MX (412)
Micronesia, Federated States of		FM (823)
<i>Midway, Island</i>	<i>United States Minor Outlying Islands</i>	UM (832)
<i>Mindanao, Island</i>	<i>Philippines</i>	PH (708)

<i>Mindoro, Island</i>	<i>Philippines</i>	PH (708)
<i>Minicoy, Island</i>	<i>India</i>	IN (664)
<i>Minorca</i>	<i>Spain</i>	ES (011)
<i>Miquelon, Island</i>	<i>Saint Pierre and Miquelon</i>	PM (408)
<i>Mohéli</i>	<i>Comoros</i>	KM (375)
<i>Moili, Island</i>	<i>Comoros</i>	KM (375)
<i>Moldavia</i>	<i>Moldova, Republic of</i>	MD (074)
Moldova, Republic of		MD (074)
<i>Moluccan, Islands</i>	<i>Indonesia</i>	ID (700)
<i>Møn, Island</i>	<i>Denmark</i>	DK (008)
<i>Mona, Island</i>	<i>United States</i>	US (400)
<i>Monaco</i>	<i>France</i>	FR (001)
Mongolia		MN (716)
Montenegro		ME (097)
Montserrat		MS (470)
Morocco		MA (204)
<i>Mouharraq, Island</i>	<i>Bahrain</i>	BH (640)
<i>Moussandam peninsula</i>	<i>Oman</i>	OM (649)
Mozambique		MZ (366)
<i>Municipality, The Italian - of Campione d'Italia</i>	<i>Italy</i>	IT (005)
<i>Mustique, Island</i>	<i>St Vincent and the Grenadines</i>	VC (467)
<i>Mwali</i>	<i>Comoros</i>	KM (375)
Myanmar		MM (676)
N		
<i>Nagorno-Karabakh</i>	<i>Azerbaijan</i>	AZ (078)
<i>Nakhichevan</i>	<i>Azerbaijan</i>	AZ (078)
Namibia		NA (389)
Nauru		NR (803)
<i>Navassa, Island</i>	<i>United States Minor Outlying Islands</i>	UM (832)
<i>Ndzouani, Island</i>	<i>Comoros</i>	KM (375)
<i>Negara Brunei Darussalam</i>	<i>Brunei Darussalam</i>	BN (703)
Nepal		NP (672)
<i>Netherlands Antilles</i>	<i>Bonaire, Sint Eustatius and Saba</i>	BQ (477)
<i>Netherlands Antilles</i>	<i>Curaçao</i>	CW (475)
<i>Netherlands Antilles</i>	<i>Sint Maarten (Dutch part)</i>	SX (479)
Netherlands		NL (003)
<i>Nevis</i>	<i>St Kitts and Nevis</i>	KN (449)
<i>New Amsterdam, Island</i>	<i>French Southern Territories</i>	TF (894)
<i>New Britain</i>	<i>Papua New Guinea</i>	PG (801)
New Caledonia		NC (809)
<i>New Guinea, Papua</i>	<i>Papua New Guinea</i>	PG (801)
<i>New Hanover</i>	<i>Papua New Guinea</i>	PG (801)
<i>New Ireland</i>	<i>Papua New Guinea</i>	PG (801)
<i>New Providence, Island</i>	<i>Bahamas</i>	BS (453)
<i>New Siberian Islands</i>	<i>Russian Federation</i>	RU (075)
<i>New Territories</i>	<i>Hong Kong</i>	HK (740)
New Zealand		NZ (804)
<i>Ngazidja</i>	<i>Comoros</i>	KM (375)
<i>Ngwane</i>	<i>Eswatini</i>	SZ (393)
Nicaragua		NI (432)
<i>Nicobar, Islands</i>	<i>India</i>	IN (664)
Niger		NE (240)
Nigeria		NG (288)
<i>Nightingale, Island</i>	<i>Saint Helena, Ascension and Tristan da Cunha</i>	SH (329)
<i>Niuas, Island</i>	<i>Tonga</i>	TO (817)
Niue		NU (838)
<i>Nord, Island</i>	<i>Seychelles</i>	SC (355)
Norfolk Island		NF (836)
<i>North Korea</i>	<i>Korea, Democratic People's Republic of</i>	KP (724)
North Macedonia		MK (096)
<i>North Yemen</i>	<i>Yemen</i>	YE (653)
<i>North-East Land</i>	<i>Norway</i>	NO (028)

<i>Northern Grenadine Islands</i>	<i>St Vincent and the Grenadines</i>	VC (467)
<i>Northern Ireland</i>	<i>United Kingdom</i>	GB (006)
Northern Mariana Islands		MP (820)
<i>Northern Solomon Islands</i>	<i>Papua New Guinea</i>	PG (801)
Norway		NO (028)
<i>Nosy-Be, Island</i>	<i>Madagascar</i>	MG (370)
<i>Novaya Zemlya</i>	<i>Russian Federation</i>	RU (075)
<i>Nzwani</i>	<i>Comoros</i>	KM (375)
O		
<i>Occupied Palestinian Territory</i>	<i>Palestinian Territory, Occupied</i>	PS (625)
<i>Ocean, Island</i>	<i>Kiribati</i>	KI (812)
<i>Oeno, Island</i>	<i>Pitcairn</i>	PN (813)
<i>Ofu, Island</i>	<i>American Samoa</i>	AS (830)
<i>Oil Islands</i>	<i>British Indian Ocean Territory</i>	IO (357)
<i>Öland, Island</i>	<i>Sweden</i>	SE (030)
<i>Olosega, Island</i>	<i>American Samoa</i>	AS (830)
Oman		OM (649)
<i>Ouvéa, Island</i>	<i>New Caledonia</i>	NC (809)
P		
<i>Pagalu, Islet</i>	<i>Equatorial Guinea</i>	GQ (310)
Pakistan		PK (662)
<i>Palaos</i>	<i>Palau</i>	PW (825)
Palau		PW (825)
<i>Palawan, Island</i>	<i>Philippines</i>	PH (708)
Palestinian Territory, Occupied		PS (625)
<i>Palmyra, Atoll</i>	<i>United States Minor Outlying Islands</i>	UM (832)
<i>Pamandzi</i>	<i>France</i>	FR (001)
Panama		PA (442)
Papua New Guinea		PG (801)
Paraguay		PY (520)
<i>Parry, Islands</i>	<i>Canada</i>	CA (404)
<i>Pedras Tinhosas, Islands</i>	<i>Sao Tome and Principe</i>	ST (311)
<i>Pemba, Island</i>	<i>Tanzania, United Republic of</i>	TZ (352)
<i>Penghu, Islands</i>	<i>Taiwan</i>	TW (736)
<i>Peñón de Alhucemas</i>	<i>Melilla</i>	XL (023)
<i>Peñón de Vélez de la Gomera</i>	<i>Melilla</i>	XL (023)
<i>Perim, Island</i>	<i>Yemen</i>	YE (653)
Peru		PE (504)
<i>Pescadores, Islands</i>	<i>Taiwan</i>	TW (736)
<i>Peter 1st, Island</i>	<i>Antarctica</i>	AQ (891)
<i>Peter, Island</i>	<i>Virgin Islands, British</i>	VG (468)
<i>Petit Martinique, Island</i>	<i>Grenada</i>	GD (473)
Philippines		PH (708)
<i>Phoenix, Island</i>	<i>Kiribati</i>	KI (812)
<i>Pico, Island</i>	<i>Portugal</i>	PT (010)
<i>Pines, Island</i>	<i>New Caledonia</i>	NC (809)
<i>Pinos, Island</i>	<i>Cuba</i>	CU (448)
Pitcairn		PN (813)
<i>Platte, Island</i>	<i>Seychelles</i>	SC (355)
<i>Pohnpei</i>	<i>Micronesia, Federated States of</i>	FM (823)
Poland		PL (060)
<i>Polynesia, French</i>	<i>French Polynesia</i>	PF (822)
<i>Ponape</i>	<i>Micronesia, Federated States of</i>	FM (823)
<i>Porto Santo, Island</i>	<i>Portugal</i>	PT (010)
Portugal		PT (010)
<i>Praslin, Island</i>	<i>Seychelles</i>	SC (355)
<i>Prince Charles Island</i>	<i>Norway</i>	NO (028)
<i>Prince Edouard</i>	<i>South Africa</i>	ZA (388)
<i>Principe, Island</i>	<i>Sao Tome and Principe</i>	ST (311)
<i>Providence, Island</i>	<i>Seychelles</i>	SC (355)
<i>Providencia Island</i>	<i>Colombia</i>	CO (480)
<i>Puerto Rico, Island</i>	<i>United States</i>	US (400)

Q		
Qatar		QA (644)
Queen Maud Land	Antarctica	AQ (891)
Quemoy, Islands	Taiwan	TW (736)
R		
Raivavaé, Island	French Polynesia	PF (822)
Ralik, Islands	Marshall Islands	MH (824)
Rapa, Island	French Polynesia	PF (822)
Rarotonga	Cook Islands	CK (837)
Ras al Khaimah	United Arab Emirates	AE (647)
Raso, Island	Cabo Verde	CV (247)
Ratak, Islands	Marshall Islands	MH (824)
Récifs, Islands	Seychelles	SC (355)
Redonda, Island	Antigua and Barbuda	AG (459)
Republic of Palau	Palau	PW (825)
Republic of the Congo, Democratic	Congo, Democratic Republic of	CD (322)
Republic, Central African	Central African Republic	CF (306)
Republic, Czech	Czechia	CZ (061)
Republic, Dominican	Dominican Republic	DO (456)
Republic, Former Yugoslav - of Macedonia	North Macedonia	MK (096)
Réunion, Island	France	FR (001)
Rimatara, Island	French Polynesia	PF (822)
Rio Muni	Equatorial Guinea	GQ (310)
Rodrigues, Island	Mauritius	MU (373)
Rolas, Island	Sao Tome and Principe	ST (311)
Romania		RO (066)
Rombo, Island	Cabo Verde	CV (247)
Rose, Island	American Samoa	AS (830)
Ross Dependency	Antarctica	AQ (891)
Rota, Island	Northern Mariana Islands	MP (820)
Rotuma, Island	Fiji	FJ (815)
Rurutu, Island	French Polynesia	PF (822)
Russian Federation		RU (075)
Rwanda		RW (324)
S		
Saaremaa, Island	Estonia	EE (053)
Saba, Island	Bonaire, Sint Eustatius and Saba	BQ (477)
Sabah	Malaysia	MY (701)
Sabana, Archipelago	Cuba	CU (448)
Saint Barthélemy		BL (466)
Saint Helena	Saint Helena, Ascension and Tristan da Cunha	SH (329)
Saint Helena, Ascension and Tristan da Cunha		SH (329)
Saint Lucia		LC (465)
Saint Paul, Island	French Southern Territories	TF (894)
Saint Pierre and Miquelon		PM (408)
Saint-Pierre, Island	Seychelles	SC (355)
Saipan, Island	Northern Mariana Islands	MP (820)
Sakhalin, Island	Russian Federation	RU (075)
Sal, Island	Cabo Verde	CV (247)
Sala y Gomez, Island	Chile	CL (512)
Salt Cay, Island	Turks and Caicos Islands	TC (454)
Salt, Island	Virgin Islands, British	VG (468)
Samoa		WS (819)
San Ambrosio, Island	Chile	CL (512)
San Andrés Islands	Colombia	CO (480)
San Cristobal	Ecuador	EC (500)
San Félix, Island	Chile	CL (512)
San Marino		SM (047)
San Salvador, Island	Bahamas	BS (453)
Santa Cruz Islands	Solomon Islands	SB (806)

<i>Santa Luzia, Island</i>	<i>Cabo Verde</i>	CV (247)
<i>Santa Maria, Island</i>	<i>Portugal</i>	PT (010)
<i>Santiago, Island</i>	<i>Cabo Verde</i>	CV (247)
<i>Santo Antão, Island</i>	<i>Cabo Verde</i>	CV (247)
<i>Santo, Island</i>	<i>Vanuatu</i>	VU (816)
<i>São Jorge, Island</i>	<i>Portugal</i>	PT (010)
<i>São Miguel, Island</i>	<i>Portugal</i>	PT (010)
<i>São Nicolau, Island</i>	<i>Cabo Verde</i>	CV (247)
Sao Tome and Principe	ST (311)	ST (311)
<i>Sao Tome, Island</i>	<i>Sao Tome and Principe</i>	ST (311)
<i>São Vicente, Island</i>	<i>Cabo Verde</i>	CV (247)
<i>Saona Island</i>	<i>Dominican Republic</i>	DO (456)
<i>Sarawak</i>	<i>Malaysia</i>	MY (701)
<i>Sardinia, Island</i>	<i>Italy</i>	IT (005)
<i>Sark, Island</i>	<i>United Kingdom</i>	GB (006)
Saudi Arabia	SA (632)	SA (632)
<i>Savai'i, Island</i>	<i>Samoa</i>	WS (819)
Senegal	SN (248)	SN (248)
Serbia	XS (098)	XS (098)
<i>Serbia and Montenegro</i>	<i>Kosovo</i>	XK (095)
<i>Serbia and Montenegro</i>	<i>Montenegro</i>	ME (097)
<i>Serbia and Montenegro</i>	<i>Serbia</i>	XS (098)
<i>Severnya Zemlya</i>	<i>Russian Federation</i>	RU (075)
Seychelles	SC (355)	SC (355)
<i>Sharjah</i>	<i>United Arab Emirates</i>	AE (647)
<i>Sherbro, Island</i>	<i>Sierra Leone</i>	SL (264)
<i>Shikoku</i>	<i>Japan</i>	JP (732)
<i>Siberian, New - Archipelago</i>	<i>Russian Federation</i>	RU (075)
<i>Sicily, Island</i>	<i>Italy</i>	IT (005)
Sierra Leone	SL (264)	SL (264)
<i>Sikkim</i>	<i>India</i>	IN (664)
<i>Silhouette, Island</i>	<i>Seychelles</i>	SC (355)
Singapore	SG (706)	SG (706)
<i>Sint Eustatius, Island</i>	<i>Bonaire, Sint Eustatius and Saba</i>	BQ (477)
Sint Maarten (Dutch part)	SX (479)	SX (479)
<i>Sitrah, Island</i>	<i>Bahrain</i>	BH (640)
Slovakia	SK (063)	SK (063)
Slovenia	SI (091)	SI (091)
<i>Snares Island</i>	<i>New Zealand</i>	NZ (804)
<i>Snares Islands</i>	<i>New Zealand</i>	NZ (804)
<i>Society, Islands</i>	<i>French Polynesia</i>	PF (822)
<i>Socotra, Island</i>	<i>Yemen</i>	YE (653)
Solomon Islands	SB (806)	SB (806)
Somalia	SO (342)	SO (342)
<i>Sombrero, Island</i>	<i>Anguilla</i>	AI (446)
<i>Somerset, Island</i>	<i>Bermuda</i>	BM (413)
South Africa	ZA (388)	ZA (388)
<i>South Georgia</i>	<i>South Georgia and South Sandwich Islands</i>	GS (893)
South Georgia and South Sandwich Islands	GS (893)	GS (893)
<i>South Korea</i>	<i>Korea, Republic of</i>	KR (728)
<i>South Orkney, Islands</i>	<i>Antarctica</i>	AQ (891)
<i>South Ossetia</i>	<i>Georgia</i>	GE (076)
<i>South Sandwich, Islands</i>	<i>South Georgia and South Sandwich Islands</i>	GS (893)
<i>South Shetland, Islands</i>	<i>Antarctica</i>	AQ (891)
<i>South Solomon, Island</i>	<i>Solomon Islands</i>	SB (806)
South Sudan	SS (225)	SS (225)
<i>South Yemen</i>	<i>Yemen</i>	YE (653)
<i>Southern and Antarctic Territories</i>	<i>Antarctica</i>	AQ (891)
<i>Southern Grenadine Islands</i>	<i>Grenada</i>	GD (473)
<i>Southern, French- Territories</i>	<i>French Southern Territories</i>	TF (894)
Spain	ES (011)	ES (011)
<i>Spitsbergen, Island</i>	<i>Norway</i>	NO (028)

Sri Lanka		LK (669)
<i>St Barthélemy, Island</i>	<i>Saint Barthélemy</i>	BL (466)
<i>St Brandon, Islands</i>	<i>Mauritius</i>	MU (373)
<i>St Christopher</i>	<i>St Kitts and Nevis</i>	KN (449)
<i>St Croix, Island</i>	<i>Virgin Islands (US)</i>	VI (457)
<i>St David, Island</i>	<i>Bermuda</i>	BM (413)
<i>St George, Island</i>	<i>Bermuda</i>	BM (413)
<i>St Helena</i>	<i>Saint Helena, Ascension and Tristan da Cunha</i>	SH (329)
<i>St John, Island</i>	<i>Virgin Islands (US)</i>	VI (457)
<i>St Kitts</i>	<i>St Kitts and Nevis</i>	KN (449)
St Kitts and Nevis		KN (449)
<i>St Martin, Island, northern part of</i>	<i>France</i>	FR (001)
<i>St Martin, Island, southern part of</i>	<i>Sint Maarten (Dutch part)</i>	SX (479)
<i>St Paul, Island</i>	<i>French Southern Territories</i>	TF (894)
<i>St Thomas, Island</i>	<i>Virgin Islands (US)</i>	VI (457)
St Vincent and the Grenadines		VC (467)
<i>St Vincent, Island</i>	<i>St Vincent and the Grenadines</i>	VC (467)
<i>Staten Island</i>	<i>Argentina</i>	AR (528)
<i>States of Micronesia</i>	<i>Micronesia, Federated States of</i>	FM (823)
<i>Stoncutters, Islands</i>	<i>Hong Kong</i>	HK (740)
Sudan		SD (224)
<i>Sulawesi, Island</i>	<i>Indonesia</i>	ID (700)
<i>Sumatra, Island</i>	<i>Indonesia</i>	ID (700)
Suriname		SR (492)
<i>Surprise, Islands</i>	<i>New Caledonia</i>	NC (809)
<i>Svalbard archipelago</i>	<i>Norway</i>	NO (028)
<i>Sverdrupp, Islands</i>	<i>Canada</i>	CA (404)
<i>Swains, Island</i>	<i>American Samoa</i>	AS (830)
<i>Swan, Islands</i>	<i>Honduras</i>	HN (424)
<i>Swaziland</i>	<i>Eswatini</i>	SZ (393)
Sweden		SE (030)
Switzerland		CH (039)
<i>Syria</i>	<i>Syrian Arab Republic</i>	SY (608)
Syrian Arab Republic		SY (608)
T		
<i>Tahiti, Island</i>	<i>French Polynesia</i>	PF (822)
Taiwan		TW (736)
Tajikistan		TJ (082)
<i>Tanganyika</i>	<i>Tanzania, United Republic of</i>	TZ (352)
<i>Tanna, Island</i>	<i>Vanuatu</i>	VU (816)
Tanzania, United Republic of		TZ (352)
<i>Ta'u, Island</i>	<i>American Samoa</i>	AS (830)
<i>Tenerife, Island</i>	<i>Spain</i>	ES (011)
<i>Terceira, Island</i>	<i>Portugal</i>	PT (010)
<i>Territories, French Southern</i>	<i>French Southern Territories</i>	TF (894)
<i>Territory of Campione d'Italia</i>	<i>Italy</i>	IT (005)
<i>Territory, Australian Antarctic</i>	<i>Antarctica</i>	AQ (891)
<i>Territory, British Antarctic</i>	<i>Antarctica</i>	AQ (891)
<i>Territory, British Indian Ocean</i>	<i>British Indian Ocean Territory</i>	IO (357)
<i>Territory, German - of Büsingen</i>	<i>Switzerland</i>	CH (039)
Thailand		TH (680)
<i>The municipality of Campione d'Italia</i>	<i>Italy</i>	IT (005)
<i>Three Kings, Islands</i>	<i>New Zealand</i>	NZ (804)
<i>Tierra del Fuego</i>	<i>Argentina</i>	AR (528)
<i>Tierra del Fuego</i>	<i>Chile</i>	CL (512)
<i>Timor, Island</i>	<i>Indonesia</i>	ID (700)
Timor-Leste		TL (626)
<i>Tinian, Island</i>	<i>Northern Mariana Islands</i>	MP (820)
<i>Tobago, Island</i>	<i>Trinidad and Tobago</i>	TT (472)
Togo		TG (280)
Tokelau		TK (839)
Tonga		TO (817)

<i>Tongatapu, Island</i>	<i>Tonga</i>	TO (817)
<i>Tortola</i>	<i>Virgin Islands, British</i>	VG (468)
<i>Tortue, Island</i>	<i>Haiti</i>	HT (452)
Trinidad and Tobago		TT (472)
<i>Trinidad, Island</i>	<i>Trinidad and Tobago</i>	TT (472)
<i>Tristan da Cunha, Archipelago</i>	<i>Saint Helena, Ascension and Tristan da Cunha</i>	SH (329)
<i>Troбрианд, Islands</i>	<i>Papua New Guinea</i>	PG (801)
<i>Truk</i>	<i>Micronesia, Federated States of</i>	FM (823)
<i>Tuamotu archipelago</i>	<i>French Polynesia</i>	PF (822)
<i>Tubuai, Island</i>	<i>French Polynesia</i>	PF (822)
Tunisia		TN (212)
<i>Turkey</i>	<i>Türkiye</i>	TR (052)
Türkiye		TR (052)
Turkmenistan		TM (080)
Turks and Caicos Islands		TC (454)
<i>Turks, Island</i>	<i>Turks and Caicos Islands</i>	TC (454)
<i>Turneffe, Islands</i>	<i>Belize</i>	BZ (421)
<i>Tutuila, Island</i>	<i>American Samoa</i>	AS (830)
Tuvalu		TV (807)
U		
Uganda		UG (350)
Ukraine		UA (072)
<i>Ulster</i>	<i>United Kingdom</i>	GB (006)
<i>Umm al Qaiwain</i>	<i>United Arab Emirates</i>	AE (647)
<i>Union, Island</i>	<i>St Vincent and the Grenadines</i>	VC (467)
United Arab Emirates		AE (647)
United Kingdom		GB (006)
United States Minor Outlying Islands		UM (832)
United States		US (400)
<i>Upolu, Island</i>	<i>Samoa</i>	WS (819)
<i>Upper Nagorno - Karabakh</i>	<i>Azerbaijan</i>	AZ (078)
<i>Upper Volta</i>	<i>Burkina Faso</i>	BF (236)
Uruguay		UY (524)
<i>Uvea, Island</i>	<i>Wallis and Futuna</i>	WF (811)
Uzbekistan		UZ (081)
V		
<i>Vache, Île à</i>	<i>Haiti</i>	HT (452)
<i>Vanua Levu, Island</i>	<i>Fiji</i>	FJ (815)
Vanuatu		VU (816)
<i>Vatican</i>	<i>Holy See</i>	VA (045)
<i>Vava'u, Islands</i>	<i>Tonga</i>	TO (817)
Venezuela, Bolivarian Republic of		VE (484)
<i>Victoria, Island</i>	<i>Canada</i>	CA (404)
<i>Vieques, Island</i>	<i>United States</i>	US (400)
Viet Nam		VN (690)
<i>Virgin Gorda</i>	<i>Virgin Islands, British</i>	VG (468)
Virgin Islands (US)		VI (457)
Virgin Islands, British		VG (468)
<i>Virgin, (US) Islands</i>	<i>Virgin Islands (US)</i>	VI (457)
<i>Virgin, British- Islands</i>	<i>Virgin Islands, British</i>	VG (468)
<i>Visayas archipelago</i>	<i>Philippines</i>	PH (708)
<i>Viti Levu, Island</i>	<i>Fiji</i>	FJ (815)
W		
<i>Wake, Island</i>	<i>United States Minor Outlying Islands</i>	UM (832)
Wallis and Futuna		WF (811)
<i>Wallis, Islands</i>	<i>Wallis and Futuna</i>	WF (811)
<i>Walpole, Island</i>	<i>New Caledonia</i>	NC (809)
<i>Warbah, Island</i>	<i>Kuwait</i>	KW (636)
<i>Wellington, Island</i>	<i>Chile</i>	CL (512)
<i>West Bank</i>	<i>Palestinian Territory, Occupied</i>	PS (625)

Western Sahara		EH (229)
<i>Western Samoa</i>	<i>Samoa</i>	<i>WS (819)</i>
<i>Windward, Islands</i>	<i>French Polynesia</i>	<i>PF (822)</i>
<i>Windward, Netherlands Islands</i>	<i>Bonaire, Sint Eustatius and Saba</i>	<i>BQ (477)</i>
<i>Windward, Netherlands Islands</i>	<i>Sint Maarten (Dutch part)</i>	<i>SX (479)</i>
<i>Woodlark, Island</i>	<i>Papua New Guinea</i>	<i>PG (801)</i>
<i>Wrangel, Island</i>	<i>Russian Federation</i>	<i>RU (075)</i>
Y		
<i>Yap</i>	<i>Micronesia, Federated States of</i>	<i>FM (823)</i>
Yemen		YE (653)
<i>York, Duke of - Islands</i>	<i>Papua New Guinea</i>	<i>PG (801)</i>
<i>Yugoslav, Former - Republic of Macedonia</i>	<i>North Macedonia</i>	<i>MK (096)</i>
Z		
<i>Zaire</i>	<i>Congo, Democratic Republic of</i>	<i>CD (322)</i>
Zambia		ZM (378)
<i>Zanzibar, Island</i>	<i>Tanzania, United Republic of</i>	<i>TZ (352)</i>
<i>Zealand, Island</i>	<i>Denmark</i>	<i>DK (008)</i>
<i>Zemlya, Novaya</i>	<i>Russian Federation</i>	<i>RU (075)</i>
<i>Zemlya, Zevernya</i>	<i>Russian Federation</i>	<i>RU (075)</i>
<i>Zevernya Zemlya</i>	<i>Russian Federation</i>	<i>RU (075)</i>
Zimbabwe		ZW (382)

GETTING IN TOUCH WITH THE EU

In person

All over the European Union there are hundreds of Europe Direct information centres. You can find the address of the centre nearest you at: https://europa.eu/european-union/contact_en

On the phone or by email

Europe Direct is a service that answers your questions about the European Union. You can contact this service:

- by freephone: 00 800 6 7 8 9 10 11 (certain operators may charge for these calls),
- at the following standard number: +32 22999696 or
- by email via: https://europa.eu/european-union/contact_en

FINDING INFORMATION ABOUT THE EU

Online

Information about the European Union in all the official languages of the EU is available on the Europa website at: https://europa.eu/european-union/index_en

EU publications

You can download or order free and priced EU publications at: <https://op.europa.eu/en/publications>. Multiple copies of free publications may be obtained by contacting Europe Direct or your local information centre (see https://europa.eu/european-union/contact_en).

EU law and related documents

For access to legal information from the EU, including all EU law since 1952 in all the official language versions, go to EUR-Lex at: <http://eur-lex.europa.eu>

Open data from the EU

The EU Open Data Portal (<http://data.europa.eu/euodp/en>) provides access to datasets from the EU. Data can be downloaded and reused for free, for both commercial and non-commercial purposes.

European business statistics geonomenclature applicable to European statistics on international trade in goods

The purpose of this publication is to provide the compilers and users of European statistics on international trade in goods with sound information on the nomenclature used to classify the reporting and partner countries. Besides including the latest version of the nomenclature of countries and territories for the European statistics on international trade in goods — known as the ‘Geonomenclature’ and abbreviated to GEONOM —, it also contains all the supplementary information that is essential to understand the content of this country classification and the evolution of its codes. A further aim of this publication is to document the geographical and economic areas covered by the trade in goods statistics as disseminated by Eurostat.

For more information
<https://ec.europa.eu/eurostat/>