



# Business Innovation Observatory



## Advanced Manufacturing

## New Manufacturing Engineering

*Case study 2*

Enterprise  
and Industry

*The views expressed in this report, as well as the information included in it, do not necessarily reflect the opinion or position of the European Commission and in no way commit the institution.*

# **Advanced Manufacturing**

New Manufacturing Engineering

Business Innovation Observatory  
Contract No 190/PP/ENT/CIP/12/C/N03C01

**Authors:** Laurent Probst, Erica Monfardini, Laurent Frideres, Dawit Demetri, Alain Kauffmann & Steven Clarke, PwC Luxembourg.

**Coordination:** Directorate-General for Enterprise and Industry, Directorate B “Sustainable Growth and EU 2020”, Unit B3 “Innovation Policy for Growth”.

European Union, September 2013.

# Table of Contents

|                                                            |    |
|------------------------------------------------------------|----|
| 1. Executive summary                                       | 2  |
| 2. New manufacturing engineering in advanced manufacturing | 3  |
| 3. The trend's socio-economic relevance                    | 5  |
| 3.1. NME's socio-economic benefits                         | 5  |
| 3.2. Companies offering and applying NME processes         | 6  |
| 3.3. The market potential of NME                           | 10 |
| 3.4. Client perspectives related to the uptake of NME      | 11 |
| 4. Drivers and obstacles                                   | 13 |
| 4.1. Rethinking the client-supplier relationship           | 13 |
| 4.2. Making potential clients aware of NME competences     | 13 |
| 4.3. The importance of access to finance for NME           | 14 |
| 4.4. Developing an SME-friendly business environment       | 14 |
| 4.5. Adjusting to changing employment demand               | 15 |
| 5. Policy recommendations                                  | 16 |
| 6. Appendix                                                | 17 |
| 6.1. Interviews                                            | 17 |
| 6.2. Websites                                              | 17 |
| 6.3. References                                            | 17 |

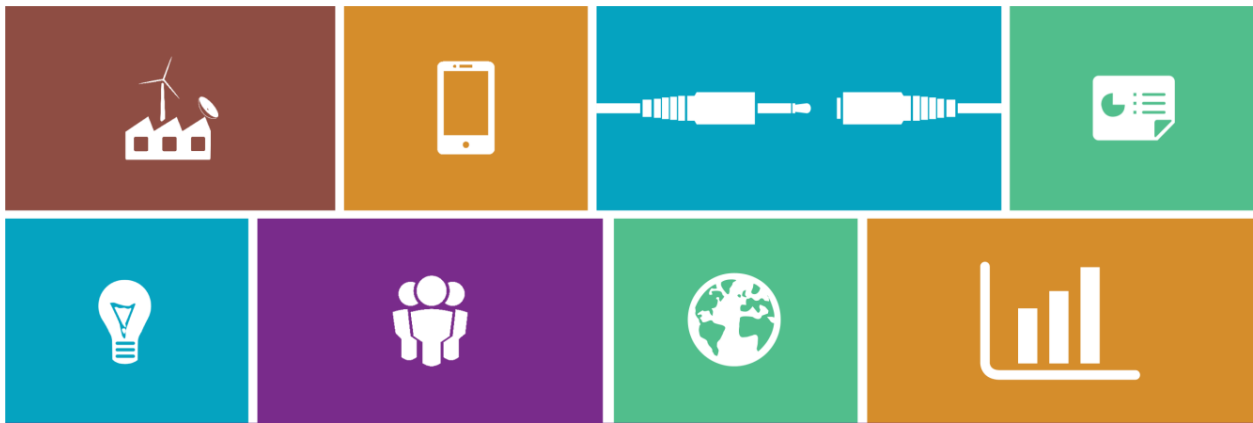

# 1. Executive summary

The resurgence of the manufacturing sector in the United States, along with Asia's capture of traditionally European value chains, poses a threat to Europe's position in manufacturing's world order. Yet manufacturing's increasingly competitive environment also presents Europe with an opportune moment to further the continent's transition from traditional to advanced manufacturing.

To make this transition, Europe ought not to solely focus on product innovation but must also identify the processes that provide manufacturing with the means to create the products of tomorrow at an industrial scale. **New Manufacturing Engineering (NME)** has the potential to make a significant contribution to Europe achieving this goal. NME draws on engineering know-how to re-organise manufacturing processes into novel production patterns within factory units, which are subsequently better equipped to respond to global demand.

Yet NME in Europe is hindered by a number of obstacles that ultimately prevent the continent from securing an optimum share of the estimated EUR 750 billion advanced manufacturing market expected in 2020. Challenges inhibiting client uptake of the NME trend include the need for suppliers to demonstrate that advanced processes are **cost effective, flexible, traceable** and **supportive**.

From a supplier's perspective, SMEs suffer from a lack of both access to finance and business-friendly environments. In response to this, Europe should see how it can **improve access to finance for innovative SMEs and mid-caps**, thereby filling the financing void left by banks constrained by increased capital requirements. In order to do so, Europe may seek to scale-up its financial support for such enterprises by adopting guarantee instruments that allow commercial banks to leverage on public sector funds. In addition, Europe could develop a clear communication

strategy for increasing the innovative SMEs and mid-caps' awareness of such financial instruments.

Europe must also determine how it can **increase prospective clients' awareness of NME competences** and their potential benefits to firm growth and survival. The public sector could achieve this by acting as a facilitator of awareness raising activities, providing a forum from which suppliers can inform clients of how they can help improve client productivity by designing-to-manufacture. Furthermore, such forums should provide clients with a platform from which they can share case studies on how suppliers have improved their manufacturing processes by integrating, inter alia, additive manufacturing or automation technologies. These forums could also emphasise the need for European manufacturing to rethink the client-supplier relationship by viewing it as a mutually **beneficial bi-lateral partnership** that engages NME partners early, enabling the reduction of costs and risks related to the re-organisation of manufacturing processes.

Finally, Europe needs to examine how it can meet employment demand by **improving access to highly skilled labour** that is relevant to advanced manufacturing. To do so, Europe may further develop its skilled labour pool by mapping clear career paths, tackling skill shortages in various engineering disciplines while increasing access to initial vocation training and education programmes, as well as continuing professional development schemes.

Should such actions be implemented for nurturing the NME business innovation trend, the continent would be well-placed to: capture a greater share of the advanced manufacturing market; benefit from the creation of knowledge-intensive jobs relevant to advanced manufacturing; and take advantage of the return of volume production to Europe.



## 2. New manufacturing engineering in advanced manufacturing

In the context of manufacturing, process improvement is needed to better the steps through which raw materials are modified and transformed into a final product. This need came to the fore in the 1980s, when East Asian companies were out-competing their Western counterparts by manufacturing high performance and high quality products in a reliable and efficient manner. In response to this, Western companies made fundamental changes to their operations, whether through their integration of total quality management (TQM) or their mimicking of the just-in-time (JIT) processes adopted by the likes of Toyota<sup>2</sup>.

*[T]hose who design the products of tomorrow will have to think about how to produce them as well. – High Level Group on KETs<sup>1</sup>*

Today, European manufacturers are entering a new paradigm of global competition, as there is increasing

*The concept of manufacturing engineering – the way that processes and production are organised in novel production patterns within factory units able to respond flexibly to global demand – is the core of manufacturing development. – High-Level Group on Manufuture<sup>3</sup>*

pressure on manufacturers to engineer new processes that derive from advanced machines, parts and material handling systems. In doing so, manufacturers are drawing on a new phenomenon, **New Manufacturing Engineering (NME)**. This phenomenon came to the fore as a pillar of Manufuture’s strategic research agenda<sup>4</sup> and is implicitly rooted in the know-how of a variety

of engineering disciplines and the tools applied by engineers in designing manufacturing systems that blend both virtual and real-world techniques.

By drawing on such skill-sets, NME is able to significantly contribute to Europe’s shift towards Advanced Manufacturing Systems (AMS). This transition is seen as a means to making the products of tomorrow, as AMS seek to manufacture high-tech products by applying newly developed processes<sup>1</sup> (see Figure 1).

**Figure 1: The position of processes within advanced manufacturing systems**

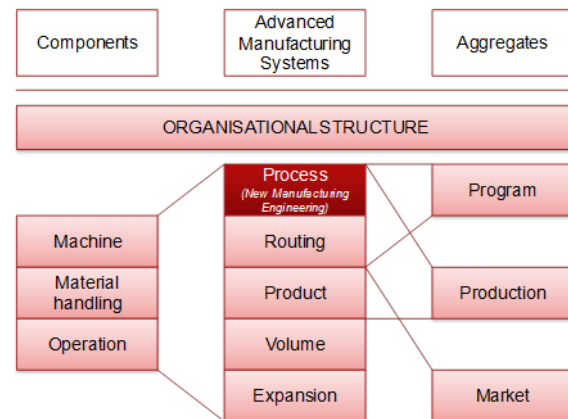

Source: PwC Analysis, Sethi & Sethi<sup>5</sup>

Furthermore, these innovative processes combined with knowledge-based manufacturing engineering are expected to bring **volume production back to Europe<sup>6</sup>**, thereby contributing to economic growth, job creation and knowledge generation in the continent’s manufacturing sector.

Within Europe’s advanced manufacturing engineering sector, the following four fields are areas in which NME is particularly pertinent: additive manufacturing; automation; fabrication; and precision engineering.

**Additive manufacturing** (or 3D printing) processes began in the 1980’s when computer-aided designs (CAD) were used to create layer-by-layer three-dimensional prototypes. The first form of additive manufacturing is referred to as rapid prototyping, which uses a liquid-based process that cures or solidifies a photosensitive polymer when an ultraviolet laser makes contact with the polymer. Other additive manufacturing processes have been developed over the past thirty years, including those that are solid- and powder-based (see Figure 2 on page 4).

<sup>1</sup> The Eurostat product approach to defining high-tech is based on the calculations of R&D intensity by groups of products (R&D expenditure/total sales). The groups classified as high-technology products are aggregated on the basis of the Standard international trade classification (SITC).



Figure 2: Additive manufacturing processes

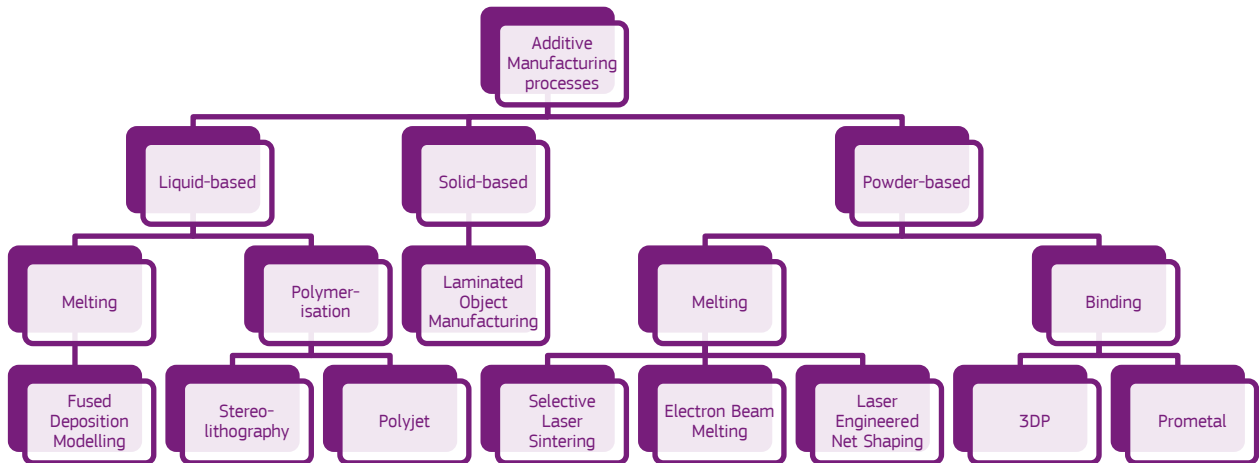

Source: Kaufui & Hernandez<sup>7</sup>

**Automation** is “the use of control systems and software to independently operate and monitor a mechanised system of industrial processes.”<sup>8</sup> In using mechatronics and computers to produce goods, automation may be divided into six categories:

- Numerical control, which involves the automation of machine tools through programmed commands. Most numerical control is undertaken via computers, applying computer numerical control (CNC), which manufacture specific products according to input programs.
- Adaptive control, which creates a control method with adaptable parameters for changing their response according to the desired model.
- Material handling, which involves the movement, storage, control and protection of materials throughout the manufacturing system.
- Robotics, which refers to automated machines that may replace the role of people in manufacturing processes.
- Assembly, which involves the mechanical act of combining components in manufacturing systems.
- Flexible fixturing, which enables machines to hold a variety of fixtures<sup>9</sup>.

**Fabrication** is a process that involves the manufacturing of an item from materials rather than ready-made components or parts. Types of fabrication include: metal fabrication, which involves the cutting, bending and assembling of metal; and semi-conductor device fabrication, which involves the creation of everyday electrical and electronic devices.

The fourth field in which NME is prominent is **precision engineering**, which refers to engineers’ ability to work at considerably finer tolerances than previously achieved by series manufacturing (see Figure 3). The outputs of precision engineering are items that differ in terms of size but are similar in terms of the relative accuracy with which they are produced<sup>10</sup>. Thus, precision engineering is a powerful technology, without which many high-tech products of a nano-, micro- or macro nature would not be realised<sup>11</sup>.

Figure 3: Trends in precision in machining

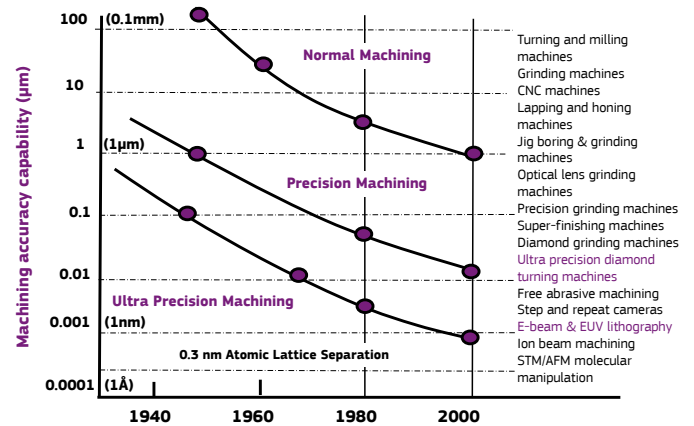

Source: Taniguchi<sup>12</sup>

By reviewing the benefits and potential markets of these four fields, this case study assesses the socio-economic relevance of improved manufacturing processes. In addition, the study draws on interviews conducted with firms employing NME to identify the drivers and obstacles behind NME’s novel business innovation trend.



## 3. The trend's socio-economic relevance

EU policy has a clear need to reverse the declining role of industry in the continent's economy, and more specifically, its manufacturing sector needs to overturn its declining contribution to the EU27's gross value added (Figure 4). This section of the case study tackles why this is the case and how the NME trend could help by: detailing NME's socio-economic benefits; assessing the market potential of the four fields in which NME is pertinent; and providing examples of companies employing advanced processes for innovative solutions.

**Figure 4: The manufacturing sector's declining contribution to the EU27's gross value added**

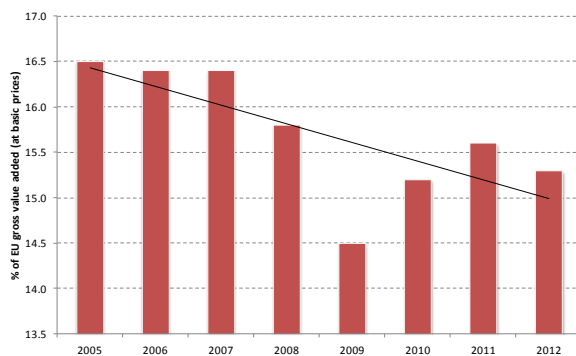

Source: PwC Analysis, Eurostat

### 3.1. NME's socio-economic benefits

Integrating improved processes into manufacturing sectors has the potential to lead to three forms of socio-economic benefits, namely: economic growth; improved social well-being; and reduced environmental impact. In order to analyse and prove the socio-economic benefits of a transversal trend like NME, it is necessary to provide sector examples. Consequently, the automation and additive manufacturing sectors are used hereunder to illustrate NME's socio-economic benefits.

3 million industrial jobs have been lost since the economic crisis began in late-2007 and industrial production is 10% lower than pre-crisis levels. Not all of these jobs and not all of this output have been lost as a result of declining global demand for products and services. As in many cases, European firms are succumbing to America's resurgent industrial sector and Asia's capture of traditionally European value chains<sup>13</sup>. Consequently, NME is needed to enhance **economic growth** in industry, and more precisely, manufacturing.

The global market for advanced manufacturing technologies is expected to be EUR 750 billion by 2020. The EU, with 35%

of the market share and 50% of the patents, is the world leader in the market but still has room for growth.

In order to foster its growth, Europe could, for instance, draw on automation's ability to improve the productivity of manufacturing, whether it be by:

- Increasing the yield produced for a given input by ensuring the utmost consistency and quality in manufacturing processes;
- Removing the need for humans to perform tedious tasks in manufacturing, enabling them to work in areas where their decision making skills and flexibility will be of greater added value; or
- Increasing the flexibility of the manufacturing process, thereby reducing batch sizes and inventory costs.<sup>14</sup>

Applying NME in European manufacturing is also expected to improve social well-being. For instance, Huang et al.<sup>15</sup> explain how additive manufacturing brings the following social benefits:

- Customised healthcare products to improve population health and quality of life; and
- Human interaction in product development.

The social well-being benefits deriving from additive manufacturing have been demonstrated by Materialise, which has used the capabilities of 3D printing to develop customised solutions for orthopaedic and cranio-maxillofacial surgery.

Additive manufacturing also demonstrates how improved manufacturing processes may result in a reduced **environmental impact**. As unlike traditional manufacturing methods, additive manufacturing does not remove materials to formulate products but instead, formulates products via a layer-by-layer approach that reduces waste and increases geometric accuracy.

Therefore, the application of NME processes in manufacturing is well-aligned with the strategies of Europe's Factories of the Future PPP, which seeks to:

- Transform enterprises due to the needs of customisation and sustainability, thus increasing the chances of success and global leadership;
- Boost the level of technologies for products and processes towards global leadership;



- Make Europe a global leader as both the producer and operator of factories and factory equipment with intelligent products, processes and new business models; and
- Activate the potential of novel enabling technologies and developing solutions for emerging markets<sup>16</sup>.

Furthermore, NME processes are likely to contribute to the Europe 2020 strategy for smart, sustainable and inclusive growth.

### 3.2. Companies offering and applying NME processes

In order to understand emerging solutions within the NME business innovation trend, this case study has interviewed 10 companies operating across the four aforementioned fields (additive manufacturing, automation, fabrication and precision engineering). A summary of the 10 companies and their success signals is provided in Table 1 below.

**Table 1: Summary table of the example companies interviewed for this case study**

| Field                         | Company name           | Primary location | Success signals                                                                                                                                                                                                                                                                                                                                                                                                                                                              |
|-------------------------------|------------------------|------------------|------------------------------------------------------------------------------------------------------------------------------------------------------------------------------------------------------------------------------------------------------------------------------------------------------------------------------------------------------------------------------------------------------------------------------------------------------------------------------|
| <b>Additive Manufacturing</b> | Materialise            | BE               | The company: represented Belgium at Europe's Most Competitive Business Awards Competition; and has the largest fused deposition modelling plant in Europe. The company's CEO: spoke at a TEDx event and at Industrial Technologies 2012; founded the Mimics Innovation Awards; and was voted the most influential figure in additive manufacturing.                                                                                                                          |
| <b>Automation</b>             | ATS Automation         | CA/DE            | The company has won, inter alia: the 2011 Brose Technik fur Automobile - Supplier of the Year.                                                                                                                                                                                                                                                                                                                                                                               |
|                               | evopro group           | HU               | The company has become a Siemens Solution Partner and a Microsoft Gold Partner. The company appeared in several categories in the 2012 TOP200 list published by the Figyelő.                                                                                                                                                                                                                                                                                                 |
|                               | Tekpak Automation Ltd. | IE/UK            | In 2013, the company won the PPMA award for Most Innovative Automation System and was shortlisted for Most Innovative Process or Packaging Machine. In 2012, the company won the PPMA award for Most Innovative Process or Packaging Machine.                                                                                                                                                                                                                                |
| <b>Fabrication</b>            | CDA GmbH               | DE               | The company has secured cooperation agreements with a leading engineering manufacturer, Häcker Automation.                                                                                                                                                                                                                                                                                                                                                                   |
|                               | kringlan composites    | CH               | The company has been granted the CTI Start-Up Label.                                                                                                                                                                                                                                                                                                                                                                                                                         |
|                               | Primoceler             | FI               | The company sold its first micro-welding machine in March, 2013.                                                                                                                                                                                                                                                                                                                                                                                                             |
| <b>Precision Engineering</b>  | CeNTI                  | PT               | The company's products won a place in the Top 5 and Top 50 of ISPO Textrends Forum. The company was awarded 1st Prize Clean Tech Bes Inovação 2010. The company has participated in six projects under the European Union's Seventh Framework Programme for Research and Development (5 are ongoing). The company has submitted 16 patents in the past 3 years.                                                                                                              |
|                               | Clifton                | EE               | The company secured venture capitalist investment upon its founding in 2000.                                                                                                                                                                                                                                                                                                                                                                                                 |
|                               | Zeeko Ltd.             | UK               | The company: won the 2012 MWP award for Best Specialised Machining/Manufacturing Equipment; and was shortlisted for the 2012 MWP award for Best Grinding/Finishing Equipment. The company supplies NASA and is a supplier to the European-Extremely Large Telescope Project. The company's CEO won the 2012 Leicester Mercury Business Executive of the Year Award. The company has 52 worldwide patents in the areas of grinding, metrology, and ultra-precision polishing. |





The success signals captured in Table 1 emanate from problems that companies have sought to remedy through their innovative solutions. Further information on the problem each company seeks to resolve is provided hereunder.

---

**Problem 1** – There is a lack of knowledge of additive manufacturing and how it can be used as an integrated solution for innovative product development for a better and healthier world.

---

*Innovative solution 1* – Materialise was founded in 1990 in Leuven, Belgium, and is a spin-off from KU Leuven. Initially, Materialise focused on developing research and development solutions for transferring data to additive manufacturing machines but today, Materialise’s service offering includes: technologies and materials, which help designers create products without limitations; software solutions, for incorporating additive manufacturing into product design, prototyping, or manufacturing; and consultancy, for developing customised software solutions for industry innovators. More recently, the firm has launched i-materialise, which is a production house that offers 3D printing services to designers.

*Chairs that started as a 3D printed master model*



Source: Materialise<sup>17</sup>

---

**Problem 2** – Global manufacturers often lack the synergy of experience, automation technology, and scale to advance factory automation solutions.

---

*Innovative solution 2* – ATS Automation, founded in 1978 in Cambridge, Canada, provides innovative, custom-designed automation solutions for manufacturers. Of the solutions ATS Automation provides, many are process-based manufacturing solutions, for instance those related to automation platforms, vision inspection, laser processing and ultra-high accuracy. Manufacturers that use such solutions include those operating in industries such as life sciences, computer/electronics, energy, transportation and consumer products

*High-accuracy laser processing system*

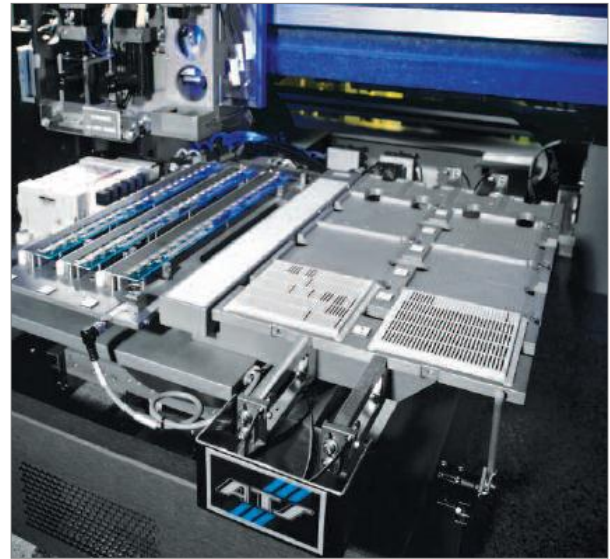

Source: ATS Automation<sup>18</sup>

---

**Problem 3** – Logistics systems under-utilise automated software solutions for handling systems.

---

*Innovative solution 3* – evopro group is an engineering company that was founded in Budapest, Hungary, in 2001. The firm was founded by 5 electrical engineers that sought to capitalise on a market opportunity. This market gap involved the conception, software planning, developing, commissioning, training and maintenance of the luggage transport and sorter system at Terminal 2 of Munich International Airport. Since performing this assignment and gaining specialist knowledge in this field, evopro group has expanded to a company of 1,000 employees. Furthermore the company’s service offering has expanded into: mechanical design, by focusing on controls and automation systems; research and development; system testing, which involves testing the functionality, practicability, and operations of various automation products; industrial automation by focusing on production lines; and energy systems by focusing on the design of electrical power transfer systems and mechanical solutions.

*A Mercedes production line designed by evopro*

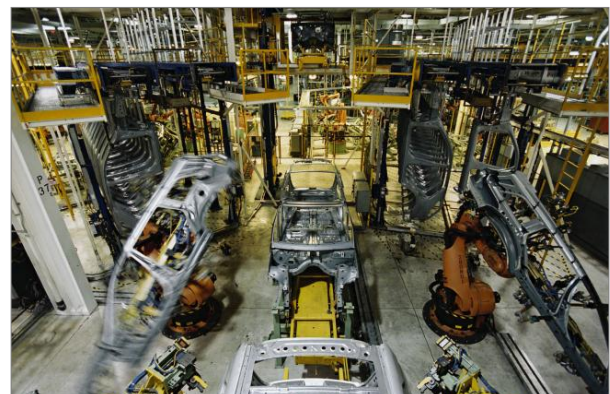

Source: evopro<sup>19</sup>



**Problem 4** – Robots have speed limitations when picking and placing products for end-of-line packaging.

*Innovative solution 4* – Tekpak Automation Ltd. was founded in Wexford, Ireland in September 2003. The company was initially an integrator of other companies' equipment but expanded its service offering when its managing director identified the abovementioned problem. This problem was seen as a market gap that could be filled by the products and services offered by Tekpak's design team and programmers. These products and services include Tekpak's robots, which have: innovative grippers that can handle an array of formats and multiple products at one time; vision-based systems that can be re-oriented to the product; and the ability to manoeuvre the product to align it correctly under the fixed position head. These features enable Tekpak robots to pick and place products multiple times faster than standard robots. As a result of these competitive advantages, Tekpak's automated process solutions are commonly used by high volume manufacturers of retail packaged goods and pharmaceutical products.

#### *Tekpak's Manufacturing and R&D Facility*



Source: Tekpak<sup>20</sup>

**Problem 5** – The optical storage media industry faced a number of challenges, including competing technologies and the significant erosion of prices and margins.

*Innovative solution 5* – CDA GmbH was founded in 1994 as an optical storage media manufacturer, producing CDs, DVDs, and BluRay discs. The company continues to produce such optical storage media but has broadened its activities by applying µ-functional solutions (a new process technology) to manufacture elements for microstructures. In doing so, CDA draws on its flexible manufacturing capabilities that facilitate the manufacturing of low, medium or high volumes. Further to being flexible, CDA's manufacturing processes are also cost-effective as they use polymers rather than traditional microstructure materials (glass and metals). The microstructures manufactured by CDA now account for approximately 70% of the company's revenues, and optical storage media account for the remaining 30%.

#### *CDA's printed electronics*

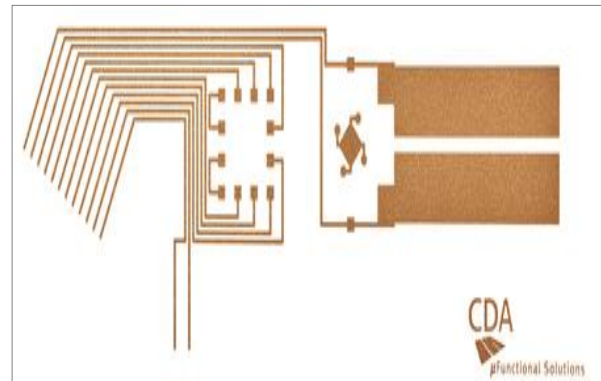

Source: CDA<sup>21</sup>

**Problem 6** – By not using new processes to develop advanced materials that reduce the weight of wheels, car manufacturers are missing out on the opportunity to improve their performance, while reducing their fuel consumption and carbon dioxide emission.

*Innovative solution 6* – kringlan composites was founded in April 2007, as a spin-off of ETH Zurich. Located in Otelfingen, Switzerland, kringlan aims to use advanced processes to produce thermoplastics that reduce the weight and cost of composite parts, while improving their properties (in particular impact properties). The company is primarily targeting the automotive industry but its processes and technologies could be applied in: aerospace; electric industry; and the paper industry. kringlan aims to industrialise its technology in late-2013.

#### *kringlan composites rims*



Source: kringlan composites<sup>22</sup>

**Problem 7** – Conventional bonding methods cannot be used for packaging sensitive components if hermetical encapsulation is needed. Conventional wafer level and other MEMS component bonding methods generate a lot of heat that can damage components.

*Innovative solution 7* – Primoceler is a company based in Tampere, Finland, which provides hermetic room temperature packaging and encapsulation technology. Primoceler achieves this by applying its laser micro-welding methodology, which is able to bond silicon and glass: hermetically (sealing prevents any damage by gases or moisture); without adhesives (using homogenous encapsulation that provides a strong and permanent seam); and



with a small heat-affected zone (eliminating the risk of damaging sensitive components). Technology can be used in wafer-level packaging as well as on-packaging individual components.

#### System overview of the laser bonding system

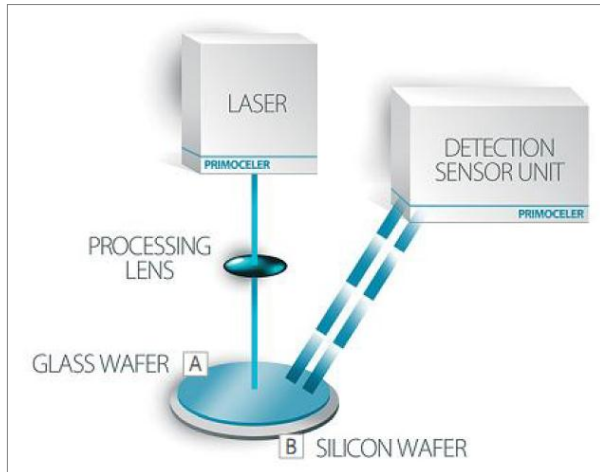

Source: Primoceler<sup>23</sup>

**Problem 8** – Processing facilities are needed in which the R&D, engineering and scaling-up production of innovative smart materials and devices may be performed.

*Innovative solution 8* – The Centre for Nanotechnology and Smart Materials (CeNTI) was founded in 2006, in Vila Nova de Famalicão, Portugal. The high-level shareholders in CeNTI are CITEVE, the University of Minho, the University of Porto, the University of CTIC, and the CEIIA. These shareholders launched CeNTI so that advanced processing facilities (2000m<sup>2</sup> in area) could drive the development of new materials, such as multicomponent fibres, smart materials/devices, multifunctional coatings, organic and printed devices, electronics and embedded systems, 3D fabrication, pilot and pre-series production. In turn, these materials may be incorporated into products, whether at the prototype, sample, or industrial stage of development.

#### CeNTI technology campus



Source: CeNTI<sup>24</sup>

**Problem 9** – The use of silicon as a semiconductor material for power diodes is approaching its theoretical limit for carrying high temperatures, frequencies, currents and block high voltages simultaneously.

*Innovative solution 9* – Clifton was founded in 2000 by semiconductor R&D specialists and venture capitalists. The high-tech company employs state-of-the-art technology for Gallium Arsenide (GaAs) crystal growth and chips manufacturing that have superior performance characteristics to incumbent Silicon power electronics devices. In doing so, Clifton invested EUR 7 million in a pilot plant in Tartu Science Park, Estonia. This plant is Clifton's main facility for Liquid Phase Epitaxy (LPE) technology, which is the company's proprietary know-how and competitive advantage.

#### Processing machinery at Clifton, Tartu Science Park



Source: Clifton<sup>25</sup>

**Problem 10** – During the period 1995-2005, techniques used for the manufacturing of optics were not appropriate for the freeform parts that the industry was demanding.

*Innovative solution 10* – Zeeko Ltd. was founded by Dr. David Walker and Richard Newman in 2000. Initially Zeeko focused on the optics industry's needs for polishing precision surfaces. In doing so, Zeeko developed a computer numerical control (CNC) machine that operates along 7-axes. Typical CNC machines in the industry had operated along 5-axes. Hence, Zeeko's competitive advantage lies in the two additional axes of its machines, both of which are used to polish freeform surfaces via its patented polishing heads. These polishing machines include the "ZeekoClassic" and "ZeekoJet", which can be used to polish client surfaces that may range in size from 1.5mm to 6m, and can polish most materials. In addition to being scalable, these ultra-precision polishing solutions are also cost-effective and deterministic<sup>2</sup>.

<sup>2</sup> Deterministic is an American term used to describe the process by which a machine uses CNC technology to make the shape of a part converge with its original design.



More recently, Zeeko has diversified its product offering in order to provide solutions to the entire precision surface chain, and so offers grinding and integrated metrology machinery, as well as software.

Corrective Polishing Machine: IRP 1000-1200



Source: Zeeko<sup>26</sup>

### 3.3. The market potential of NME

The market potential of advanced manufacturing systems shaped by NME is difficult to quantify as this business innovation trend is novel, and is used as an enabler for advanced manufacturing. Thus, to demonstrate the market potential of NME, forecasts for the growth of the global additive manufacturing and automation engineering markets have been used as a proxy.

In the case of 3D printing's market, it has the potential to grow as an advanced process in most areas of manufacturing but has been most applicable to: motor vehicles; consumer products; industrial machines; medical, dental; academic; and aerospace (see Figure 5).

Figure 5: 3D printing sales by end-market

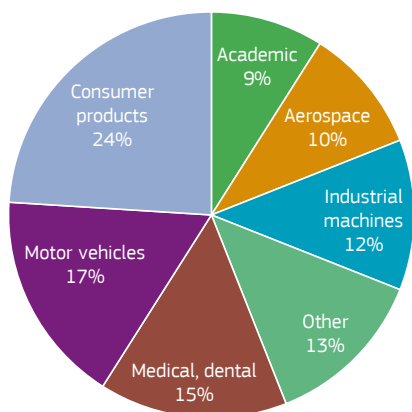

Source: IBISWorld and Wohlers Associates in Mitchell et al.<sup>8</sup>

Of these areas, motor vehicles accounts for one of the largest shares of the market, as it easily applies 3D printing processes for manufacturing end-products like engines and spare parts. The medical manufacturing segment is also a burgeoning part of additive manufacturing's market due to rising healthcare expenditure in emerging economies.

These areas of manufacturing have driven 3D printing's global market to grow from its size of USD 1.7 billion in 2011 to USD 2.2 billion in 2012. Yet this 29.4% growth rate is dwarfed by the average growth rate of low-cost so-called "personal" or desktop 3D printers, which has averaged 346% growth over the period 2008 to 2011. However, the growth in the sale of personal 3D printers to hobbyists, do-it-yourselfers, engineering students and universities is expected to slow, as it did in 2012.

Further indications of the field's growth potential is provided by General Electric (GE) Aviation's 2012 acquisition of Morris Technologies, a company focused on 3D printing, using the selective laser sintering method. This growing presence of conglomerates like GE in the additive manufacturing space, adds weight to the industry's bullish forecasts.

*"GE views additive manufacturing as a game-changing technology...By 2020, well over 100,000 end-use parts in GE/CFM engines will be produced through additive manufacturing. That's a huge change, and we believe a competitive advantage." – Randy Kappesser in Zilinski<sup>27</sup>*

The increased speed at which the additive manufacturing is growing brings Europe the opportunity of economic growth. This economic opportunity is reflected in the increased employment it brings, for instance, the number of people employed by Materialise has grown significantly over the past twenty years, and currently stands at 850 people, of which half are located in Europe (Figure 6).

Figure 6: Materialise's growth in personnel

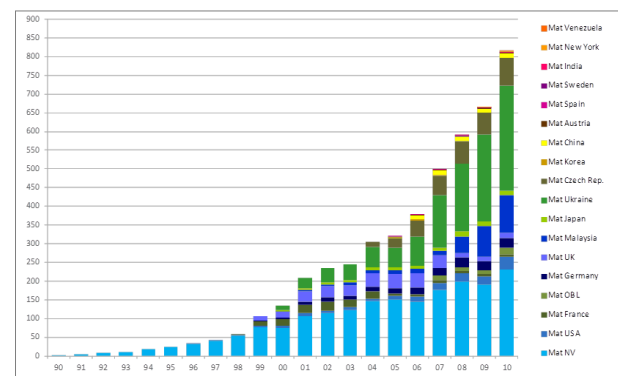

Source: Vancaeren<sup>28</sup>

Moving forward, 3D printing is expected to continue its trend of double-digit growth, as forecasts anticipate estimate that the 3D printing market will be worth USD 6 billion by 2017, and USD 10.8 billion by 2021<sup>29</sup>. Thus it would have taken the



3D printing market two decades to reach USD 1 billion in market size, five additional years to generate its second USD 1 billion, and at this rate it is expected to double again, to USD 4 billion, within the coming two years.

However, questions remain as to whether Europe will be able to capitalise on the socio-economic potential of the additive manufacturing market, as the uptake of 3D printers on the continent is far behind that of the US (Figure 7).

**Figure 7: 3D printing installations (1988-2010)**

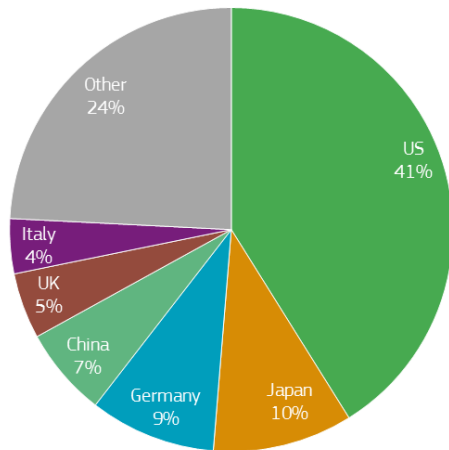

Source: IBISWorld and Wohlers Associates in Mitchell et al.<sup>8</sup>

Like additive manufacturing’s rapid growth potential, growth in the automation market is also expected to outstrip that of industrial production (see Table 2). In addition, the motor vehicles’ pre-eminence as an end-market for automation products and services draws similarities to additive manufacturing (Figure 8).

**Table 2: Automation market: bottom-up growth outlook**

| Year   | Industrial production | Industrial automation |
|--------|-----------------------|-----------------------|
| 2003   | 3.70%                 | 4.40%                 |
| 2004   | 5.40%                 | 8.50%                 |
| 2005   | 4.40%                 | 8.70%                 |
| 2006   | 5.50%                 | 11.40%                |
| 2007   | 5.70%                 | 10.00%                |
| 2008   | 0.50%                 | 6.80%                 |
| 2009   | -7.20%                | -11.50%               |
| 2010   | 9.60%                 | 6.30%                 |
| 2011   | 5.00%                 | 11.60%                |
| 2012E  | 3.70%                 | 7.00%                 |
| 2013E  | 4.90%                 | 6.30%                 |
| CAGR   | 3.50%                 | 6.00%                 |
| vs. IP | 1.0x                  | 1.7x                  |

Source: Mitchell et al.<sup>8</sup>

**Figure 8: Automation end markets by revenue (as % of USD 152 billion)**

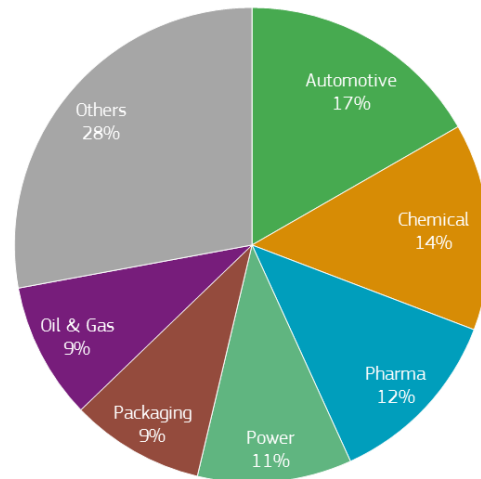

Source: Mitchell et al.<sup>8</sup>

The automation market’s growth potential is deeply embedded in:

- China’s wage inflation accelerating, due to labour shortages at the low-end.
- The Chinese government’s increasing focus on consumption, which has led to a ramp-up in investment in automation. For instance, in 2001, China’s demand for robots increased from 1% of total global demand in 2001, to 14% in 2011.
- The upturns in the cycles of key automation end-markets, including automotives and petrochemicals.
- A combination of the increased effectiveness of factory automation and low penetration rates in many markets.

Hence, if Europe wishes to reverse the decline in its manufacturing sector, the continent has a clear need to capitalise on areas of growth like additive manufacturing, automation, fabrication and precision engineering. If this can be achieved, Europe would be able to: capture a greater market share of these up-and-coming fields; benefit from the job creation triggered by these fields; and bring back volume production to Europe.

### 3.4. Client perspectives related to the uptake of NME

Yet in order to take advantage of the socio-economic benefits and market potential of the NME trend, Europe must understand the reasoning behind clients’ delayed uptake of advanced manufacturing processes and ought to emphasise how NME can capture the critical success factors clients seek. These critical success factors call for a **proof-of-concept** and a **cost-benefit** analysis that takes into consideration the amount of time, investment and



reorganisation required to implement the new processes, and the investment in new skills to ensure their sound operation.

Typical critical success factors analysed for the proof of concept of NME processes include: cost effectiveness; flexibility; traceability; and sales maintenance and support.

In the present global competitive environment, interviewees emphasised how clients seek cost-effectiveness when

*“The cost-effectiveness of the product is process-related. The deterministic nature of our approach is an advantage for our customers, who are able to use our machines to produce parts much faster and with fewer resources.”*

– Zeeko

adopting **lean approaches that optimise the consumption of human, raw material or energy resources**. The benefit of adopting such approaches would also contribute to the mitigation of long time-to-market risks that would otherwise lengthen the time taken to transition from concept design to high-tech product availability on

the market. Interviewees also highlighted the link between cost-effectiveness and sustainability.

CDA, for example, described how it reduces its costs by using heat recovered from production plants for its factory’s heating system. Similarly, Primoceler explained that although almost every new technology in a sense reduces costs, however its technology’s provides back-end cost savings, as the life-cycle of components produced by its laser welding technology is extended, thereby reducing maintenance and replacement costs.

**Flexibility** is the continuous re-use of existing infrastructures and processes for handling an array of manufacturing possibilities, thereby saving on the time and cost of implementing alternatives<sup>30</sup>. According to Mandelbaum<sup>31</sup>, flexibility can be categorised into two types:

- Action flexibility, whereby infrastructures and processes act to meet new circumstances; and
- State flexibility, whereby infrastructures and processes continue to operate effectively despite changes in the new environment.

The need for flexibility within factories, processes and products is seen by clients from both volume and scale

*“CDA provides a one-stop shop for customers to use their low, medium and high volume manufacturing capabilities. In addition, the customers can take advantage of their rapid prototyping exercise.”* – CDA

perspectives. Zeeko explained how its range of machines offered flexibility through its range of scales for corrective polishing solutions (from 1.5mm to 6m), while ATS Automation identified their unique selling point as the firm’s flexibility in scaling-up the manufacturing processes it had integrated into clients’ operations.

The two types of flexibility enable manufacturers to cope with uncertainty, while offering efficiency gains in economies of scope. A summary of the nature of uncertainty, the flexibility required, and the benefit of advanced processes is provided in Table 3.

**Table 3: The domain of manufacturing flexibility**

| Nature of uncertainty                    | Flexibility type | Ability of a process to...                                                 |
|------------------------------------------|------------------|----------------------------------------------------------------------------|
| Demand for the kinds of products offered | Mix              | “produce a number of different products at the same time”                  |
| Length of product life cycles            | Changeover       | “deal with additions to and subtractions from the mix over time”           |
| Appropriate product characteristics      | Modification     | “make functional changes in the product”                                   |
| Machine downtime                         | Rerouting        | “[change] the operating sequence through which the parts flow”             |
| Amount of aggregate product demand       | Volume           | “[easily make] changes in the aggregate amount of production”              |
| Meeting raw material standards           | Material         | “handle uncontrollable variations in compositions and dimensions of parts” |
| Timing of arrival of inputs              | Sequencing       | “reorganise the order in which different kinds of parts are [processed]”   |

Source: Schmenner & Tatikonda, and Gerwin

**Sales maintenance and support** was seen to be a success factor as it provided clients with greater assurance as to the reliability of the products and services they were purchasing. In the case of CDA, they provide pre-sales expertise and know-how to ensure that their prospective clients’ ideas are “manufacturable”. In Zeeko’s case, clients were attracted to Zeeko’s polishing solutions as they had confidence in Zeeko’s after-sales support, which includes installing features on Zeeko products that enable them to be operated remotely from Zeeko offices.

*“We provide support on how to run the machine. We also provide online support to the machine. You can monitor and operate the machine from the comfort of your own home. We have one customer that operates the machine from his smartphone.”* – Zeeko

Finally, **traceability**, which refers to a manufacturers ability to trace a product through its processing procedures or re-trace a product back to the manufacturer, and is deemed as a critical success factor for NME processes. Traceability systems, typically implemented by quality control departments, are used to help manufacturers improve the quality and consistency of the overall manufacturing process. Traceability systems achieve this by collating



measurement and/or processing data for reviewing different product variables, identifying product defects, improving inventory accounting and inventory control.

Materialise has recognised the importance of traceability in additive manufacturing's processes, and so has recently improved the product tracking and product tracing used for the segmentation process within its Mimics Innovation Suite. In so doing, Materialise provides its clients with a log of

information regarding processes used, which may be used for training purposes or recommending a workflow for similar cases<sup>32</sup>. Increasing the traceability of all parts produced is particularly important for Materialise's clients engaged in medical production and orthopaedic surgery, as it is of the utmost importance to such clients to be able to identify the sources of manufacturing errors.

## 4. Drivers and obstacles

To capitalise on these up-and-coming manufacturing fields, and create a business environment conducive to the aforementioned critical success factors, Europe must strengthen the drivers of the NME trend, while reducing its obstacles. These drivers and obstacles, further detailed hereunder, include: the access to finance for innovative SMEs; the development of an SME-friendly environment; making potential clients aware of NME competences; rethinking the client-supplier relationship; and adjusting to changing employment demand.

### 4.1. Rethinking the client-supplier relationship

The NME processes applied by companies often act as enablers for the manufacturing of state-of-the-art products. Yet to realise the socio-economic potential of such enablers, there is a growing need for clients to rethink their traditional relationship with suppliers. For instance, Sedlak<sup>33</sup> explains how clients are well-advised to engage automation partners early in the concept phase of the product development life cycle. In doing so, client-supplier relationships are converted into partnerships. These partnerships enable automation firms to design-to-automate, thereby reducing the total cost of a programme and a product's time to market, while identifying and mitigating risks (Figure 9).

Figure 9: Cost of change/time

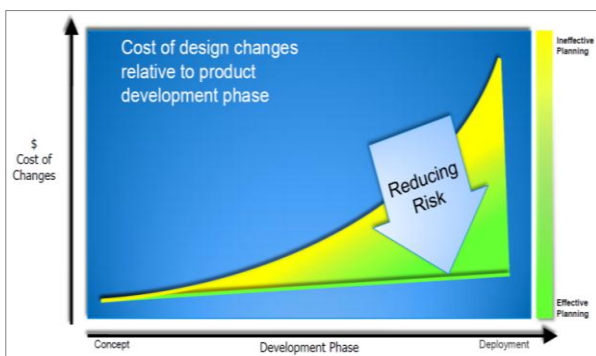

Source: ATS Automation<sup>34</sup>

### 4.2. Making potential clients aware of NME competences

Many of the companies interviewed for this case study offer advanced manufacturing processes that enable the production of high-tech products, reduce manufacturing costs and increase manufacturing flexibility. Yet such companies are facing obstacles in increasing market awareness of product and service potential.

*“We need to let people and clients know that this type of technology is available and enables new product designs by clients.” – Primoceler*

As it stands, companies use traditional means for marketing their products, for instance:

- **Tekpak** has opened a sales office in Leeds, in order to be in close proximity to its target market; and
- **Primoceler** attends conferences, trade fairs, and writes in industry journals.
- **Materialise** organises workshops with a variety of companies in different domains, in order to identify manufacturing problems that may be resolved through the integration of 3D printing processes into the process chain.

Yet many interviewees believe the public sector can do more in helping promote company technologies, particularly for companies hailing from Member States with small domestic markets, e.g. in Hungary and Finland. In the case of Hungary, evopro has had little in the way of public support for its internationalisation, and so has actively sought business in Germany, the UK, Saudi Arabia and wherever an opportunity arises. In contrast, Primoceler has benefitted from Tekes' international networks, particularly those providing Finland with connections to the Asian market.

*“As there is little investment coming into Hungary, there are also few business opportunities. Consequently, we are very much international.” – evopro*



### 4.3. The importance of access to finance for NME

*"We have a saying at the company that technology has no nationality. The key bit of technology you need to take your next product forward might not come from your country of origin." – Zeeko*

It was generally accepted among interviewees that the EU plays an influential role in financing research and development (R&D) but fails to provide sufficient financing for making technologies market mature, commercially produced, and/or internationally distributed. This financing gap is commonly referred to as the Valley of Death, and is seen as a reason why many technologies developed in Europe are being commercialised elsewhere.

There are two Valleys of Death, the first of which is attributed to a lack of early stage risk capital for start-ups, while the second Valley of Death occurs when support provided by the government for basic research tapers off. The Second Valley of Death inhibits innovations from becoming commercial products, services or processes, and so prevents real economic benefit being realised.

*"We have had a nightmare ride. So we have always gone back to the private angel investor, as well as friends and family. Thank goodness they are there, because no-one else is around to help." – Zeeko*

In terms of public sector or government sources of funding, Zeeko pointed to how public financiers make many promises with the drawbacks of huge amounts of bureaucracy, paperwork, and references to how help cannot be provided due to state aid. Consequently, the hand of Zeeko's founders was forced, as they had to turn to a private angel investor, and friends and family for financing. These angel investors provided Zeeko with sufficient financial resources during its loss-making years (2000-2005), but due to the financial crisis, have also been relied upon during Zeeko's profit generating years (2006 onwards).

The economic benefits of the technology emanating from Zeeko were developed in Europe but almost lost to the United States. The forerunning technology used by Zeeko was originally developed within University College London (UCL). A spin-off from UCL sought to capitalise on the technology but failed due to the company's:

- Lack of funding from the public sector; and
- Lack of vision and industrial focus from the spin-off's management team (comprising researchers and academics).

The more industrial-minded founders of Zeeko were aware of the technology's potential but were forced to wait for the complete decline and fall of the UCL spin-off, before purchasing the intellectual property. All the while, an entity in the US, which was applying similar polishing technologies,

was growing thanks to funding received from the US government.

The impact of the US competitor's headstart was worsened by a lack of public or private financing available for Zeeko to commercialise its technology. After all, Zeeko was founded the year of the dotcom bubble burst, and so Zeeko found it difficult to secure financial support. Furthermore, those venture capitalists willing to invest in Zeeko only offered onerous terms.

CDA also had a negative perception of the availability of public funding for its innovative activities, and counted itself lucky that all of its payments were being made from its own cash-flow. Similarly, Clifton was perplexed by Europe's desire to transition to an advanced manufacturing approach without significantly investing in small and medium enterprises (SMEs) with high risk-return potential.

*"My understanding is that Europe wants to engage in knowledge-based, high margin, high added value industry. So it seems a bit strange that the public sector does not like to take risks." – Clifton*

Further to the shortfall of public funding, companies interviewed also cited the lack of growth capital provided by banks to European companies. Interviewees explained how banks are limited in terms of the amount they can lend to growth companies, as their calculations are based on historical data and ignore growth potential. This shortcoming came to the fore in the case of Tekpak, whose end-of-line packaging solutions cater for large orders by multinationals. Yet as the box below demonstrates, Tekpak nearly lost a reference client due to financial constraints.

*"In the UK there is a huge market failure for what banks are supposed to be doing to support business in the UK. There is no money available to fund a company's growth." – Zeeko*

This was exemplified when Tekpak had received an order of 250,000 packaged devices with a large US multinational providing a 40% down-payment, on the condition that a bank provided a performance guarantee on behalf of Tekpak. However, the order almost fell-through due to the collateral demands of the bank, and it was only after a month of negotiations that a performance guarantee was secured from the bank. The terms of the guarantee involves Tekpak paying interest on the entire down-payment, although only half of the down-payment has been released to Tekpak to cover costs (the other half being held as collateral).

### 4.4. Developing an SME-friendly business environment

SMEs interviewed also elaborated on their belief that Europe has created a business and innovation environment that is skewed towards large enterprises and universities.





Zeeko explained how it has seen little of the public funding provided for projects in which it has collaborated with universities. Furthermore, Zeeko argued how countries like Japan offer a different “industrial respect” to its SMEs. As a result, Zeeko has entered into partnerships with the Department of Mechanical Engineering at Chubu University, Japan. Furthermore, Zeeko’s management are considering relocating to Japan, as they believe that the country offers a better and more supportive business environment than the UK.

*“The problem of working with a British university is that you are expected to finance any research. You are expected to finance that research 3 or 4 times, and the research never seems to finish.” – Zeeko*

Should Zeeko choose to move to Japan, Europe may be losing a small company, but it would also be losing a flagship company that supplies NASA and ESO, and a company that has grown from 4 to 85 employees in the space of 13 years. The loss of such innovative, European SMEs is a concern but is representative of the perception that many of Europe’s international competitors offer SMEs preferable business environments.

In addition, evopro explained how public procurement favoured large companies, and as a result, SMEs and mid-

*“The majority of Hungarian companies do not understand the nature of public procurement, i.e. the need to network and build appropriate partnerships”. – evopro*

caps are suffering from high failure rates in responding to public sector tenders, suggesting that SMEs and mid-caps are ill-equipped for breaking into the “inner circle” for publicly procured projects.

Finally, interviewees identified how there is a clear need to ease SMEs’ access to demonstrators, like CeNTI, which provide facilities for industrialising and validating business innovations at affordable rates.

#### 4.5. Adjusting to changing employment demand

Some see advances in manufacturing as a threat to jobs in Europe. However, manufacturing’s increasingly competitive

*Factory floors today often seem deserted, whereas the office blocks nearby are full of designers, IT specialists, accountants, logistic experts, marketing staff, customer-relations managers, cooks and cleaners, all of whom in various ways contribute to the factory. – The Economist*

environment is encouraging European companies to integrate advanced processes into their operations for: reducing operating and capital costs; improving product quality and consistency; increasing production output rates; increasing manufacturing flexibility; reducing waste and pollution; and

saving space in high value manufacturing areas<sup>8</sup>. In addition, and in spite of many advanced processes being jobs-free or jobs-light, it must be noted that behind these processes is a huge supply chain generating jobs and socio-economic benefits<sup>35</sup>.

Consequently, Europe must adapt its labour supply to accommodate manufacturing’s changing demand for employment, which is shifting towards hiring more highly skilled employees to control the production process with fewer moderately skilled operatives working on the production line<sup>36</sup>.

*“We have a saying at this firm: Don’t emigrate, automate!”  
– ATS Automation*

This changing demand for employment is tied to the introduction of new technologies in products and processes, which often give rise to the need for skills in digital techniques, computing, numeracy, problem solving, analytical thinking, risk analysis, and understanding methodologies (e.g. customisation and design-for-automation).

Interviewees highlighted how policy initiatives and funding for skills development should take into account the growing need for skills at the interface of technologies. For instance, in the case of additive manufacturing, there is a clear need for employees to have an understanding of laser technologies and printing techniques. In addition, interviewees highlighted the need to enthuse the workers of tomorrow to pursue a career in advanced manufacturing, whether by increasing the availability of apprenticeships or bringing advanced manufacturing processes into the classroom.

*“The academic background of many personnel is informatics. But it is normally best to have skills in the competences in which Materialise specialise, whether printing, software or medicine. Mechanical engineers are also needed to manage projects in a broader sense.” – Materialise*

Of the companies interviewed, there was little evidence of skill shortages as most companies were located in close proximity to large, skilled labour pools. For instance, Clifton benefits from its location in Tartu, a city of 100,000 inhabitants, of which approximately half are students. This skilled labour pool has enabled Clifton to hire the physicists and chemists it needs to develop and industrialise its GaAS technology. Similarly, CeNTI has drawn on the labour pool provided by its shareholders (including the universities of Aveiro, Minho and Porto) to have the necessary array of skill-sets in technical and mechanical engineering, chemistry, physics, materials science and polymers.



## 5. Policy recommendations

On the basis of the interviews conducted, policy areas that require further investigation for developing a business environment conducive to NME processes include: access to finance for innovative SMEs and mid-caps; client awareness of advanced processes; and access to highly skilled labour that is relevant to advanced manufacturing.

**Improve access to finance for innovative SMEs and mid-caps.** As the implementation of the revision of the Capital Requirements Directive places a greater squeeze on SMEs' ability to obtain credit, the EU must act to make-up for the shortfall of credit available to innovative SMEs and mid-caps.

In order to increase SME and mid-cap awareness of the existing financial support programmes that seek to fill this

*“Sometimes you find a deprived group that receives an unreal amount of support because it would otherwise sink without trace..I think SMEs are like this...We need to tip the playing field in their favour”.* – **Zeeko**

financing void, the EC published a practical guide to EU funding opportunities in research and innovation<sup>37</sup>. Nevertheless, there is still a clear need for both European Institutions and commercial banks to better inform SMEs and mid-caps about programmes that broaden their access to finance

opportunities, as a lack of knowledge leaves financial resources unemployed.

Therefore, with banks' increased capital requirements, it is expected that the EU will need to scale-up its financial support to innovative SMEs and mid-caps. This may be achieved by replicating the guarantee instruments used by the Risk Sharing Finance Facility (RSFF) and/or the Risk Sharing Instrument for Innovative Research oriented SMEs & Small Mid-Caps (RSI). In addition, the EU ought to consider formulating a communication strategy that increases the SMEs and mid-caps' awareness of EU funding opportunities in research and innovation, as most small and medium-sized businesses do not have sufficient resources for identifying appropriate EU programmes.

Improve prospective client awareness of NME processes. It is also believed that the public sector has a key role to play in

*“I think the main change has to come from the customer side, as many of them have an old-fashioned understanding of the relationship between a customer and a supplier.”* – **ATS Automation**

changing the prevailing cultural mindset towards the client-supplier relationship. Sedlak elaborated on this point by stating that Europe needs to place greater emphasis on clients and suppliers developing bi-lateral partnerships that can generate positive results for both

companies, e.g. reduced cost and risk by designing-to-automate.

Materialise also explained how there seems to be a networking gap in Additive Manufacturing, as Europe's existing platform (SASAM<sup>3</sup>) seeks to integrate and coordinate standardisation activities within the European Additive Manufacturing community but somewhat overlooks the need for the industry to achieve client buy-in. Furthermore, existing awareness activities do little to convince clients to engage early with suppliers, in order to formulate mutually beneficial partnerships that are capable of designing for advanced manufacturability.

Thus, the EU ought to investigate how it can act as a facilitator, supporting awareness raising programmes for advanced manufacturing processes. In addition, it is suggested that these awareness raising activities use case studies that emphasise the win-win situations achieved by clients engaging suppliers early in the design process and forging partnerships.

**Improve access to highly skilled labour that is relevant to advanced manufacturing.** By definition, advanced manufacturing is knowledge intensive and requires a high share of its employees to have received a tertiary education. Thus, for European manufacturers to make the transition to advanced manufacturing, the continent should assess how it can develop an appropriately skilled labour force that is able to implement, monitor and control NME processes.

More specifically, Europe ought to identify actions that will:

- Map clear career paths in advanced manufacturing, encouraging the skilled labour of tomorrow to pursue a career in manufacturing;
- Tackle the growing supply issues in the field of engineering, particularly in the areas of chemical, electrical, electronic, mechanical and process engineering;
- Increase access to initial vocational education and training, e.g. through apprenticeships; and
- Upskill workers, by encouraging them to engage in Continuing Professional Development schemes.

Should Europe be able to identify appropriate actions, innovative SMEs and mid-caps would be equipped with staff capable of driving innovation and growth through businesses' adoption of advanced manufacturing processes.

<sup>3</sup> Standardization in Additive Manufacturing (SASAM)



# 6. Appendix

## 6.1. Interviews

| Company name           | Interviewee          | Position                    |
|------------------------|----------------------|-----------------------------|
| Materialise            | Dr. Tom Craeghs      | Research Project Manager    |
| ATS Automation         | Alexander Sedlak     | Technical Marketing Manager |
| evopro group           | Balázs Bodnár        | Managing Director           |
| Tekpak Automation Ltd. | John Kehoe           | Managing Director           |
| CDA GmbH               | Dr. Nicolaus Hettler | Managing Director           |
| kringlan composites    | Dr. Niccolò Pini     | Chief Executive Officer     |
| Primoceler             | Ville Hevonkorpi     | Managing Director           |
|                        | Antti Peltonen       | Sales Manager               |
| CenNTI                 | Ana Ribeiro          | Business Developer          |
| Clifton                | Jaak Anton           | Chief Executive Officer     |
| Zeeko Ltd.             | Richard Freeman      | Managing Director           |

## 6.2. Websites

|                       |                                                                                                                                             |
|-----------------------|---------------------------------------------------------------------------------------------------------------------------------------------|
| Materialise           | <a href="http://www.materialise.com/">http://www.materialise.com/</a>                                                                       |
| ATS Automation        | <a href="http://www.atsautomation.com/">http://www.atsautomation.com/</a>                                                                   |
| evopro group          | <a href="http://www.evopro-group.com/">http://www.evopro-group.com/</a>                                                                     |
| Tekpak Automation Ltd | <a href="http://www.tekpakautomation.com/">http://www.tekpakautomation.com/</a>                                                             |
| CDA GmbH              | <a href="http://www.cda.de/en/Home__241/">http://www.cda.de/en/Home__241/</a>                                                               |
| kringlan composites   | <a href="http://www.kringlan.ch/">http://www.kringlan.ch/</a>                                                                               |
| Primoceler            | <a href="http://www.primoceler.com/">http://www.primoceler.com/</a>                                                                         |
| CeNTI                 | <a href="http://www.centi.pt/">http://www.centi.pt/</a>                                                                                     |
| Clifton               | <a href="http://www.clifton.ee/about-us">http://www.clifton.ee/about-us</a>                                                                 |
| Zeeko Ltd.            | <a href="http://www.zeeko.co.uk/site/tiki-index.php?page=HomePagePublic">http://www.zeeko.co.uk/site/tiki-index.php?page=HomePagePublic</a> |

## 6.3. References

- <sup>1</sup> High Level Working Group on Key Enabling Technologies (2010) Thematic Report by the Working Team on Advanced Manufacturing Systems.
- <sup>2</sup> Kaplan, R.S. (1990) Measures for Manufacturing Excellence, Harvard Business School Press, Boston, Massachusetts.
- <sup>3</sup> High Level Working Group on *Manufuture* (2006) *Manufuture: Strategic Research Agenda – Assuring the Future of Manufacturing in Europe*.
- <sup>4</sup> European Commission (2009) Fourth Status Report on European Technology Platforms: Harvesting The Potential.
- <sup>5</sup> Sethi, A.K. & Sethi, S.P. (1990) Flexibility in Manufacturing : A Survey, The International Journal of Flexible Manufacturing Systems, 2 , pp.289-328.



- <sup>6</sup> Westkämpfer, E. et al. (2011) Next Generation Manufacturing: Manufacturing 2030, available at: <http://www.manutex.eu/publications/Manufuture.pdf>. [Accessed on 20 June 2013].
- <sup>7</sup> Kaufui, V.W. & Hernandez, A. (2012) A Review of Additive Manufacturing, ISRN Mechanical Engineering, Volume 2012.
- <sup>8</sup> Mitchell, J., Clarke, C., Shaffer, J., Su, J., Chen, P., Kuroda, S., Smith, S., Savaris, B. (2012) Global industrial automation: The next growth phase, Credit Suisse Equity Research, Connections Series, 14 August 2012.
- <sup>9</sup> Kalpakjian, S. & Schmid, S. (2008) Automation in Manufacturing, in Manufacturing Processes for Engineering Materials, 5th Edition, available at: [http://www3.nd.edu/~manufact/MPEM%20pdf\\_files/Ch14.pdf](http://www3.nd.edu/~manufact/MPEM%20pdf_files/Ch14.pdf). [Accessed on 20 June 2013].
- <sup>10</sup> Brussel, H.V., van Eijk, J., Spaan, H. & Brinksmeier, E. (2008) Precision Engineering: The European Way.
- <sup>11</sup> Taniguchi, M. (1983) Current status in, and future trend of, Ultraprecision Machining and Ultrafine materials processing, Annals of the CIRP, Vol.32(2), pp.573-582, available at: <http://www.ielm.ust.hk/dfaculty/ajay/courses/ieem575/lecs/intro/lecIntro.html>, [Accessed on 26 June 2013].
- <sup>12</sup> Venkatesh, V.C. & Izman, S. (2007) Precision Engineering, Tata McGraw-Hill Publishing Company Limited, New Delhi.
- <sup>13</sup> Geerts, F. (2011) Why and how to keep European Advanced Manufacturing globally competitive? Manufuture 2011 conference, 24-25 October 2011, Wroclaw, available at: <http://www.manufuture2011.eu/presentations/Ps2-HAV%20in%20Global%20Manufacturing/Filip%20Geerts/Filip%20Geerts.pdf>. [Accessed on 20 June 2013].
- <sup>14</sup> Engineering and Machinery Alliance (2010) Automation Study Highlights.
- <sup>15</sup> Huang, S.H., Liu, P., Mokasdar, A. & Hou, L. (2012) Additive manufacturing and its societal impact: a literature review, the International Journal of Advanced Manufacturing Technology, October 2012.
- <sup>16</sup> The Ad-hoc Industrial Advisory Group (2010) Factories Of The Future PPP Strategic Multi-Annual Roadmap.
- <sup>17</sup> Materialise, The RBM Noor, Tested to the Bone, Before it even Existed! Available at: <http://www.materialise.com/cases/the-rbm-noor-tested-to-the-bone-before-it-even-existed>. [Accessed on 21 June 2013].
- <sup>18</sup> ATS Automation (2012) Annual Report 2012.
- <sup>19</sup> evopro group (2013) Another Assignment from Mercedes in Berlin, available at: <http://www.evopro-group.com/nodes/view/678>. [Accessed on 21 June 2013].
- <sup>20</sup> Tekpak (2013) About Tekpak UK & Ireland: Our Purpose, available at: <http://www.tekpackautomation.com/about-us/>. [Accessed on 21 June 2013].
- <sup>21</sup> CDA GmbH (2013) Technologies: Printed electronics, available at: [http://www.cda.de/en/Printed-Electronics\\_\\_268/](http://www.cda.de/en/Printed-Electronics__268/). [Accessed on 29 May 2013].
- <sup>22</sup> kringlan composites (2013) kringlan composites
- <sup>23</sup> Hevonkorpi, V. (2012) Microfabrication and welding of transparent materials by laser micro processing, Primoceler, available at: [http://www.vtt.fi/files/sites/eemeli9/08\\_hevonkorpi\\_primoceler\\_eemeli9.pdf](http://www.vtt.fi/files/sites/eemeli9/08_hevonkorpi_primoceler_eemeli9.pdf). [Accessed on 3 June 2013].
- <sup>24</sup> CeNTI (2013) Presentation on CeNTI, June 2013.
- <sup>25</sup> Clifton (2013) GaAS Liquid Phase Epitaxy, available at: <http://www.clifton.ee/technology>. [Accessed on 4 June 2013].
- <sup>26</sup> Zeeko Ltd. (2012) Zeeko Today.
- <sup>27</sup> Zilinski, P. (2013) Why Did GE Aviation Acquire Morris Technologies? An interview with Randy Kappesser, composites technology leader with GE Aviation, Modern Machine Shop, available at: <http://www.mmsonline.com/columns/why-did-ge-aviation-acquire-morris-technologies>. [Accessed on 23 June 2013].
- <sup>28</sup> Vanraen, W. (2010) A more Productive Creative Europe...e.g. through Additive Manufacturing, Materialise.
- <sup>29</sup> Wohlers Associates (2013) Wohlers Report 2013: Additive Manufacturing and 3D Printing State of the Industry – Annual Worldwide Progress Report.
- <sup>30</sup> Gerwin, D. (1993) Manufacturing flexibility: a strategic perspective, Management Science, Vol.39, No.4, pp.395-410.
- <sup>31</sup> Mandelbaum, M. (1978) Flexibility in Decision Making: An Exploration and Unification, Ph.D. Thesis, Department of Industrial Engineering, University of Toronto, Canada.
- <sup>32</sup> Materialise (2013) Materialise Releases New Version of the Mimics Innovation Suite, Press Release, 15 March 2013, available at: <http://www.materialise.com/press/materialise-releases-new-version-of-the-mimics-innovation-suite>. [Accessed on 24 June 2013].
- <sup>33</sup> Sedlak, A. (2007) How to Effectively Partner With An Automation Company, European Medical Device Technology, 1 November 2007



- <sup>34</sup> ATS Automation (2013) Creating Value: Automated Solutions for Manufacturing Excellence.
- <sup>35</sup> The Economist (2012) Back to making stuff : Manufacturing still matters, but the jobs are changing, 21 April 2012.
- <sup>36</sup> Davis, C., Hogarth, T., Gambin, L., Breuer, Z. & Garrett, R. (2012) Sector Skills Insights: Advanced Manufacturing, Evidence Report 48, July 2012, UK Commission for Employment and Skills.
- <sup>37</sup> European Commission (2011) New Practical Guide to EU Funding Opportunities for Research and Innovation.