



---

On-site workshop

# eInvoicing Implementation Workshop

---

3 October 2018, Stockholm, Sweden

Link to countrypage for the workshop:

<https://ec.europa.eu/cefdigital/wiki/display/EINVCOMMUNITY/Sweden+-+Implementation+workshop>

 #ConnectingEurope

# Today's speakers

## **Christian Rasmussen**

Christian is an experienced eProcurement Expert specialized in the execution of large scale ICT projects with past experience from the Nordic region including Denmark, Norway and Sweden. Christian has also been involved in the past EU-funded large scale pilots PEPPOL.eu and eSENS.eu as Work packager leader including focus on new eProcurement and eDelivery development.

## **Martin Forsberg**

Martin Forsberg works as an expert in the area of electronic business, customs and financial processes. Martin was involved in the PEPPOL and eSENS Large Scale Pilots. He is active in standardization committees such as CEN TC434 and OASIS UBL.

---

# Highlights of the workshop

## DURING



Ask questions

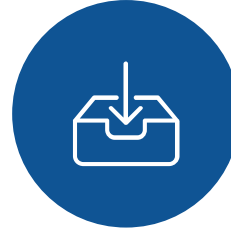

Download  
other  
presentations  
at CEF Digital

## AFTER



Download our other  
webinar recordings



Interact with our  
online community

---

## Objectives of this workshop

Participants will learn about:

- CEF eInvoicing and our services
- The **European norm** and the **Directive 2014/55/EU** on electronic invoicing in public procurement
- **The Swedish implementation**
- Presentation of the European norm and related **specifications**
- The **XML formats** used with the European standard and the PEPPOL BIS BILLING 3
- **Funding opportunities with CEF**

## Audience for this workshop

- Members of NEA

**Who are you?**



---

# CEF eInvoicing – Our services and how to get started

---

**Christian Vindinge Rasmussen**  
DIGIT



# What is CEF eInvoicing

# What is CEF?



**TRANSPORT**  
€26.25bn

**TELECOM**

**Digital Service Infrastructures**  
€970 M \*

**Broadband**  
€170 M

**ENERGY**  
€5.85bn

## HOW IS IT REGULATED?

### CEF Regulation

The Connecting Europe Facility (CEF) is a regulation that defines how the Commission can finance support for the establishment of trans-European networks to reinforce an interconnected Europe.

### CEF Telecom Guidelines

The CEF Telecom guidelines cover the specific objectives and priorities as well as eligibility criteria for funding of broadband networks and Digital Service Infrastructures (DSIs).

### CEF Work Programmes

Translates the CEF Telecom Guidelines in general objectives and actions planned on a yearly basis.

\* - 100 M Juncker Package



# What are Digital Service Infrastructures?

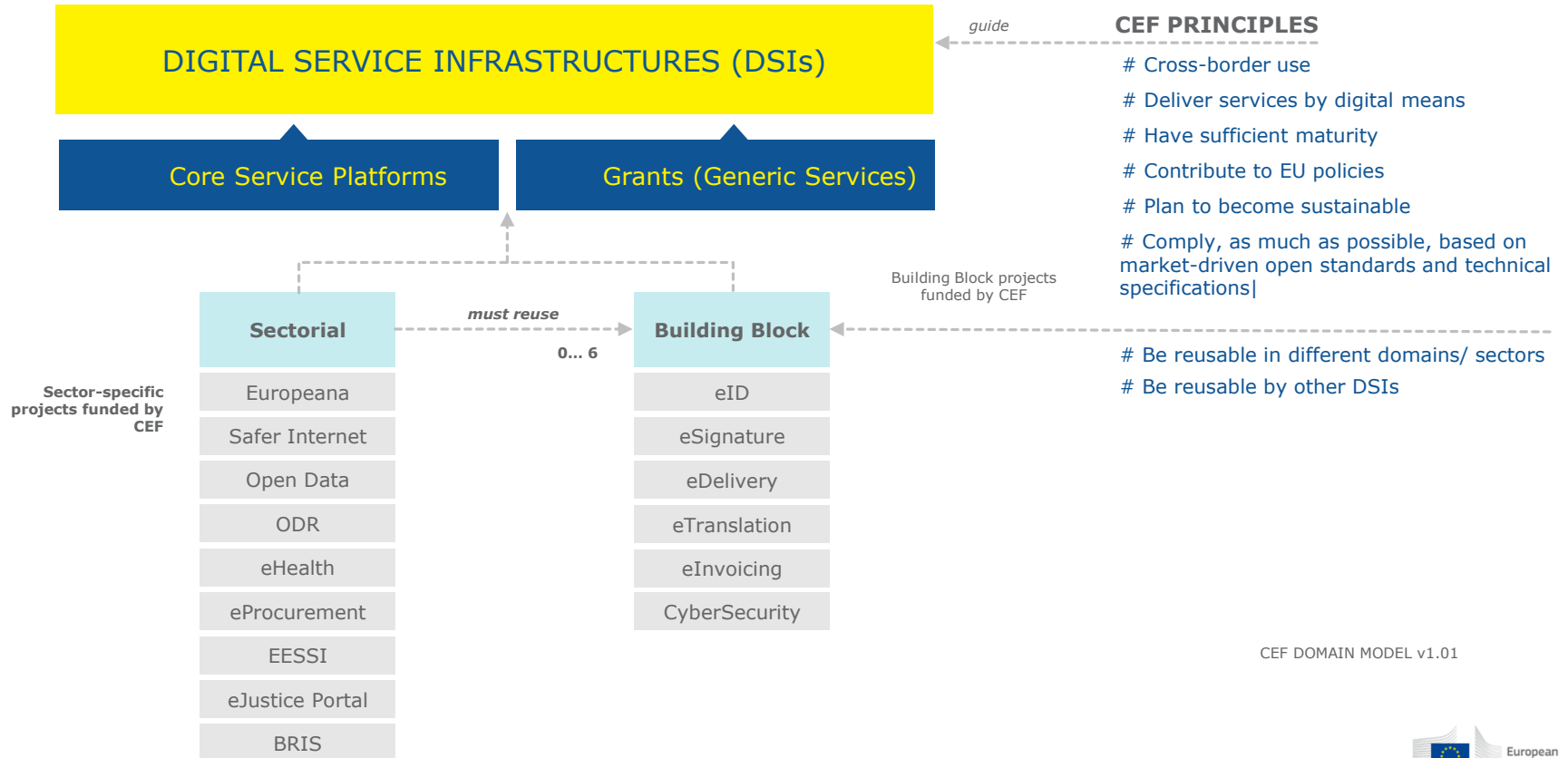

(\* ) A Building Block is a package of technical specifications, services and sample software that can be reused in different policy domains:

# The 'Big Picture'

Funding for the  
EUROPEAN COMMISSION



eJustice

ODR

Open Data

BRIS

EESSI, etc.

## CORE SERVICE PLATFORMS

Services offered by the  
European Commission



**IDENTIFY**  
with eID



**SIGN**  
with eSignature



**INVOICE**  
with eInvoicing



**EXCHANGE**  
with eDelivery



**TRANSLATE**  
with eTranslation

Funding for the  
MEMBER STATES

## GRANTS

Projects in the Member  
States



Typically 'deployment' projects at national level (up to  
75% of eligible cost)



European  
Commission



---

# CEF Digital

---



CEF Digital  
Connecting Europe

MENU ▾COMMUNITY

---

CEF Digital Home

## eInvoicing

Helping public entities adopt the European standard on electronic invoicing.

---

### Learn about eInvoicing

Everything you need to know about eInvoicing

+

---

### Use eInvoicing

For public entities getting started with eInvoicing in public procurement

+

---

### Make your solution conformant

For solution & service providers looking to adopt the European standard on eInvoicing

+

---

### Join the community

Join one or more communities or help promote the uptake of eInvoicing

+

---

### Featured

Call for [grants](#) opens 28 June 2017

---





### Communities

[eInvoicing User Community](#) 

[European Multi-Stakeholder Forum on eInvoicing](#) 

---

### Quick Links

-  [Contact support](#)
-  [All eInvoicing Services](#)
-  [Readiness Checker](#)
-  [Monitoring dashboard](#)

---

### Latest

[CEN Publishes eInvoicing Semantic Data Model](#)

The Innovation and Networks Executive Agency (INEA) launches grants of up to €10 million to support electronic invoicing (eInvoicing) in Europe.

# eInvoicing Readiness Checker

The screenshot shows the homepage of the eInvoicing Readiness Checker. At the top, there is a header with the CEF Digital logo and the text 'European Commission > CEF Digital > eInvoicing > Readiness Checker'. A search bar is located in the top right corner. Below the header, the main content area is divided into three columns: 'About', 'Public Entities', and 'Solution & Service Providers'. The 'About' section contains text explaining the checker's purpose and a 'Download User Manual' button. The 'Public Entities' section features a building icon, a question 'Is your administration ready for eInvoicing?', and a 'Take the test' button. The 'Solution & Service Providers' section features a person icon, a question 'Can you offer eInvoicing solutions that Public Entities need?', and a 'Create a profile' button. At the bottom, there is a dark navigation bar with three icons and labels: 'Public Entities', 'Solution & Service Providers', and 'Countries'. The footer includes the European Commission logo and name.

Support [en](#) English

European Commission > CEF Digital > eInvoicing > Readiness Checker

## eInvoicing Readiness Checker

[Home](#) [Take the test](#) [Find a Public Entity](#) [Find a Solution & Service Provider](#) [Countries](#) [Login to the Readiness Checker](#)

### About

The eInvoicing Readiness Checker helps Public Entities assess their readiness status in accordance to the compliance of the EU Directive 2014/55/EU and enables Solution & Service Providers to present their eInvoicing software products and services.

[Download User Manual](#)

### Public Entities

Is your administration ready for eInvoicing?

[Take the test](#)

### Solution & Service Providers

Can you offer eInvoicing solutions that Public Entities need?

[Create a profile](#)

[Public Entities](#) [Solution & Service Providers](#) [Countries](#)

European Commission

# eInvoicing User Community

CEF DIGITAL

## eINVOICING USER COMMUNITY

### FORUM

The CEF eInvoicing User Community Forums are a great place to post questions and share comments with fellow eInvoicing users, implementors and Service and Solution providers. Discuss a variety of topics, from implementing Directive 2014/55/EU to promoting the adoption of eInvoicing solutions.

Topic	Author	Creation date	
Implementations of the new European Norm in the Member States - What is your plans?	@Christian Vindinge RASMUSSEN	31-05-2017	🗨️ 3 🍊 2
Webinar # 1: CEF eInvoicing - What's in it for you?	@Ines COSTA	📅 08 May 2017	
CEF eInvoicing Implementation Workshops - register now!	@Ines COSTA	📅 02 May 2017	🗨️ 2
Standard Definitions for Techniques of Supply Chain Finance	@José VICENTE	📅 18 Apr 2017	
ZUGFeRD Developers meet in May 2017	@Stefan ENGEL-FLECHSIG	📅 20 Mar 2017	🗨️ 1 🍊 3

Prev 1 2 Next

[Visit Forum](#)

[Create new topic](#)

### CONTRIBUTE

The objective of the **Contribute** section in the CEF eInvoicing User Community is to allow eInvoicing stakeholders to participate in ongoing activities launched by CEF eInvoicing by providing information, feedback, comments or taking action in a different range of initiatives.

Title	Excerpt	Status	Deadline	
2016 eInvoicing Country Sheets	As national representatives you are asked to verify the eInvoicing situation in your country.	COMPLETED	📅 31 Dec 2016	🗨️ 4
2017 State of Play of B2G eInvoicing: Participate in an online survey	Participate in an online survey to help us to obtain input on the state of play of your country's B2G eInvoicing in public procurement	OPEN	Ongoing	
eInvoicing Pioneer Group	Are you active in eInvoicing from the public or private sector side? Join this group to provide feedback to the EC on eInvoicing matters and to drive activities to support the launch of the <a href="#">European Standard on eInvoicing</a> and compliance with <a href="#">Directive 2014/55/EU</a> .	OPEN	Ongoing	🗨️ 1 🍊 6
2017 State of Play of B2G eInvoicing: Bring your contribution!	Define what questions should be address in the state of play of B2G eInvoicing in public procurement study, and who should be invited to answer the questions.	COMPLETED	📅 28 Feb 2017	🗨️ 13 🍊 4
The future mandate of the forum	As the current European Multi-Stakeholder Forum on eInvoicing (EMSFEI) mandate is coming to an end, we warmly invite you to play an active role in the definition of the future mandate of this forum.	COMPLETED	📅 15 Feb 2017	🗨️ 1 🍊 1

### About the community

The eInvoicing User Community space enables stakeholders involved and interested in cross-border eInvoicing, to discuss eInvoicing in the EU public and private sectors. The space is also used for co-creative activities with the Advisory Group and Early Adopters of the upcoming eInvoicing Match-Making Website, which is designed to help public administrations implement electronic eInvoicing, as per the requirements of Directive 2014/55/EU.

#### Your space moderators



---

# CEF eInvoicing Trainings



## Implementation workshops

- Typically at least one full or one half-day workshop;
- Possibly in combination with **bilateral meetings** b/w EC and MS;
- So far workshops in **Cyprus, Finland, Estonia, Poland, Greece, Croatia, Malta, Ireland**;
- Planned workshops in Sweden, Czech Rep., Germany, Lithuania, Portugal
- **Apply** here: [CEF-BUILDING-BLOCKS@ec.europa.eu](mailto:CEF-BUILDING-BLOCKS@ec.europa.eu)



## Remote trainings

- Live sessions on a focused eInvoicing topic for a specialised target audience;
- 1-3 hour-long sessions provided on-line;
- Focused training sessions on key areas derived from the on-site workshops.





## Webinars

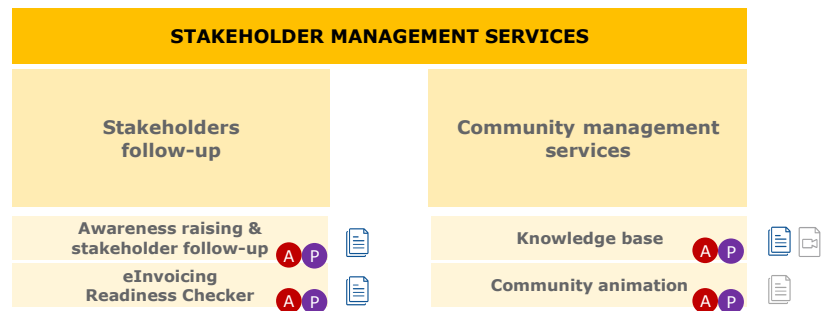
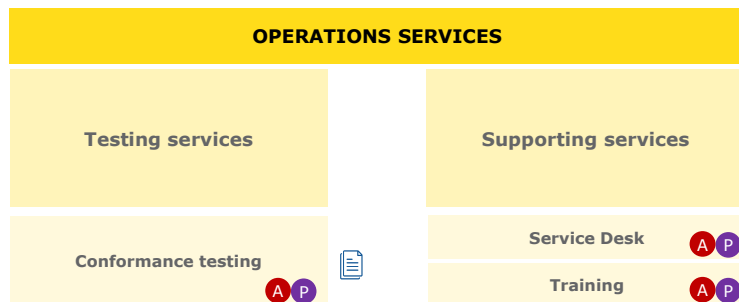

- **About 1 hour-long sessions with core elements from on-site and remote trainings to gain expertise in key areas.**

# CEF eInvoicing Service offering



**AUDIENCE**

-  Public Administrations
-  Solution Providers

-  Available
-  Coming soon

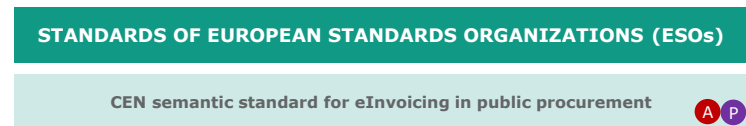

## Service offering Description (SoD)

All services are described in an SoD describing its purpose, the users for which it is for, its benefits and the process to use it



## Service Level Arrangements (SLA)

Documents that describe Service Level Targets to be reached when delivering Building Block Services.



## eLearning, videos, success stories

Some services feature multimedia such as eLearnings, instructional videos or success stories to help grasp what the service is about

## CEF Digital platform

CEF eInvoicing service offering, and more about the building block, can be found online

[CEF Digital >](#)



---

## More Webinars Related to the Standard and the Directive

- September** ● Webinar #3 The European norm and its content (eInvoicing Directive)
- October** ● Webinar #4 Infrastructure based on CEF eDelivery DSI
- November** ● Webinar #5 eInvoicing from a user's perspective (incl. ordering & payments)
- December** ● Webinar #6 Examples of Early Adopters of large scale eInvoicing
- January** ● Technical webinars  
Webinars #7, 8 & 9 Basic XML + XML Validation mechanisms + OASIS UBL 2.1 and UN/CEFACT CII D16B
- February** ●

---

## More Webinars Related to the Standard and the Directive

- June** ● CIUS (Core Invoice Usage Specifications)
- July** ● Latest policy updates on IPR
- October** ● **Learn from other countries' eInvoicing**
- November** ● TBD - Important highlights from the European standard part 1 – functional/business perspective
- December** ● TBD - Important highlights from the European standard part 2 – technical perspective
- TBD** ●



---

# Introduction to eInvoicing and the European standard

---

**Martin Forsberg**  
DIGIT

---

# Background

- Problems with **many standards**
- **Lack of normative contextualised standards** (only workshop agreements)
- **Different approaches and ambitions** in Member States to implementing eInvoicing and eProcurement
- The Directive on electronic invoicing in public procurement ([Directive 2014/55/EU](#)) was developed, setting a **minimum requirement** for the public sector

## From the Directive

*The benefits of electronic invoicing are maximised when the generation, sending, transmission, reception and processing of an invoice can be fully automated.*

...

*A mere image file should not be considered to be an electronic invoice for the purpose of this Directive.*

---

# Requirements for the contracting authorities/entities

## From article 7

### ***Receipt and processing of electronic invoices***

*Member States shall ensure that contracting authorities and contracting entities **receive and process electronic invoices** which comply with the **European standard on electronic invoicing** whose reference has been published pursuant to Article 3(2) and with **any of the syntaxes on the list** published pursuant to Article 3(2).*

a list with a limited number of syntaxes which comply with the European standard on electronic invoicing

Semantic data model of the core elements of an electronic invoice

# Definitions

(1) **'electronic invoice'** means an invoice that has been issued, transmitted and received in a structured electronic format which allows for its automatic and electronic processing;

(2) **'core elements of an electronic invoice'** means a set of essential information components which an electronic invoice must contain in order to enable cross-border interoperability, including the necessary information to ensure legal compliance;

(3) **'semantic data model'** means a structured and logically interrelated set of terms and their meanings that specify the core elements of an electronic invoice;

(4) **'syntax'** means the machine readable language or dialect used to represent the data elements contained in an electronic invoice;

(5) **'syntax bindings'** means guidelines on how a semantic data model for an electronic invoice could be represented in the various syntaxes;

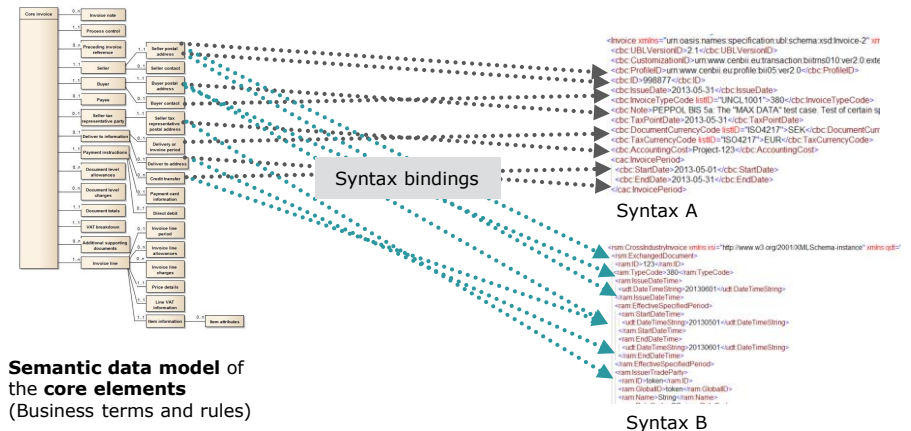
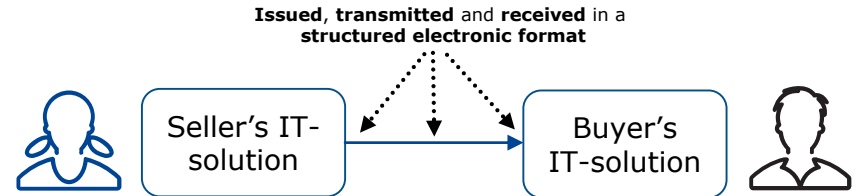



# **The development of the European standard on eInvoicing**

---

# Initiation of the standardisation

## From article 3

*The Commission shall request that the relevant **European standardisation organisation** draft a European standard for the semantic data model of the core elements of an electronic invoice (the 'European standard on electronic invoicing').*

...

*The Commission shall request that the relevant European standardisation organisation provide a list with a limited number of syntaxes which comply with the European standard on electronic invoicing, the appropriate syntax bindings and guidelines on transmission interoperability, in order to facilitate the use of such standard.*



# CEN/TC 434 was established

- CEN - European Committee for Standardisation
- The work started in a project committee (PC434) but was later changed into a technical committee (TC434)
- TC434 has over 100 committee members from 31 countries
- Participation in the work must go through the national standardisation committees.
- The committee is about to finalize all deliverables defined in the standardisation request

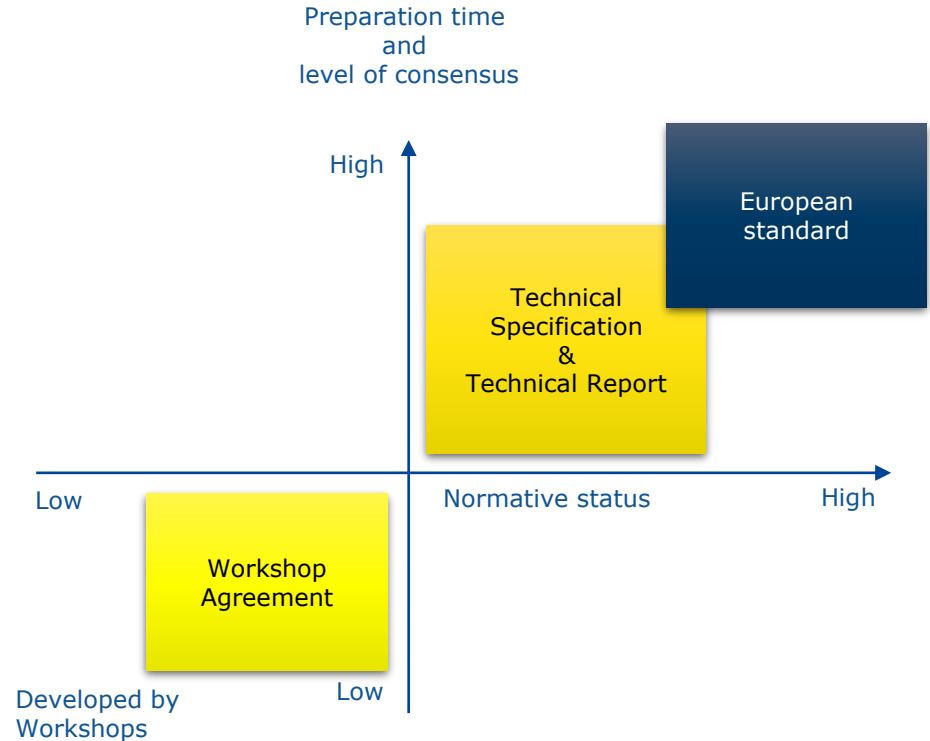

# Current status

Number	Title	Status
<b>EN 16931-1</b>	Semantic data model of the core elements of an electronic invoice	Approved!
<b>CEN/TS 16931-2</b>	List of syntaxes that comply with EN 16931-1	Approved!
<b>CEN/TS 16931-3-1</b>	Methodology for syntax bindings of the core elements of an electronic invoice	Approved!
<b>CEN/TS 16931-3-2</b>	Syntax binding for ISO/IEC 19845 (UBL2.1) invoice and credit note	Approved!
<b>CEN/TS 16931-3-3</b>	Syntax binding for UN/CEFACT XML Cross Industry Invoice D16B	Approved!
<b>CEN/TS 16931-3-4</b>	Syntax binding for UN/EDIFACT D16B	Approved!
<b>CEN/TR 16931-4</b>	Guidelines on interoperability of electronic invoices at the transmission level	Approved!
<b>CEN/TR 16931-5</b>	Guidelines on the use of sector or country extensions in conjunction with EN 16931-1, methodology to be applied in the real environment	Approved!
<b>CEN/TR 16931-6</b>	Result of the test of EN 16931-1 with respect to its practical application for an end user	Approved!



# **Introduction to key concepts of the standard**

EUROPEAN STANDARD  
NORME EUROPÉENNE  
EUROPÄISCHE NORM

FINAL DRAFT  
FprEN 16931-1

January 2017

ICS 35.240.20; 35.240.63

English Version

Electronic invoicing - Part 1: Semantic data model of the  
core elements of an electronic invoice

Facturation électronique - Partie 1: Modèle sémantique  
de données des éléments essentiels d'une facture  
électronique

Elektronische Rechnungsstellung - Teil 1:  
Semantisches Datenmodell der Kernelemente einer  
elektronischen Rechnung

This draft European Standard is submitted to CEN members for formal vote. It has been drawn up by the Technical Committee  
CEN/TC 434.

If this draft becomes a European Standard, CEN members are bound to comply with the CEN/CENELEC Internal Regulations  
which stipulate the conditions for giving this European Standard the status of a national standard without any alteration.

This draft European Standard was established by CEN in three official versions (English, French, German). A version in any other  
language made by translation under the responsibility of a CEN member into its own language and notified to the CEN-CENELEC  
Management Centre has the same status as the official versions.

CEN members are the national standards bodies of Austria, Belgium, Bulgaria, Croatia, Cyprus, Czech Republic, Denmark, Estonia,  
Finland, Former Yugoslav Republic of Macedonia, France, Germany, Greece, Hungary, Iceland, Ireland, Italy, Latvia, Lithuania,  
Luxembourg, Malta, Netherlands, Norway, Poland, Portugal, Romania, Serbia, Slovakia, Slovenia, Spain, Sweden, Switzerland,  
Turkey and United Kingdom.

Recipients of this draft are invited to submit, with their comments, notification of any relevant patent rights of which they are  
aware and to provide supporting documentation.

Warning: This document is not a European Standard. It is distributed for review and comments. It is subject to change without  
notice and shall not be referred to as a European Standard.



EUROPEAN COMMITTEE FOR STANDARDIZATION  
COMITÉ EUROPÉEN DE NORMALISATION  
EUROPÄISCHES KOMITEE FÜR NORMUNG

CEN-CENELEC Management Centre: Avenue Marnix 17, B-1000 Brussels

© 2017 CEN All rights of exploitation in any form and by any means reserved  
worldwide for CEN national Members.

Ref. No. FprEN 16931-1:2017 E

Section 1-3 - Scope, references, terms & definitions

Section 4 – The concept of a core invoice

Section 5 – Business process to support

Section 6 – The semantic model, rules and data types

Section 7 – Core Invoice Usage Specification (and  
compliance)

Annex A – Examples (Informative)

Annex B – Assessment of the EN towards the  
Standardization request (Informative)

Annex C – How does the EN meet legal  
requirements (Informative)

Annex D – BPMN symbols (informative)

# Areas covered by the standard

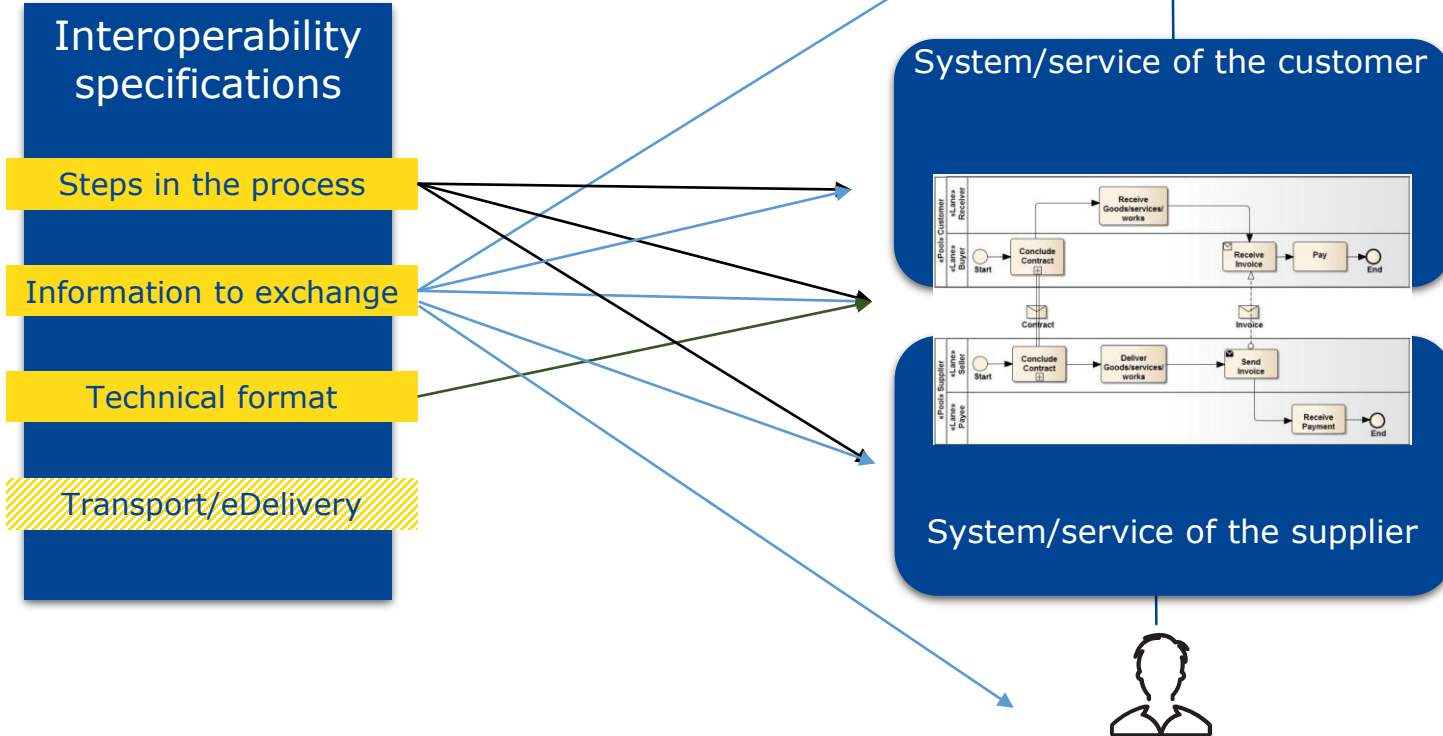

---

# Reasons for a core invoice

The European standard recognises the following reasons:

- Business environment is diverse – also the need for information exchange
- Invoices from different situations may potentially contain many information elements – a complete model becomes very large and complex
- Even if it would technically be possible to have a large model, it would be challenging and costly
- When different countries/industries use subset of large standards, interoperability is hampered and silo-implementations are created

# Common understanding

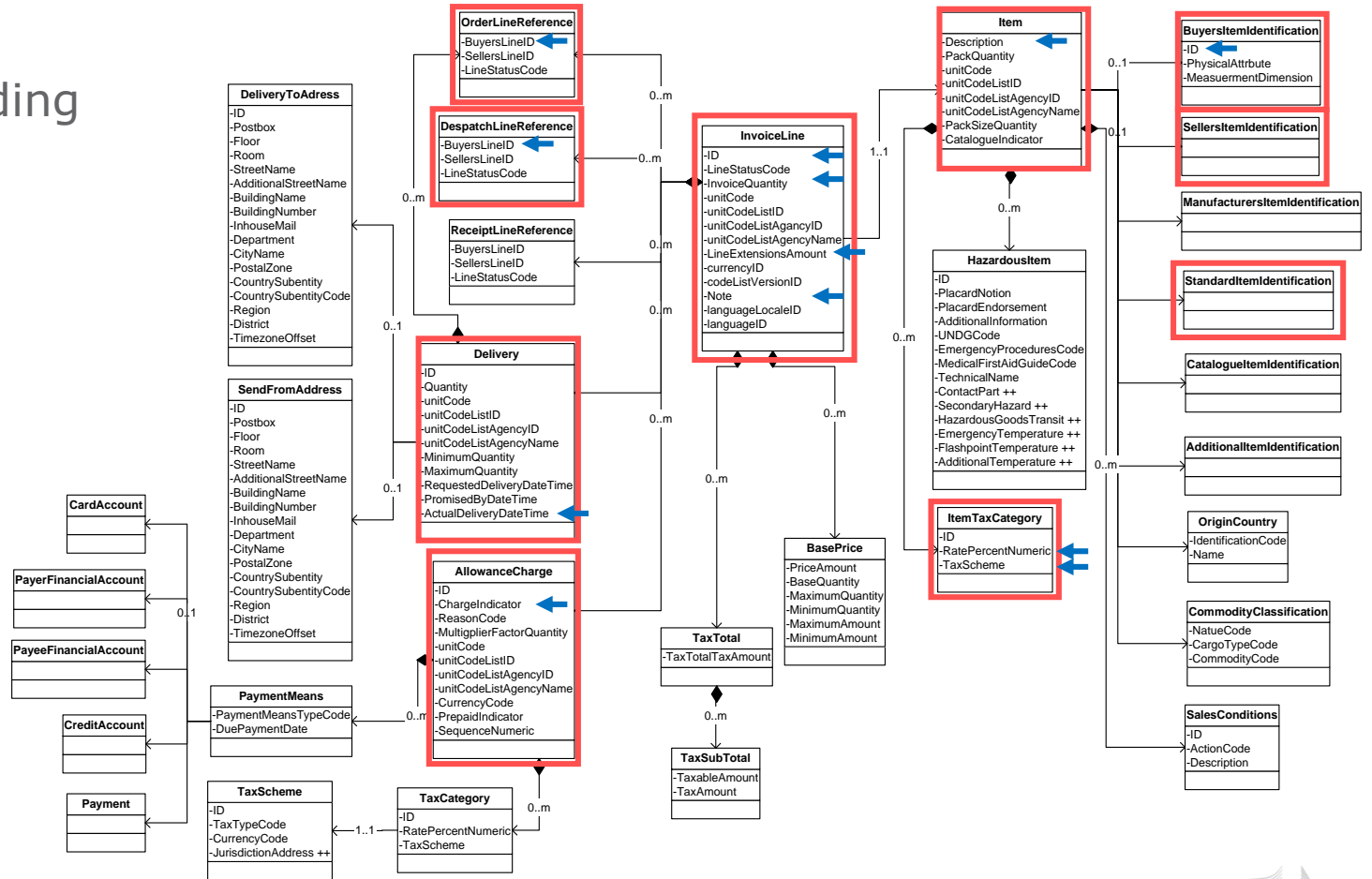

---

Core (minimum in common) or  
common subset (maximum in  
common)

### The subset approach

- The subset becomes the  
framework/outer boundaries

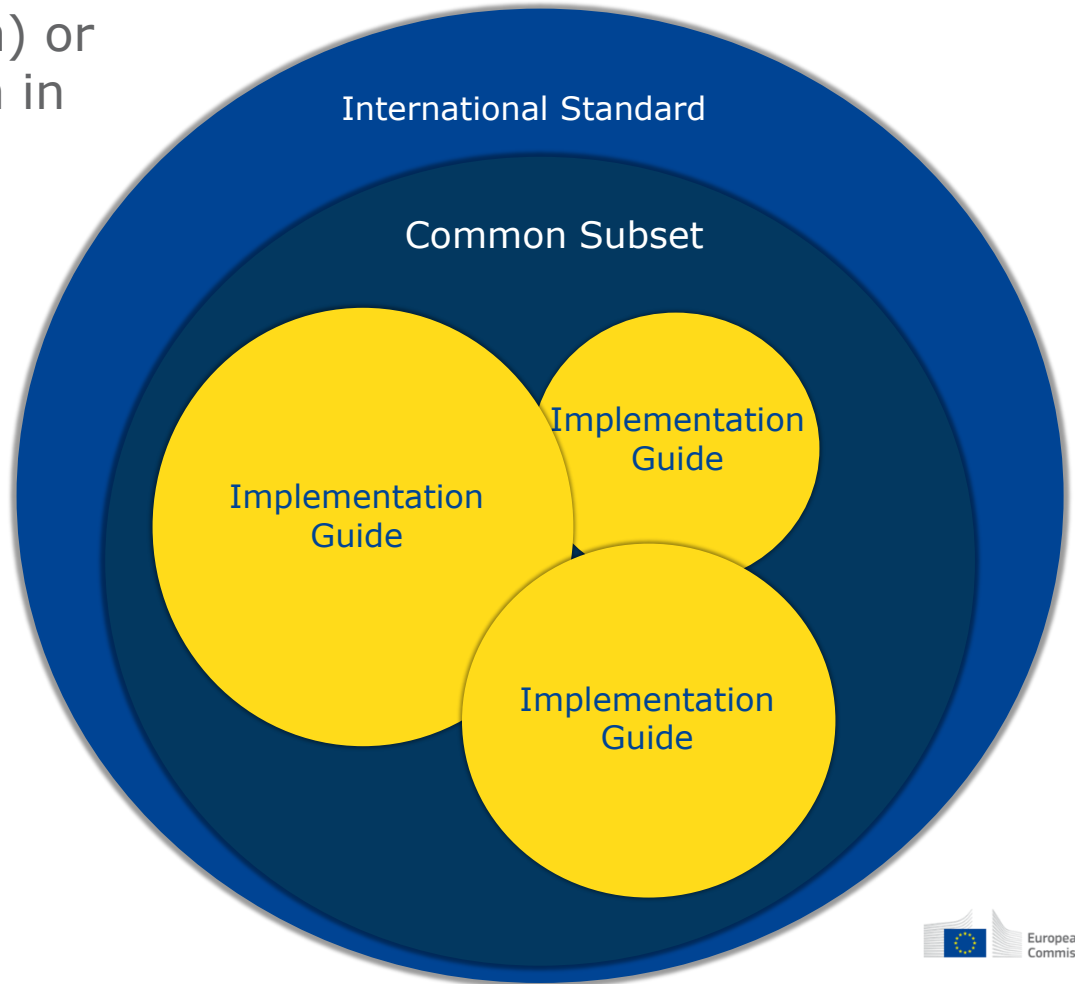



---

## Core – something in common

### **IMPORTANT**

An invoice which follows a CIUS  
MUST ALWAYS also be compliant  
towards the (non-restricted)  
norm.

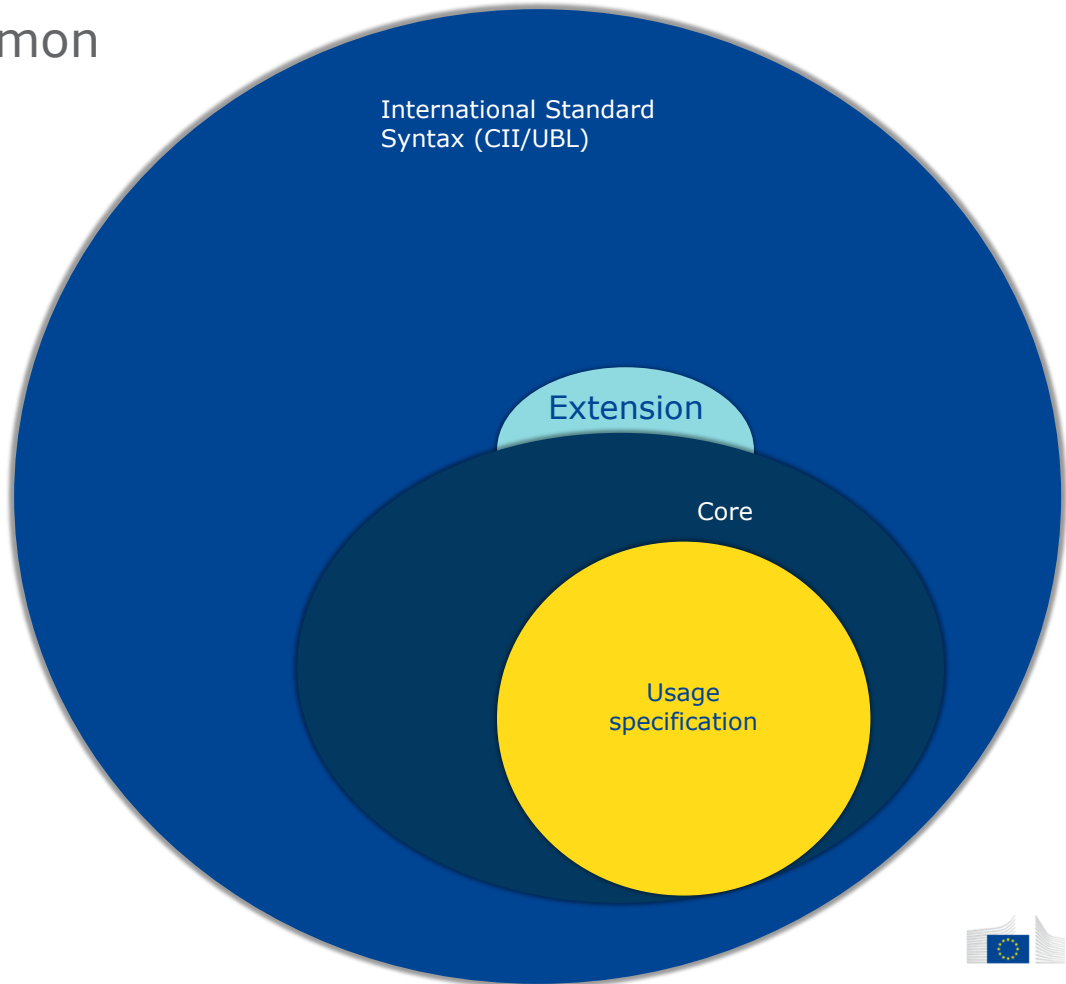

---

# The concept of a core invoice – How?

The norm identifies a few **guiding principles**:

- It should be easier to use than paper invoicing
- Standardised information elements makes processing more efficient (than paper invoices)
- It should be possible to use without prior consultation or bilateral agreements
- It should contain information to enable efficient and automatic processing
- Software should be able to present all information, and automatically process structured data
- Structured data should result in optimised business processes
- The core invoice model should not make assumptions on the method of creation, delivery or processing
- The core invoice model should not make assumptions on the syntax or transmission technology

---

# Requirement driven approach on defining the model

- Each business term in the model comes from one or more documented (and numbered) requirement
- The requirements give a good understanding of the background

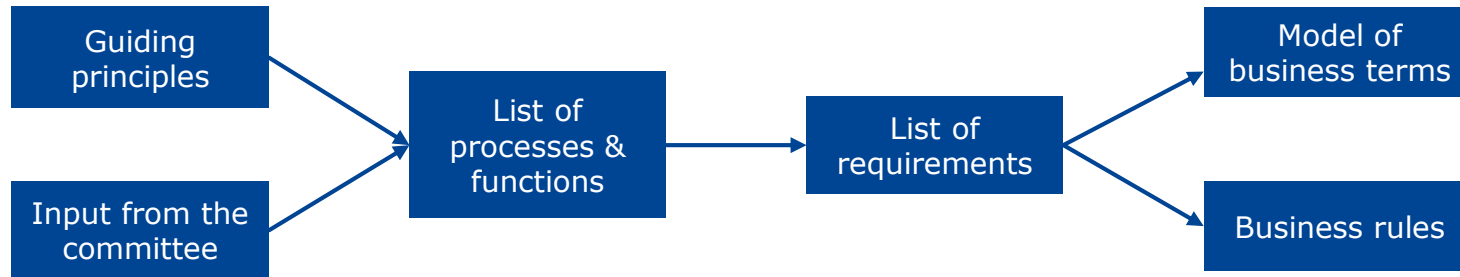

# Business processes to support

The invoice model contains information elements to support the following processes

- P1: Invoicing of deliveries of goods and services against purchase orders, based on a contract
- P2: Invoicing deliveries of goods and services based on a contract
- P3: Invoicing the delivery of an incidental purchase order
- P4: Pre-payment
- P5: Spot payment
- P6: Payment in advance of delivery
- P7: Invoices with references to a despatch advice
- P8: Invoices with references to a despatch advice and a receiving advice
- P9: Credit notes or invoices with negative amounts, issued for a variety of reasons including the return of empty packaging
- P10: Corrective invoicing (cancellation/correction of an invoice)
- P11: Partial and final invoicing
- P12: Self billing

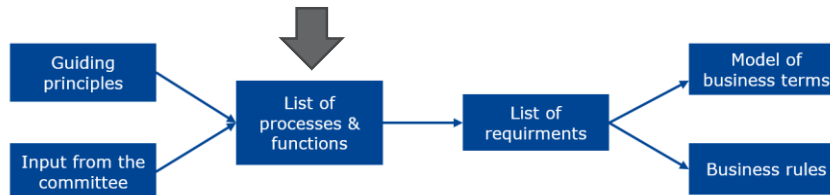

# Business requirements derived from the processes

- Based on the identified processes and listed invoice functions, requirements are defined
- Each requirement has an assigned identifier

- R5 information to trace to a single related purchase order from the document level (all processes, except P2 and P5);
- R6 information to trace to a single related purchase order line from the invoice line (all processes, except P2 and P5);
- R7 information to trace to a single contract and the underlying call for tenders from the document level (all processes, except P3 and P5);

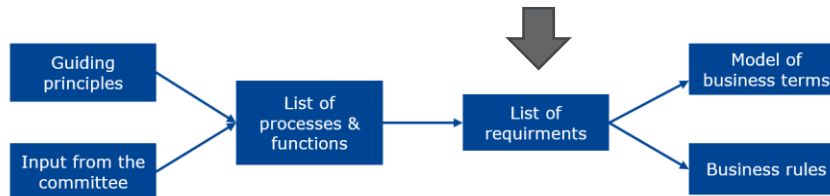

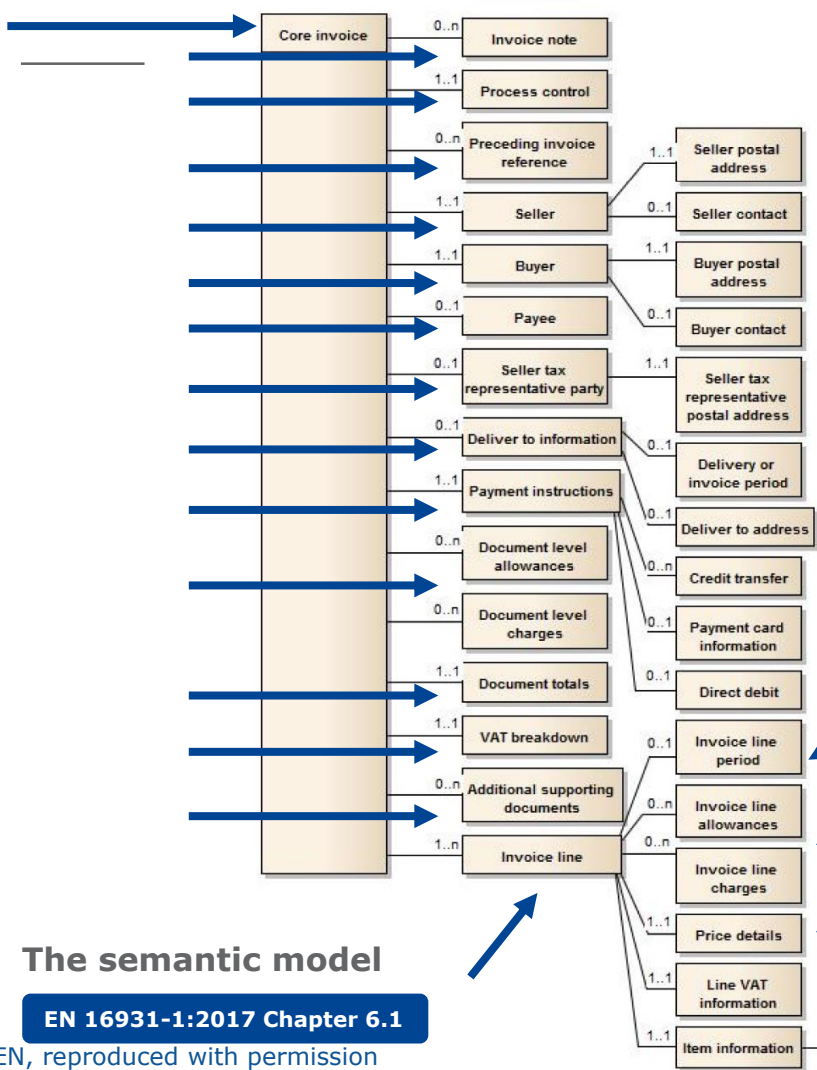

## Examples of key components

Invoice (header)  
 Invoice number (1..1)  
 Issue date (1.1)  
 Type code (1..1)  
 Currency code (1..1)  
 ....

Seller information  
 Name (1..1)  
 Trading name (0..1)  
 Identifier (0..n)  
 Legal registration identifier (0..1)  
 VAT number (0..1)  
 Additional information (0..1)  
 ...

Payment instructions  
 Payment means type code (1..1)  
 Payment means text (0..1)  
 Payment means (0..1)

VAT Breakdown  
 Category taxable amount (1..1)  
 Category tax amount (1..1)  
 Category code (1..1)  
 Category rate (1..1)  
 Exemption text (0..1)  
 Exemption code (0..1)

Item information  
 Name (1..1)  
 Description (0..1)  
 Sellers identifier (0..1)  
 Buyers identifier (0..1)  
 Standard identifier (0..1)  
 Item classification (0..n)  
 Country of origin (0..1)

## The semantic model

EN 16931-1:2017 Chapter 6.1

# Examples of business terms

ID	Level	Cardinality	Business Term	Description	Usage Note	Req. ID	Semantic data type <sup>2</sup>
BT-1	+	1..1	Invoice number	A unique identification of the Invoice.	The sequential number required in Article 226(2) of the directive 2006/112/EC [2], to uniquely identify the Invoice within the business context, time-frame, operating systems and records of the Seller. It may be based on one or more series of numbers, which may include alphanumeric characters. No identification scheme is to be used.	R56	Identifier
BT-2	+	1..1	Invoice issue date	The date when the Invoice was issued.		R56	Date
BT-3	+	1..1	Invoice type code	A code specifying the functional type of the Invoice.	Commercial invoices and credit notes are defined according the entries in UNTDID 1001 [6]. Other entries of UNTDID 1001 [6] with specific invoices or credit notes may be used if applicable.	R44	Code

**ID** – Unique id for each business term

**Level** – indicates depth in model (+, ++, +++, +++++)

**Cardinality** – Indicates optionality, repetitions allowed

**Business term** – name of the business term

**Description** – short description/definition

**Usage note** – guiding/explanatory information

**Req id** – reference to underlying requirement

**Data type** – the type of

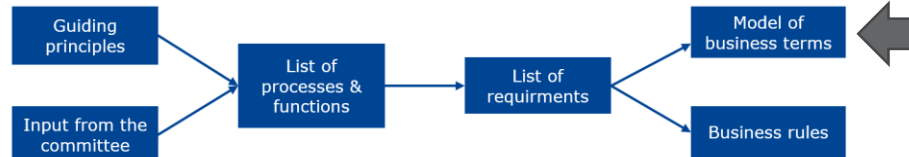

# Semantic datatypes

## Primitive types

- Binary
- Date
- Decimal
- String

Primitive types used in

## Semantic datatypes

- Amount (two decimals)
- Unit Price Amount
- Quantity
- Percentage
- Identifier
- Document reference
- Code
- Date
- Text
- Binary object

Component	Use	Primitive Type	Example
Content	Mandatory	Binary	
Mime Code	Mandatory	String	"image/jpeg"
Filename	Mandatory	String	"drawing5.jpg"

A Receiver of an Invoice, conformant to this document shall accept and process attachments that are of the following mime types (commonly used file extensions are added between brackets):

- application/pdf (.pdf)
- image/png (.png)
- image/jpeg (.jpg)
- text/csv (.csv)
- application/vnd.openxmlformats-officedocument.spreadsheetml.sheet (.xlsx)
- application/vnd.oasis.opendocument.spreadsheet (.ods)

**Data types can have supplementary components/attributes**



---

# Business rules

- In addition to the business terms in the semantic model, rules have been defined
- Expressed as an assertion, a statement which should be true “An Invoice shall have an Invoice number”
- **Integrity constraints** – mandatory elements and rules against negative values
  - The data model is also expressing these through the cardinality
  - The syntaxes may or may not have the same restrictions – if not, the integrity constraint can be implemented through a schematron rule
- **Conditions** – dependencies between business terms
  - Not possible to see by just assessing the business terms
  - The syntaxes do not have these rules built in, but they can be implemented through schematron rules
- All rules are normative – an invoice message shall (MUST) follow the rules to be considered compliant

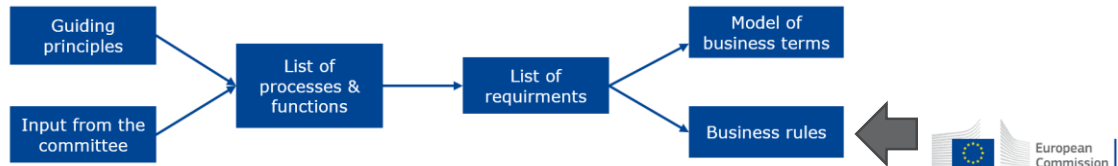

# Business rules – Conditions and integrity constraints

- Conditions – dependencies between terms
- Integrity constraints (In many cases, the data model cardinality indicates the same thing)

ID	Description	Target / context	Business term / group
BR-CO-8	Invoice line charge reason code and Invoice line charge reason shall indicate the same type of charge reason.	Invoice Charges line	BT-144, BT-145
BR-CO-9	The Seller VAT identifier, Seller tax representative VAT identifier, Buyer VAT identifier shall have a prefix in accordance with ISO code ISO 3166-1 alpha-2 by which the country of issue may be identified. Nevertheless, Greece may use the prefix 'EL'.	VAT identifiers	BT-31, BT-48, BT-63
BR-CO-10	Sum of Invoice line net amount = $\sum$ Invoice line net amount.	Document totals	BT-106

**ID** – Unique id for each business rule

**Description** – textual description of the rule

**Target/Context** – the cgroup/class for where the rule applies

**Business term/group** – reference to the term for which the rule applies

# Business rules – VAT Rules

- VAT Rules – Rules for each VAT category

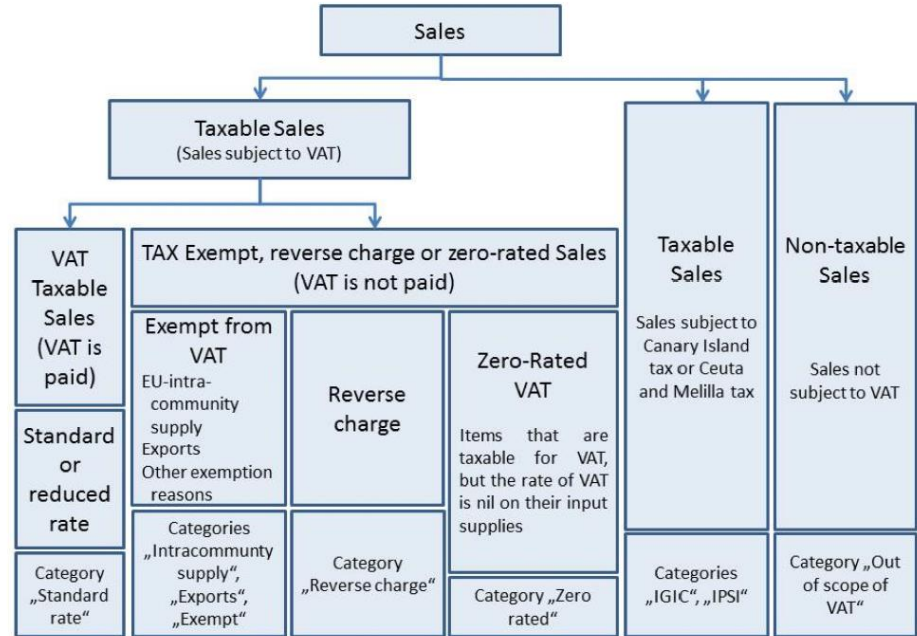

ID	Description
BR-Z-1	An Invoice that contains a line, a document level allowance where the Invoiced item VAT category code (BT-151, BT-152) shall contain in the VAT breakdown (BG-23) exactly one equal with “Zero rated”.
BR-Z-2	An Invoice that contains a line where the Invoiced item VAT category code (BT-151) is “Zero rated” shall contain the Sellers VAT Identifier (BT-31), the Seller Tax registration identifier (BT-32) or the Seller tax representative VAT identifier (BT-63).
BR-Z-3	An Invoice that contains a document level allowance where the Invoiced item VAT category code (BT-95) is “Zero rated” shall contain the Sellers VAT Identifier (BT-31), the Seller Tax registration identifier (BT-32) or the Seller tax representative VAT identifier (BT-63).



---

# Syntaxes which comply with the European standard on e-invoicing

---

**Martin Forsberg**  
DIGIT

---

## Many syntaxes – a problem?

- There are a large number of syntaxes in use
- Many communities are already using e-invoicing since a long time
- Use of many syntaxes result in interoperability problems

(9)

In order to further simplify the use of electronic invoicing and to reduce costs, one of the long-term objectives should be to limit the number of syntaxes used, preferably by concentrating on those most commonly used.

Article 3

Establishment of a European standard

...

The Commission shall request that the relevant European standardisation organisation provide a list with a limited number of syntaxes which comply with the European standard on electronic invoicing, the appropriate syntax bindings and guidelines on transmission interoperability, in order to facilitate the use of such standard.

Article 7

Receipt and processing of electronic invoices

Member States shall ensure that contracting authorities and contracting entities receive and process electronic invoices which comply with the European standard on electronic invoicing whose reference has been published pursuant to Article 3(2) and with any of the syntaxes on the list published pursuant to Article 3(2).

# The standardization request from EC defined a number of criteria

## Req ID Requirement of sub-requirement

1	Comply with the core invoice semantic data model specified in the EN
2	Be international, open and free to use
3	Have a governance and sustainability model
3.1	There is an established organisation maintaining the syntax (format)
3.2	There is a maintenance process that is: <ul style="list-style-type: none"><li>- documented with defined participation and voting rules;</li><li>- governed;</li><li>- open to participation for stakeholders.</li></ul>
3.3	There is a funding model allowing further development and maintenance.
3.4	Support can be provided (consulting, educating, training) to solution providers (implementers) or users (companies, PAs etc.).
4	Be part of a coherent set of standards and technical specifications to support the broader e-procurement process or the broader e-invoicing supply chain
5	Be widely used in the EU or worldwide
6	Be used in production environments (and not just test) by both the public and the private sector
7	Reflect well-accepted technology and aim to incorporate the latest technological developments considered to be state of the art
8	Have guidelines, code lists, validating tools freely available to ease implementation by ICT vendors and suppliers
9	Have a set of official, freely available syntax-dependent artefacts for validation (the XML Schema or Schematron) to support tool independent validation
10	Have an official updating and versioning strategy that takes due account of backward compatibility, as well as appropriate guidelines for customisation that explain how to extend and restrict the syntax

# Specifications from CEN/TC434

Reference	WG	Title
EN 16931-1	WG1	Electronic invoicing - Part 1: Semantic data model of the core elements of an electronic invoice
TS 16931-2	WG2	Electronic invoicing - Part 2: List of syntaxes that comply with EN 16931-1
TS 16931-3-1	WG3	Electronic invoicing - Part 3-1: Methodology for syntax bindings of the core elements of an electronic invoice
TS 16931-3-2	WG3	Electronic invoicing - Part 3-2: Syntax binding for ISO/IEC 19845 (UBL 2.1) invoice and credit note
TS 16931-3-3	WG3	Electronic invoicing - Part 3-3: Syntax binding for UN/CEFACT XML Cross Industry Invoice D16B
TS 16931-3-4	WG3	Electronic invoicing - Part 3-4: Syntax binding for UN/EDIFACT INVOIC D16B
TS 16931-3-5	WG3	Electronic invoicing - Part 3-5: Syntax binding for the Financial Invoice based on ISO 20022
TR 16931-4	WG4	Electronic invoicing - Part 4: Guidelines on interoperability of electronic invoices at the transmission guideline
TR 16931-5	WG5	Electronic invoicing - Part 5: Guidelines on the use of sector or country extensions in conjunction with EN 16931-1, methodology to be applied in the real environment
TR 16931-6	WG6	Electronic invoicing - Part 6: result of the test of EN 16931-1 with respect to its practical application for an end user

# Specifications from CEN/TC434

Reference	WG	Title
EN 16931-1	WG1	Electronic invoicing - Part 1: Semantic data model of the core elements of an electronic invoice
TS 16931-2	WG2	Electronic invoicing - Part 2: List of syntaxes that comply with EN 16931-1
TS 16931-3-1	WG3	Electronic invoicing - Part 3-1: Methodology for syntax bindings of the core elements of an electronic invoice
TS 16931-3-2	WG3	Electronic invoicing - Part 3-2: Syntax binding for ISO/IEC 19845 (UBL 2.1) invoice and credit note
TS 16931-3-3	WG3	Electronic invoicing - Part 3-3: Syntax binding for UN/CEFACT XML Cross Industry Invoice D16B
TS 16931-3-4	WG3	Electronic invoicing - Part 3-4: Syntax binding for UN/EDIFACT INVOIC D16B
TS 16931-3-5	WG3	Electronic invoicing - Part 3-5: Syntax binding for the Financial Invoice based on ISO 20022
TR 16931-4	WG4	Electronic invoicing - Part 4: Guidelines on interoperability of electronic invoices at the transmission guideline
TR 16931-5	WG5	Electronic invoicing - Part 5: Guidelines on the use of sector or country extensions in conjunction with EN 16931-1, methodology to be applied in the real environment
TR 16931-6	WG6	Electronic invoicing - Part 6: result of the test of EN 16931-1 with respect to its practical application for an end user



# Specifications from CEN/TC434

Reference	WG	Title
EN 16931-1	WG1	Electronic invoicing - Part 1: Semantic data model of the core elements of an electronic invoice
TS 16931-2	WG2	Electronic invoicing - Part 2: List of syntaxes that comply with EN 16931-1
TS 16931-3-1	WG3	Electronic invoicing - Part 3-1: Methodology for syntax bindings of the core elements of an electronic invoice
TS 16931-3-2	WG3	Electronic invoicing - Part 3-2: Syntax binding for ISO/IEC 19845 (UBL 2.1) invoice and credit note
TS 16931-3-3	WG3	Electronic invoicing - Part 3-3: Syntax binding for UN/CEFACT XML Cross Industry Invoice D16B
TS 16931-3-4	WG3	Electronic invoicing - Part 3-4: Syntax binding for UN/EDIFACT INVOIC D16B
TS 16931-3-5	WG3	Electronic invoicing - Part 3-5: Syntax binding for the Financial Invoice based on ISO 20022
TR 16931-4	WG4	Electronic invoicing - Part 4: Guidelines on interoperability of electronic invoices at the transmission guideline
TR 16931-5	WG5	Electronic invoicing - Part 5: Guidelines on the use of sector or country extensions in conjunction with EN 16931-1, methodology to be applied in the real environment
TR 16931-6	WG6	Electronic invoicing - Part 6: result of the test of EN 16931-1 with respect to its practical application for an end user



**Requirements and Methodology specifications from TC 434**

**Content Specifications from TC 434**

**Content Specifications from other groups**

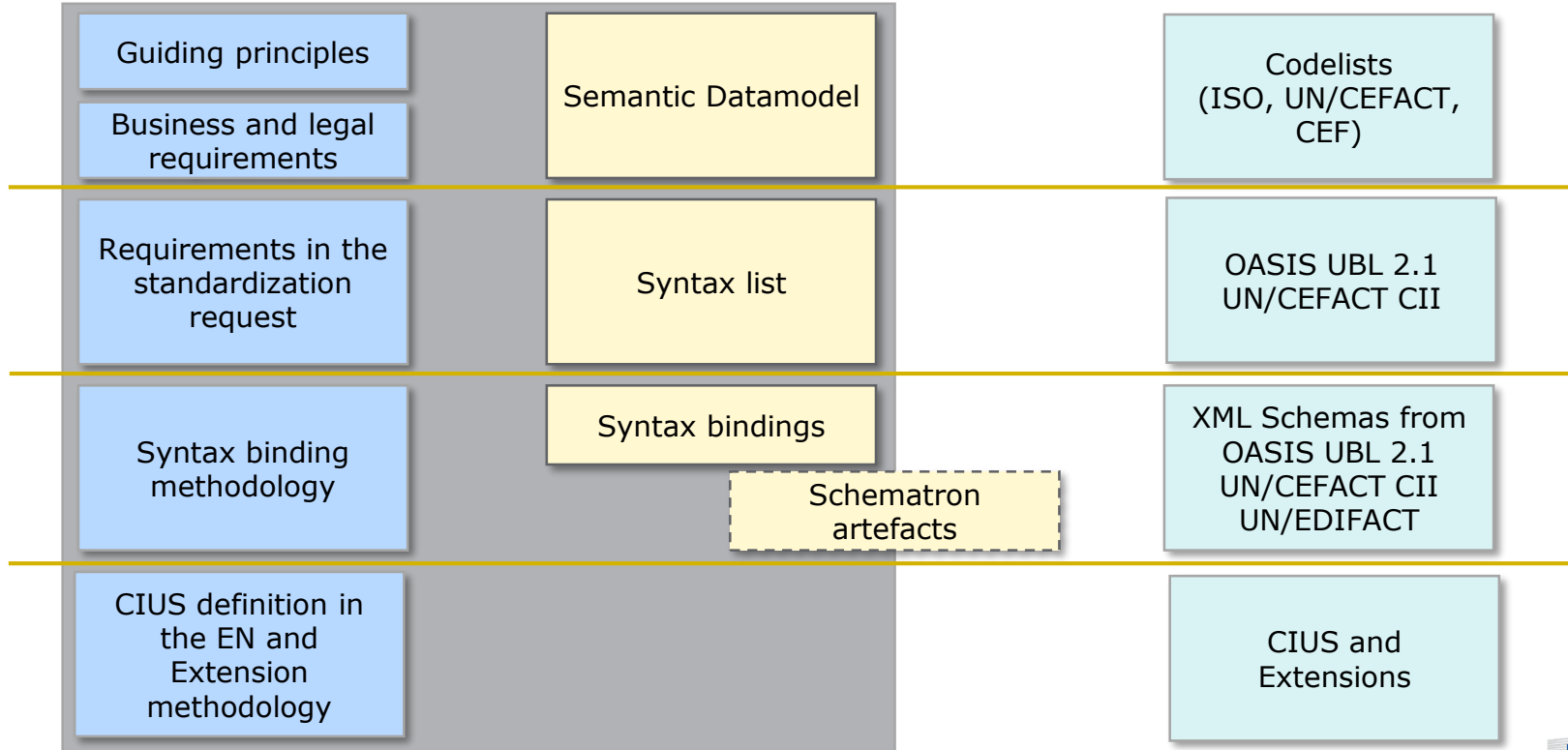



---

# Usage specifications and compliance

---

**Martin Forsberg**  
DIGIT

---

# Compliance and conformance - The European standard defines these concepts

## **Compliant**

some or all features of the core invoice model are used and all rules of the core invoice model are respected



Core Invoice Usage Specifications

## **Conformant**

all rules of the core invoice model are respected and some additional features not defined in the core invoice model are also used



Extensions

**From article 7 in the directive**

### ***Receipt and processing of electronic invoices***

*Member States shall ensure that contracting authorities and contracting entities receive and process electronic invoices which **comply** with the European standard on electronic invoicing whose reference has been published pursuant to Article 3(2) and with any of the syntaxes on the list published pursuant to Article 3(2).*

---

## Core – something in common

### **IMPORTANT**

An invoice which follows a CIUS  
MUST ALWAYS also be compliant  
towards the (non-restricted)  
norm.

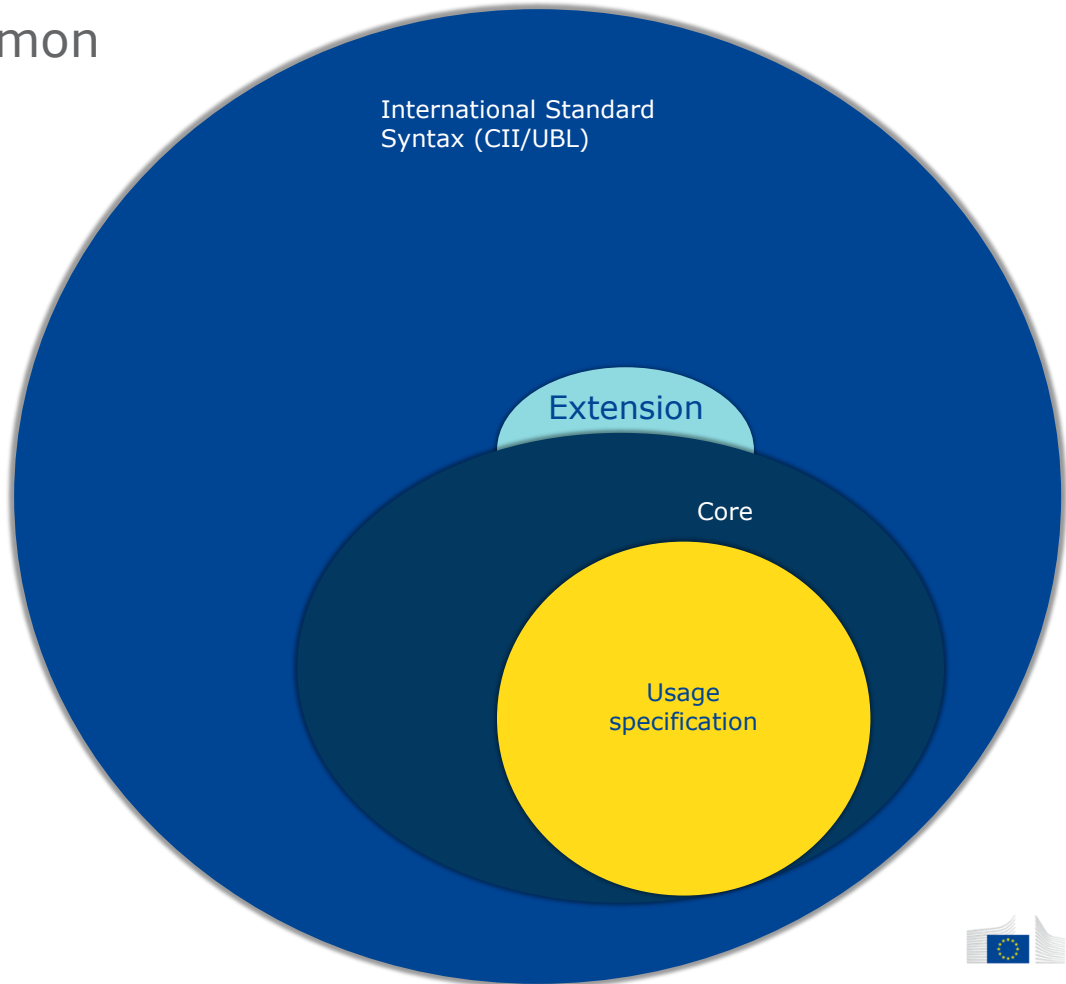

---

# Requirements for the contracting authorities/entities

## From article 7

### ***Receipt and processing of electronic invoices***

*Member States shall ensure that contracting authorities and contracting entities **receive and process electronic invoices which comply with the European standard on electronic invoicing** whose reference has been published pursuant to Article 3(2) and with any of the syntaxes on the list published pursuant to Article 3(2).*

---

# Claiming compliance towards the norm

## ***Compliance of sending or receiving party***

*A receiving party may only claim compliance to the core invoice model if he accepts invoices that comply with the core invoice model in general, **or with a CIUS**, that is itself compliant with the core invoice model.*

---

# What is allowed to restrict in a Core Invoice Usage Specification

- "Forbid" optional elements 0..n/0..1 → 0..0
- Make definition narrower
- Add synonyms or explanatory text
- Make optional element mandatory
- Limit allowed number of repetitions
- Change data type to narrower representation (alphanumeric → numeric)
- Limited allowed code values
- Add additional business rules or make existing more restrictive
- Restrict field lengths
- Require certain formatting on values
- Restrict number of decimals/fractions

## **IMPORTANT**

An invoice which follows a CIUS **MUST ALWAYS** also be compliant towards the (non-restricted) norm.



# A few scenarios

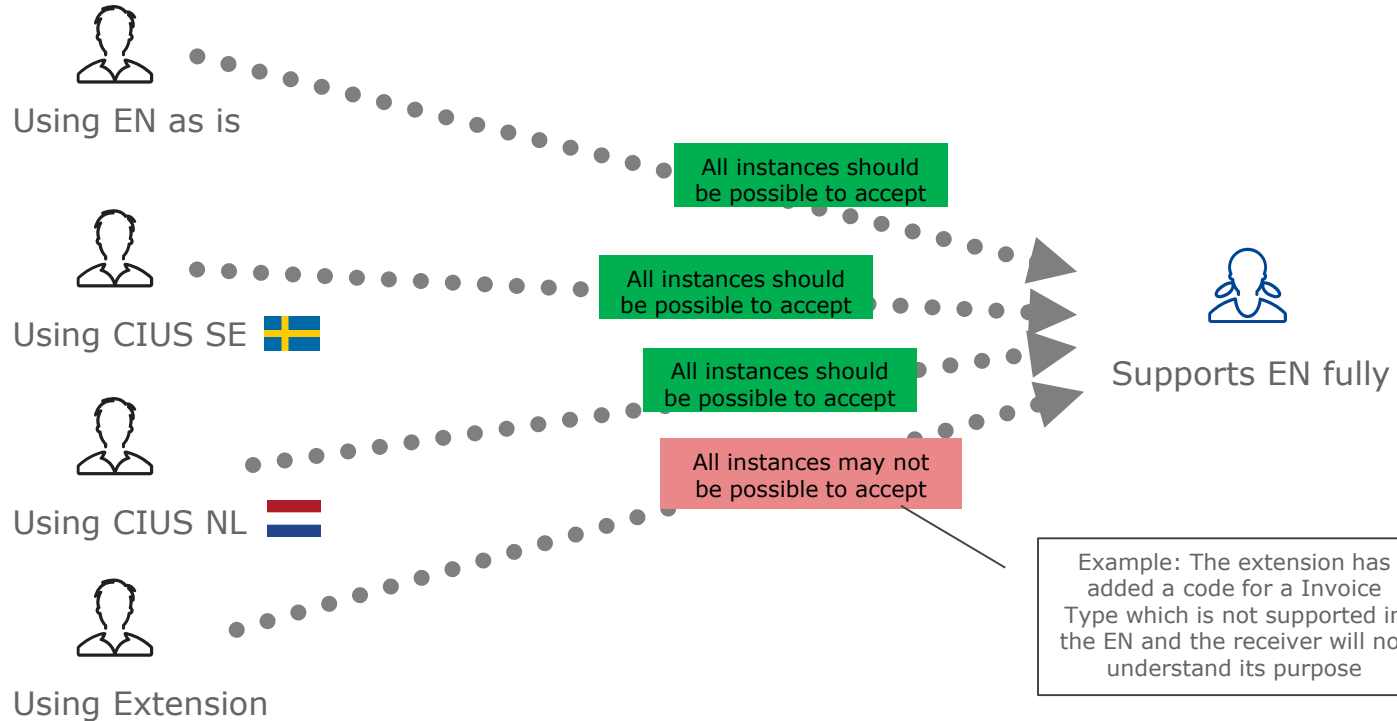

Assuming the invoices are conformant against its specification (EN/CIUS/Extension)

# A few more scenarios

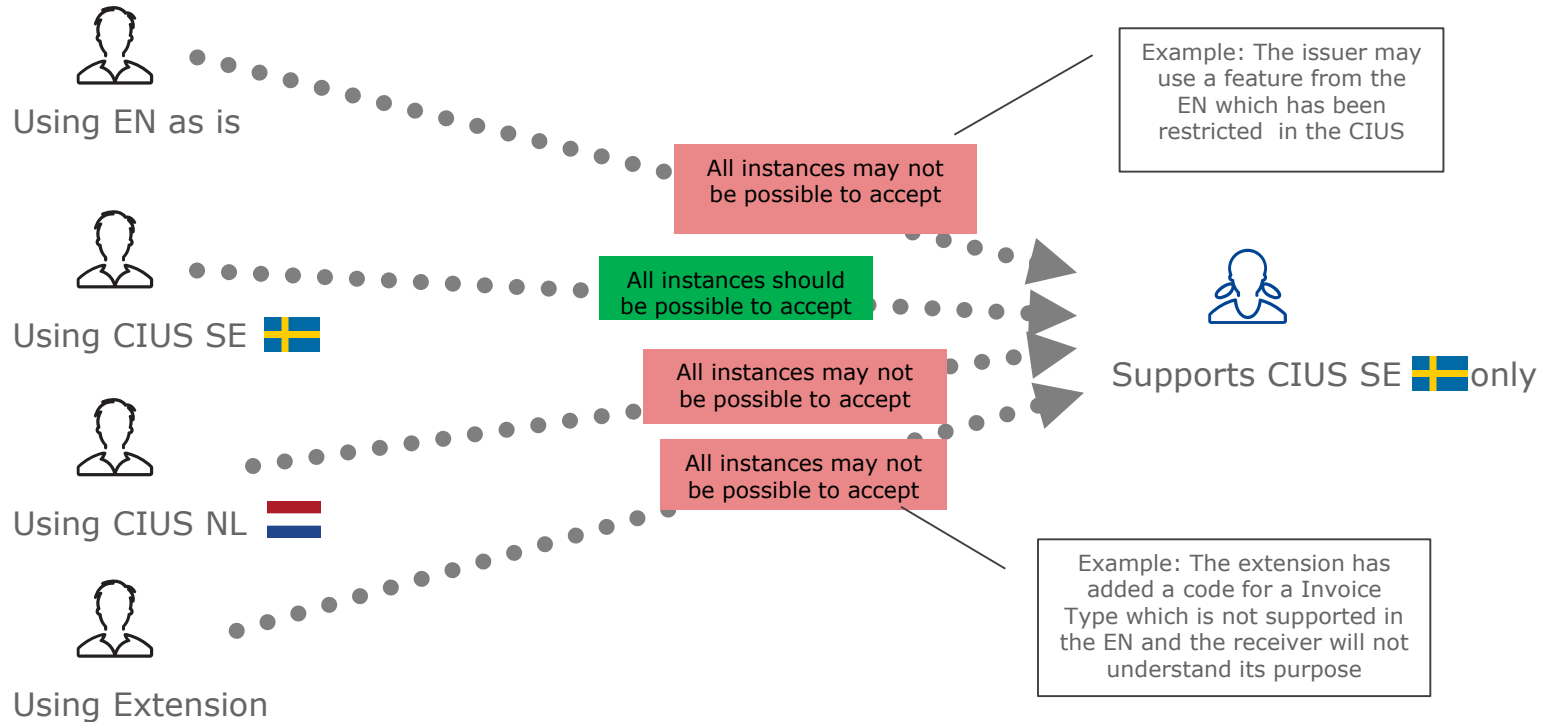

Assuming the invoices are conformant against its specification (EN/CIUS/Extension)

Community-driven Registry of CIUS (Core Invoice Usage Specifications) and Extensions

Created by Ines COSTA, last modified by Lutz RABE on Oct 02, 2017

<b>Topic</b>	Registry of CIUS (Core Invoice Usage Specifications) and Extensions
<b>Excerpt</b>	This page aims to give the invoicing community the opportunity to share the ongoing and planned initiatives across Member States and sectors to create CIUS and Extensions on the European standard on invoicing.
<b>Status</b>	<b>OPEN</b>
<b>Deadline</b>	Ongoing

### Provide information on CIUS and Extensions

The table below aims to give the invoicing community the opportunity to share the ongoing and planned initiatives across Member States and sectors to create CIUS and Extensions on the European standard on invoicing. The content is community-driven and the contributors take the sole responsibility of the information shared. Please note that the information available does not have an authoritative character.

We invite you to contribute to build on the information available about the CIUS and Extensions on the European standard on invoicing by filling the table below:

Name	Type	Country	Sector	Purpose of the CIUS or Extension	Publisher	Governor	Underlying specification	Further info	Status	Contact
OpenPEPPOL BIS 3.0 5A	CIUS	Any	Any	Restricts the business process scope of the EN with reference to BIS2 business processes.	OpenPEPPOL	OpenPEPPOL	EN16931	<a href="https://peppol.eu/downloads/post-award/">https://peppol.eu/downloads/post-award/</a>	<b>DEVELOPMENT</b>	<a href="#">@Olav Astad KRISTIANSEN</a>
Icelandic national CIUS	CIUS	IS	Any	Applies national regulations and imposes data format to payment instructions when using national payment clearing services.	IST	ISgov	PEPPOL BIS 3.0 5A	<a href="http://www.stadlar.is/stadiastarf/flagstadiarad-i-upplysingataekni.aspx">http://www.stadlar.is/stadiastarf/flagstadiarad-i-upplysingataekni.aspx</a>	<b>PLANNED</b>	<a href="#">@Georg BIRGISSON</a>
Austrian national CIUS	CIUS	AT	Any	Apply national regulations	BRZ	BRZ	EN16931		<b>DEVELOPMENT</b>	<a href="#">@Philip HELGER</a>
Austrian government CIUS	CIUS	AT	Any	Additional regulations only applying to the mandatory government interface. This CIUS builds on top of the Austrian national CIUS!	BRZ	BRZ	AT national CIUS		<b>DEVELOPMENT</b>	<a href="#">@Philip HELGER</a>
Italian national CIUS	CIUS	IT	Any	Applies national regulations and restricts data format in compliance with invoice national format (FatturaPA)	AgID, AdE	AgID, AdE	EN16931	<a href="http://www.agid.gov.it/agenda-digitale/publica-amministrazione/cef-telecom-invoicing-eigor">http://www.agid.gov.it/agenda-digitale/publica-amministrazione/cef-telecom-invoicing-eigor</a>	<b>DEVELOPMENT</b>	Fabio MASSIMI
NLCIUS	CIUS	NL	Any	Applies national regulations and conventions. The purpose of the NLCIUS is to prevent the need for any other NL governmental or organizational specific CIUS.	NEN / SMeF	NEN / SMeF	EN16931	NLCIUS is a joint initiative of government, industry and standardization bodies in the	<b>DEVELOPMENT</b> expected: dec 2017	Michiel Stormbrink (TNO) Fred van Blommestein (Flowcanto)

# Access to the specifications

Negotiations with the EC on sponsored access

Be aware of the copyright rules

cen European Committee for Standardization

CEN COMMUNITY TECHNICAL BODIES STANDARDS EVOLUTION AND FORECAST SEARCH STANDARDS

Technical Bodies > CEN/TC 434

## CEN/TC 434 - Electronic Invoicing

General Structure Work programme Published Standards

EN FR DE

### CEN/TC 434 Published Standards

Reference, Title	Publication date	Sales Points
<a href="#">CEN/TR 16931-4:2017</a> (WI=00434004) Electronic invoicing - Part 4: Guidelines on interoperability of electronic invoices at the transmission level	2017-07-05	
<a href="#">CEN/TR 16931-5:2017</a> (WI=00434005) Electronic invoicing - Part 5: Guidelines on the use of sector or country extensions in conjunction with EN 16931-1, methodology to be applied in the real environment	2017-07-05	
<a href="#">CEN/TR 16931-6:2017</a> (WI=00434006) Electronic invoicing - Part 6: Result of the test of EN 16931-1 with respect to its practical application for an end user	2017-10-18	
<a href="#">CEN/TS 16931-2:2017</a> (WI=00434002) Electronic invoicing - Part 2: List of syntaxes that comply with EN 16931-1	2017-06-28	
<a href="#">CEN/TS 16931-3-1:2017</a> (WI=00434007) Electronic invoicing - Part 3-1: Methodology for syntax bindings of the core elements of an electronic invoice	2017-07-05	
<a href="#">CEN/TS 16931-3-2:2017</a> (WI=00434008) Electronic invoicing - Part 3-2: Syntax binding for ISO/IEC 19845 (UBL 2.1) invoice and credit note	2017-10-18	
<a href="#">CEN/TS 16931-3-2:2017/AC:2018</a> (WI=00434C01) Electronic invoicing - Part 3-2: Syntax binding for ISO/IEC 19845 (UBL 2.1) invoice and credit note	2018-07-18	
<a href="#">CEN/TS 16931-3-3:2017</a> (WI=00434009) Electronic invoicing - Part 3-3: Syntax binding for UN/CEFACT XML Industry Invoice D16B	2017-10-18	
<a href="#">CEN/TS 16931-3-4:2017</a> (WI=00434010) Electronic invoicing - Part 3-4: Syntax binding for UN/EDIFACT INVOIC D16B	2017-10-18	
<a href="#">EN 16931-1:2017</a> (WI=00434001) Electronic invoicing - Part 1: Semantic data model of the core elements of an electronic invoice	2017-06-28	



# PEPPOL BIS BILLING v3



---

## Guiding principles in the development

- New functions and processes introduced by the EN should be adopted ***unless there are explicit reasons not to add these.***
- Enable existing PEPPOL users to continue their current invoicing, in the extent possible, in a EN compliant way.
- It should be possible to use the mandatory invoice BIS without direct bilateral agreements.

### **From chapter 5.2.13 in EN**

*Self-billing may be introduced only if there is a prior agreement between the two parties and provided that ...*

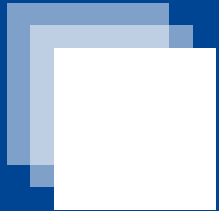

Help/guidance to implementers

# Home

## Documentation

**Business Interoperability Specifications (BIS)**

Migration plan

## Syntax

**UBL Invoice**

**UBL Credit Note**

Please note that all element names are inherited from EN16931 and naming use the term invoice, but this covers both invoice and credit notes. The tag names are correct according to the UBL Credit note schema

## Rules

**EN16931 model bound to UBL**

**Rules for PEPPOL BIS 3.0 Billing**



# Calculation

## 9.1.1. UBL syntax calculation formulas

The following elements show the legal monetary totals for an invoice or credit note

Element	Formula
<cbc:LineExtensionAmount>	$\sum (\text{cac:InvoiceLine}/\text{cbc:LineExtensionAmount})$
<cbc:AllowanceTotalAmount>	$\sum (\text{cac:AllowanceCharge}[\text{ChargeIndicator}='false']/\text{cbc:Amount})$
<cbc:ChargeTotalAmount>	$\sum (\text{cac:AllowanceCharge}[\text{ChargeIndicator}='true']/\text{cbc:Amount})$
<cbc:TaxExclusiveAmount>	$\text{cac:LegalMonetaryTotal}/\text{cbc:LineExtensionAmount}$ $- \text{cac:LegalMonetaryTotal}/\text{cbc:AllowanceTotalAmount}$ $+ \text{cac:LegalMonetaryTotal}/\text{cbc:ChargeTotalAmount}$
<cbc:TaxInclusiveAmount>	$\text{cac:LegalMonetaryTotal}/\text{cbc:TaxExclusiveAmount}$ $+ \text{cac:TaxTotal}/\text{cbc:TaxAmount}$
<cbc:PrepaidAmount>	Not applicable
<cbc:PayableRoundingAmount>	Not applicable
<cbc:PayableAmount>	$\text{cac:LegalMonetaryTotal}/\text{cbc:TaxInclusiveAmount}$ $- \text{cac:LegalMonetaryTotal}/\text{cbc:PrepaidAmount}$ $+ \text{cac:LegalMonetaryTotal}/\text{cbc:PayableRoundingAmount}$

## 9.3. Calculation of allowance/charge amount

Allowance and charge on document- and line level consists of elements carrying information on the allowance/charge base amount and the allowance/charge percentage. These are, if present in the invoice instance, used for calculating the allowance/charge amount.

If base amount is present, the percentage shall also be present, and if percentage is present, the base amount shall also be present, and the calculation of the amount shall be:

$$\text{Amount} = \text{Base amount} \times (\text{Percentage} \div 100)$$

Formula

*UBL example of calculations of allowances and charges where base amount and percentage exist*

```
<cac:AllowanceCharge>
  <cbc:ChargeIndicator>true</cbc:ChargeIndicator>
  <cbc:AllowanceChargeReasonCode>CG</cbc:AllowanceChargeReasonCode>
  <cbc:AllowanceChargeReason>Cleaning</cbc:AllowanceChargeReason>
  <cbc:MultiplierFactorNumeric>20</cbc:MultiplierFactorNumeric> ②
  <cbc:Amount currencyID="EUR">200</cbc:Amount> ③
  <cbc:BaseAmount currencyID="EUR">1000</cbc:BaseAmount> ①
  <cac:TaxCategory>
    <cbc:ID>S</cbc:ID>
    <cbc:Percent>25</cbc:Percent>
    <cac:TaxScheme>
      <cbc:ID>VAT</cbc:ID>
    </cac:TaxScheme>
  </cac:TaxCategory>
</cac:AllowanceCharge>
```

Example with call outs

- ① Base amount, to be used with the percentage to calculate the amount
- ② Charge percentage
- ③  $\text{Base amount} \times (\text{Percentage} \div 100) = \text{Amount}$

# Negative invoices

## UBL example of invoice to be corrected

```
<cbc:InvoiceTypeCode>380</cbc:InvoiceTypeCode>
<!-- Code omitted for clarity -->
<cac:AllowanceCharge>
  <cbc:ChargeIndicator>true</cbc:ChargeIndicator>
  <cbc:AllowanceChargeReason>Insurance</cbc:AllowanceChargeReason>
  <cbc:Amount currencyID="EUR">25</cbc:Amount>❶
  <cac:TaxCategory>
    <cbc:ID>S</cbc:ID>
    <cbc:Percent>25.0</cbc:Percent>
    <cac:TaxScheme>
      <cbc:ID>VAT</cbc:ID>
    </cac:TaxScheme>
  </cac:TaxCategory>
</cac:AllowanceCharge>
<!-- Code omitted for clarity -->
<cac:LegalMonetaryTotal>
  <cbc:LineExtensionAmount currencyID="EUR">1300</cbc:LineExtensionAmount>
  <cbc:TaxExclusiveAmount currencyID="EUR">1325</cbc:TaxExclusiveAmount>
  <cbc:TaxInclusiveAmount currencyID="EUR">1656.25</cbc:TaxInclusiveAmount>
  <cbc:ChargeTotalAmount currencyID="EUR">25</cbc:ChargeTotalAmount>
  <cbc:PayableAmount currencyID="EUR">1656.25</cbc:PayableAmount>
</cac:LegalMonetaryTotal>

<cac:InvoiceLine>
  <cbc:ID>1</cbc:ID>❷
  <cbc:InvoicedQuantity unitCode="DAY" unitCodeListID="UNECERec20">7</cbc:InvoicedQuantity>
  <cbc:LineExtensionAmount currencyID="EUR">2800</cbc:LineExtensionAmount>
  <!-- Code omitted for clarity -->
  <cac:Price>
    <cbc:PriceAmount currencyID="EUR">400</cbc:PriceAmount>
  </cac:Price>

<cac:InvoiceLine>
  <cbc:ID>2</cbc:ID>❸
  <cbc:InvoicedQuantity unitCode="DAY" unitCodeListID="UNECERec20">-3</cbc:InvoicedQuantity>
  <cbc:LineExtensionAmount currencyID="EUR">-1500</cbc:LineExtensionAmount>
  <!-- Code omitted for clarity -->
  <cac:Price>
    <cbc:PriceAmount currencyID="EUR">500</cbc:PriceAmount>
  </cac:Price>
```

- ❶ Charge amount
- ❷ Invoice line 1 with positive quantity and line amount
- ❸ Invoice line 2 with negative quantity and line amount

## 4.6.1. When crediting by means of credit note

The function of crediting or debiting is controlled merely by the business document type (e.g. 380 or 381) while the representation of the amount, including its sign, is not affected.

### UBL example of credit note correcting the example invoice above

```
<cbc:CreditNoteTypeCode>381</cbc:CreditNoteTypeCode>❶
<!-- Code omitted for clarity -->
<cac:AllowanceCharge>
  <cbc:ChargeIndicator>true</cbc:ChargeIndicator>
  <cbc:AllowanceChargeReason>Insurance</cbc:AllowanceChargeReason>
  <cbc:Amount currencyID="EUR">25</cbc:Amount>❷
  <cac:TaxCategory>
    <cbc:ID>S</cbc:ID>
    <cbc:Percent>25.0</cbc:Percent>
    <cac:TaxScheme>
      <cbc:ID>VAT</cbc:ID>
    </cac:TaxScheme>
  </cac:TaxCategory>
</cac:AllowanceCharge>
<!-- Code omitted for clarity -->
<cac:LegalMonetaryTotal>
  <cbc:LineExtensionAmount currencyID="EUR">1300</cbc:LineExtensionAmount>
  <cbc:TaxExclusiveAmount currencyID="EUR">1325</cbc:TaxExclusiveAmount>
  <cbc:TaxInclusiveAmount currencyID="EUR">1656.25</cbc:TaxInclusiveAmount>
  <cbc:ChargeTotalAmount currencyID="EUR">25</cbc:ChargeTotalAmount>
  <cbc:PayableAmount currencyID="EUR">1656.25</cbc:PayableAmount>
</cac:LegalMonetaryTotal>

<cac:CreditNoteLine>
  <cbc:ID>1</cbc:ID>❸
  <cbc:CreditedQuantity unitCode="DAY" unitCodeListID="UNECERec20">7</cbc:CreditedQuantity>
  <cbc:LineExtensionAmount currencyID="EUR">2800</cbc:LineExtensionAmount>
  <!-- Code omitted for clarity -->
  <cac:Price>
    <cbc:PriceAmount currencyID="EUR">400</cbc:PriceAmount>
  </cac:Price>

<cac:CreditNoteLine>
  <cbc:ID>2</cbc:ID>❹
  <cbc:CreditedQuantity unitCode="DAY" unitCodeListID="UNECERec20">-3</cbc:CreditedQuantity>
  <cbc:LineExtensionAmount currencyID="EUR">-1500</cbc:LineExtensionAmount>
  <!-- Code omitted for clarity -->
  <cac:Price>
    <cbc:PriceAmount currencyID="EUR">500</cbc:PriceAmount>
  </cac:Price>
```

- ❶ Code 381 indicating a credit note
- ❷ Charge amount
- ❸ Invoice line 1 with positive quantity and line amount
- ❹ Invoice line 2 with negative quantity and line amount

## 4.6.2. When crediting by means of negative invoice

The function of crediting or debiting is controlled merely by the sign (i.e. plus sign or minus sign) of the amount concerned, while the business document type (e.g. 380) has no relevance on the operation ("to credit") itself.

### UBL example of negative invoice correcting the example invoice above

```
<cbc:InvoiceTypeCode>380</cbc:InvoiceTypeCode>❶
<!-- Code omitted for clarity -->
<cac:AllowanceCharge>
  <cbc:ChargeIndicator>true</cbc:ChargeIndicator>
  <cbc:AllowanceChargeReason>Insurance</cbc:AllowanceChargeReason>
  <cbc:Amount currencyID="EUR">-25</cbc:Amount>❷
  <cac:TaxCategory>
    <cbc:ID>S</cbc:ID>
    <cbc:Percent>25.0</cbc:Percent>
    <cac:TaxScheme>
      <cbc:ID>VAT</cbc:ID>
    </cac:TaxScheme>
  </cac:TaxCategory>
</cac:AllowanceCharge>
<!-- Code omitted for clarity -->
<cac:LegalMonetaryTotal>❸
  <cbc:LineExtensionAmount currencyID="EUR">-1300</cbc:LineExtensionAmount>
  <cbc:TaxExclusiveAmount currencyID="EUR">-1325</cbc:TaxExclusiveAmount>
  <cbc:TaxInclusiveAmount currencyID="EUR">-1656.25</cbc:TaxInclusiveAmount>
  <cbc:ChargeTotalAmount currencyID="EUR">-25</cbc:ChargeTotalAmount>
  <cbc:PayableAmount currencyID="EUR">-1656.25</cbc:PayableAmount>
</cac:LegalMonetaryTotal>

<cac:InvoiceLine>
  <cbc:ID>1</cbc:ID>❹
  <cbc:InvoicedQuantity unitCode="DAY" unitCodeListID="UNECERec20">-7</cbc:InvoicedQuantity>
  <cbc:LineExtensionAmount currencyID="EUR">-2800</cbc:LineExtensionAmount>
  <!-- Code omitted for clarity -->
  <cac:Price>
    <cbc:PriceAmount currencyID="EUR">400</cbc:PriceAmount>❺
  </cac:Price>

<cac:InvoiceLine>
  <cbc:ID>2</cbc:ID>❻
  <cbc:InvoicedQuantity unitCode="DAY" unitCodeListID="UNECERec20">3</cbc:InvoicedQuantity>
  <cbc:LineExtensionAmount currencyID="EUR">1500</cbc:LineExtensionAmount>
  <!-- Code omitted for clarity -->
  <cac:Price>
    <cbc:PriceAmount currencyID="EUR">500</cbc:PriceAmount>
  </cac:Price>
```

- ❶ Code 380 indicating an invoice
- ❷ Charge amount is negative to correct the original invoice
- ❸ All document level amounts are negative
- ❹ Invoice line 1 with originally positive quantity and line amount, now both negative
- ❺ Price amount must always be positive, and is not changed
- ❻ Invoice line 2 with originally negative quantity and line amount, now positive

# Home

## Documentation

[Business Interoperability Specifications \(BIS\)](#)

[Migration plan](#)

## Syntax

[UBL Invoice](#)

[UBL Credit Note](#)

Please note that all element names are inherited from EN16931 and naming use the term invoice, but this covers both invoice and credit notes. The tag names are correct according to the UBL Credit note schema

## Rules

[EN16931 model bound to UBL](#)

[Rules for PEPPOL BIS 3.0 Billing](#)

# Syntax binding, overview

## UBL Invoice

Card	Name	Description
1..1	ubl:Invoice	
1..1	• cbc:CustomizationID	<b>Specification identifier</b> <i>An identification of the specification containing the total set of rules regarding semantic content, cardinalities and business rules to which the data contained in the instance document conforms.</i> Default value: <code>urn:cen.eu:en16931:2017#compliant#urn:fdc:peppol.eu:2017:poacc:billing:3.0</code>
1..1	• cbc:ProfileID	<b>Business process type</b> <i>Identifies the business process context in which the transaction appears, to enable the Buyer to process the Invoice in an appropriate way.</i> Default value: <code>urn:fdc:peppol.eu:2017:poacc:billing:01:1.0</code>
1..1	• cbc:ID	<b>Invoice number</b> <i>A unique identification of the Invoice. The sequential number required in Article 226(2) of the directive 2006/112/EC [2], to uniquely identify the Invoice within the business context, time-frame, operating systems and records of the Seller. No identification scheme is to be used.</i> Example value: <code>33445566</code>
1..1	• cbc:IssueDate	<b>Invoice issue date</b> <i>The date when the Invoice was issued. Format "YYYY-MM-DD"</i> Example value: <code>2017-11-01</code>
0..1	• cbc:DueDate	<b>Payment due date</b> <i>The date when the payment is due.Format "YYYY-MM-DD"</i> Example value: <code>2017-11-01</code>
1..1	• cbc:InvoiceTypeCode	<b>Invoice type code</b> <i>A code specifying the functional type of the Invoice.</i> Example value: <code>380</code>
0..1	• cbc:Note	<b>Invoice note</b> <i>A textual note that gives unstructured information that is relevant to the Invoice as a whole.Such as the reason for any correction or assignment note in case the invoice has been factored.</i> Example value: <code>Please note our new phone number 33 44 55 66</code>
0..1	• cbc:TaxPointDate	<b>Value added tax point date</b> <i>The date when the VAT becomes accountable for the Seller and for the Buyer in so far as that date can be determined and differs from the date of issue of the invoice, according to the VAT directive.This element is required if the Value added tax point date is different from the Invoice issue date.</i> Example value: <code>2017-11-01</code>

# Syntax binding, details

Home / UBL Invoice / ubl:Invoice / cac:AccountingSupplierParty / cac:Party / cac:PartyLegalEntity / cbc:CompanyID

## cbc:CompanyID

An identifier issued by an official registrar that identifies the Seller as a legal entity or person.

**Namespace** `cbc` urn:oasis:names:specification:ubl:schema:xsd:CommonBasicComponents-2

**Data type** Identifier

**Example value** 987654321

**Business terms** BT-30

**Attributes**

Use	Name	Description
O	@schemelD	<b>Seller legal registration identifier identification scheme identifier</b> <i>The identification scheme identifier of the Seller legal registration identifier.</i> Example value: 0002

**Rules**

Identifier/Error message	Flag
<b>BR-CO-26</b> [BR-CO-26]-In order for the buyer to automatically identify a supplier, the Seller identifier (BT-29), the Seller legal registration identifier (BT-30) and/or the Seller VAT identifier (BT-31) shall be present.	fatal

# Syntax binding, rules

## BR-CO-26

1

**Message** [BR-CO-26]-In order for the buyer to automatically identify a supplier, the Seller identifier (BT-29), the Seller legal registration identifier (BT-30) and/or the Seller VAT identifier (BT-31) shall be present.

**Context** `cac:AccountingSupplierParty`

2

**Test** `exists(cac:Party/cac:PartyTaxScheme/cbc:CompanyID) or exists(cac:Party/cac:PartyIdentification/cbc:ID) or exists(cac:Party/cac:PartyLegalEntity/cbc:CompanyID)`

**Usage**

- `/ ubl:Invoice / cac:AccountingSupplierParty / cac:Party / cac:PartyIdentification / cbc:ID`
- `/ ubl:Invoice / cac:AccountingSupplierParty / cac:Party / cac:PartyTaxScheme / cbc:CompanyID`
- `/ ubl:Invoice / cac:AccountingSupplierParty / cac:Party / cac:PartyLegalEntity / cbc:CompanyID`
- `/ ubl:CreditNote / cac:AccountingSupplierParty / cac:Party / cac:PartyIdentification / cbc:ID`
- `/ ubl:CreditNote / cac:AccountingSupplierParty / cac:Party / cac:PartyTaxScheme / cbc:CompanyID`
- `/ ubl:CreditNote / cac:AccountingSupplierParty / cac:Party / cac:PartyLegalEntity / cbc:CompanyID`

3



## Restrictions on EN16931

# Added rules to ensure correct use according to EN16931

## From BT-93 in the datamodel in EN16931

*The base amount that may be used, in conjunction with the document level allowance percentage, to calculate the document level allowance amount*

BT-93, BT-100, BT-137, BT-142	<b>Allowance/charge base amount</b>	Add new non-conflicting business rule to existing element(s)	Allowance/charge base amount shall be provided when allowance/charge percentage is provided.	PEPPOL-EN16931-R041
BT-94, BT-101, BT-138, BT-143	<b>Allowance/charge percentage</b>	Add new non-conflicting business rule to existing element(s)	Allowance/charge percentage shall be provided when allowance/charge base amount is provided.	PEPPOL-EN16931-R042
BT-94, BT-101, BT-138, BT-143	<b>Allowance/charge amount</b>	Add new non-conflicting business rule to existing element(s)	If base amount and percentage exists in the instance, then Allowance/charge amount= base amount $\times$ (percentage $\div$ 100)	PEPPOL-EN16931-R040



# Restricting code lists

Specific code lists for the invoice

Invoice Type Code

<b>Document location</b>	cbc:InvoiceTypeCode
<b>Source codelist</b>	<a href="#">Subset of UN/CEFACT code list 1001_D.16B</a>

Table 8. Code list

Code	Name	Description	Synonym with	UBL Message type
380	<b>Commercial invoice</b>	Document/message claiming payment for goods or services supplied under conditions agreed between seller and buyer.		Invoice
393	<b>Factored invoice</b>	Invoice assigned to a third party for collection.	380	Invoice
82	<b>Metered services invoice</b>	Document/message claiming payment for the supply of metered services (e.g., gas, electricity, etc.) supplied to a fixed meter whose consumption is measured over a period of time.	380	Invoice
80	<b>Debit note related to goods or services</b>	Debit information related to a transaction for goods or services to the relevant party.	380	Invoice
84	<b>Debit note related to financial adjustments</b>	Document/message for providing debit information related to financial adjustments to the relevant party.	380	Invoice
395	<b>Consignment invoice</b>	Commercial invoice that covers a transaction other than one involving a sale.	380	Invoice
575	<b>Insurer's invoice</b>	Document/message issued by an insurer specifying the cost of an insurance which has been effected and claiming payment therefore	380	Invoice
623	<b>Forwarder's invoice</b>	Invoice issued by a freight forwarder specifying services rendered and costs incurred and claiming payment therefore.	380	Invoice

# Restricting code lists

## Specific code lists for the invoice

### Invoice Type Code

<b>Document location</b>	cbc:InvoiceTypeCode
<b>Source codelist</b>	<a href="#">Subset of UN/CEFACT code list 1001, D.16B</a>

Table 8. Code list

Code	Name	Description
380	<b>Commercial invoice</b>	Document/message claiming payment for goods or services supplied under conditions agreed between seller and buyer.
393	<b>Factored invoice</b>	Invoice assigned to a third party for collection.
82	<b>Metered services invoice</b>	Document/message claiming payment for the supply of metered services (e.g., gas, electricity, etc.) supplied to a fixed meter whose consumption is measured over a period of time.
80	<b>Debit note related to goods or services</b>	Debit information related to a transaction for goods or services to the relevant party.
84	<b>Debit note related to financial adjustments</b>	Document/message for providing debit information related to financial adjustments to the relevant party.
395	<b>Consignment invoice</b>	Commercial invoice that covers a transaction other than one involving a sale.
575	<b>Insurer's invoice</b>	Document/message issued by an insurer specifying the cost of an insurance which has been effected and claiming payment therefore
623	<b>Forwarder's invoice</b>	Invoice issued by a freight forwarder specifying services rendered and costs incurred and claiming payment therefore.

## Specific code lists for the credit note

### Credit note Type Code

<b>Document location</b>	cbc:CreditNoteTypeCode
<b>Source codelist</b>	<a href="#">Subset of UN/CEFACT code list 1001, D.16B</a>

Table 9. Code list

Code	Name	Description	Synonym with	UBL Message type
381	<b>Credit note</b>	Document/message for providing credit information to the relevant party.		CreditNote
396	<b>Factored credit note</b>	Credit note related to assigned invoice(s).	381	CreditNote
81	<b>Credit note related to goods or services</b>	Document message used to provide credit information related to a transaction for goods or services to the relevant party.	381	CreditNote
83	<b>Credit note related to financial adjustments</b>	Document message for providing credit information related to financial adjustments to the relevant party, e.g., bonuses.	381	CreditNote
532	<b>Forwarder's credit note</b>	Document/message for providing credit information to the relevant party.	381	CreditNote

380	Invoice
-----	---------

# Documentation of the restrictions

## Appendix A: Restrictions on EN16931

Below is a list of the restrictions on [EN 16931](#) that is done in this Core Invoice Usage Specification (CIUS).

All restrictions are within the allowed specifications in a Core Invoice Usage Specification (CIUS), as listed in chapter 7.3.2 in [EN 16931](#).

### A.1. Restrictions for profile 01 - Billing

BT-ID	Business Term	Restriction Type	Description	Rule
BT-3	Invoice type code	Mark defined values as not allowed	Allowed set of values can be found in <a href="#">Invoice Type Code</a>	PEPPOL-EN16931-P0100, PEPPOL-EN16931-P0101

### A.2. Restrictions on the invoice and credit note transaction

BT-ID	Business Term	Restriction Type	Description	Rule
BT-2, BT-7, BT-9, BT-26, BT-72, BT-73, BT-74, BT-134, BT-135	All date elements	Add new non-conflicting business rule to existing element(s)	A date shall be formatted YYYY-MM-DD	PEPPOL-EN16931-F001

# Documentation of the restrictions

## Appendix A: Restrictions on EN16931

Below is a list of the restrictions on [EN 16931](#) that is done in this Core Invoice Usage Specification (CIUS).

All restrictions are within the allowed specifications in a Core Invoice Usage Specification (CIUS), as listed in chapter 7.3.2 in [EN 16931](#).

### A.1. Restrictions for profile 01 - Billing

BT-ID	Business Term	Restriction Type	Description
BT-3	Invoice type code	Mark defined values as not allowed	Allow <a href="#">Type</a>

### A.2. Restrictions on the invoice and credit note

BT-ID	Business Term	Restriction Type	Description
BT-2 , BT-7 , BT-9 , BT-26, BT-72, BT-73, BT-74, BT-134, BT-135	All date elements	Add new non-conflicting business rule to existing element(s)	A date shall be form

### A.3. Restrictions on the supported processes

Chapter 5.2 in the [EN 16931](#) defines the business processes supported by the [EN 16931](#).

This Core Invoice Usage Specification (CIUS) has made restrictions to not explicitly support the following business processes:

#### **P10 - Corrective invoicing**

The process as described for corrective invoicing was seen as unclear as to the differentiating between a corrective invoice and a credit note, and this process was set to be out of scope.

#### **P11 - Partial and final invoicing**

Due to the fact that partial and final invoices does not require all information that is mandated, this process is out of scope for this PEPPOL BIS.

#### **P12 - Self billing**

Directive 2006/112/EC (Article 224) requires a specific process to be observed, involving prior agreement and a procedure where the supplier is to accept each invoice. Self-billing requires a specific set-up due to the requirements for prior agreement and procedure for the acceptance of each self-bill. Specific milestones have to be observed at time of setting it up as well as in the operation of self-billing.

# General rules and country-qualified rules

- A **general rule** applies for all invoices
  - The rule is triggered by the existence of a specific business term

## Rule text from the standard

In an Invoice line where the Invoice item VAT category code (BT-151) is "Export outside the EU" the Invoiced item VAT rate (BT-152) shall be 0 (zero).

## Context (what triggers the rule)

Existence of

***InvoiceLine/Item/ClassifiedTax/CategoryCode='XYZ'***

## Example rule text from a CIUS

The Seller Name must not have more than 50 characters

## Context (what triggers the rule)

Existence of

***Seller/Name***

- A **country-qualified rule** applies only for invoices issued in a specific country
  - The rule is triggered by the given country code of the seller

## Example rule text from a Country specific CIUS

When the Seller is Swedish, the Legal Registration Number must be numeric with 10 digits.

## Context (what triggers the rule)

Existence of

***Seller/Address/CountryCode='SE'***

***AND existence of***

***Seller/LegalRegistrationNumber***

# Layers of validation rules in PEPPOL

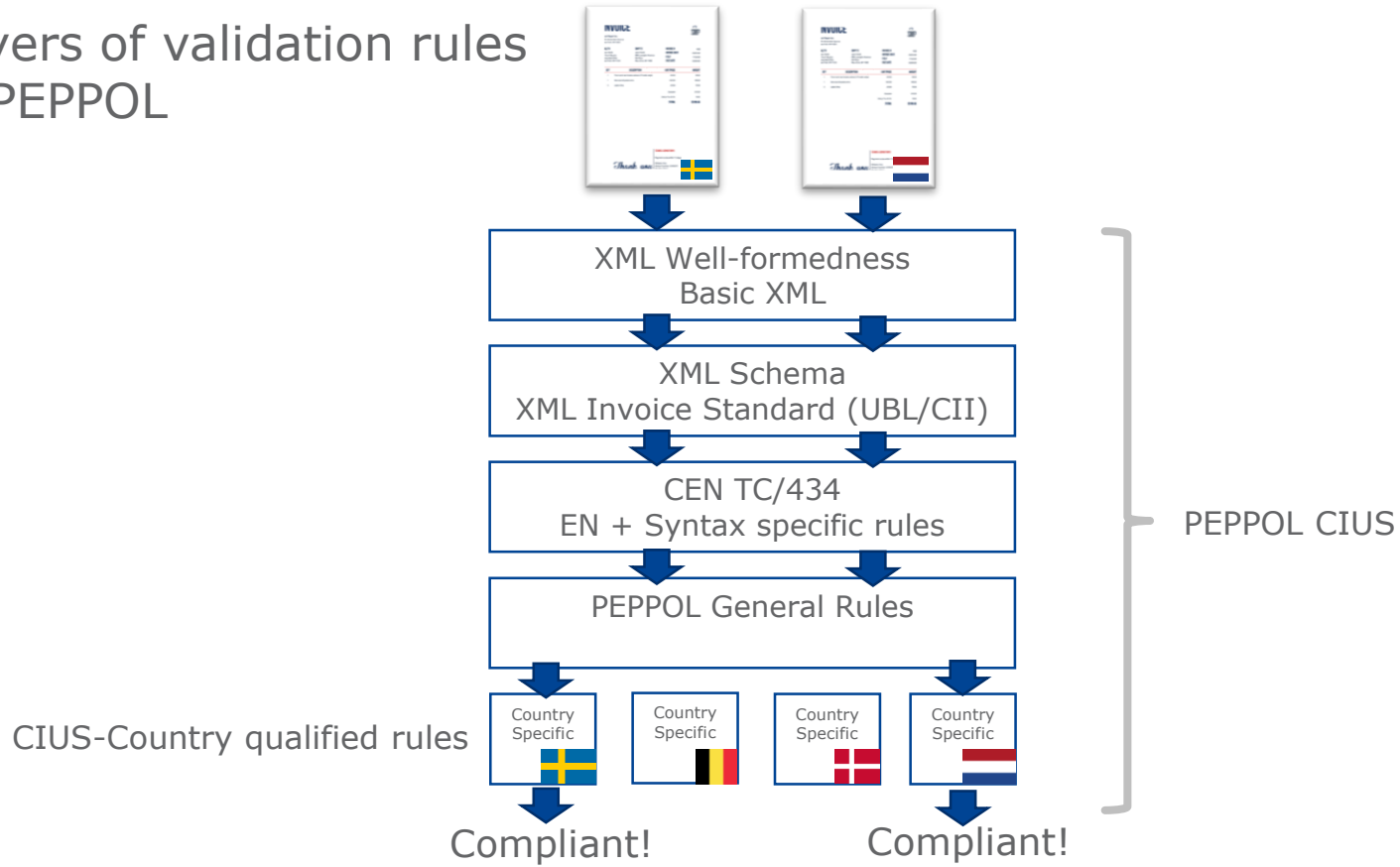

# National rules

To avoid creation of national CIUS'es:

- affected based on the country of the seller.
- Don't affect invoices issued in other countries.
- PEPPOL Authority responsible

## Appendix C: National rules

The following rules have been defined by PEPPOL Authorities in addition to the rules for [PEPPOL BIS](#) in general. These rules are affected based on the country of the seller, and **will not affect invoices issued in other countries.** They apply in **all** profiles that use this transaction specification.

National rules are provided by each country's PEPPOL Authority, and if you need any changes or additions to these rules, please contact your PEPPOL Authority.

*Table 18. National transaction business rules*

Rule	Message/Context/Test
DK-R-001 (warning)	<b>For Danish suppliers when the Accounting code is known, it should be referred on the Invoice.</b>
	ubl-creditnote:CreditNote   ubl-invoice:Invoice
	not(cac:AccountingSupplierParty/cac:Party/cac:PostalAddress/cac:Country/cbc:IdentificationCode = 'DK' and (normalize-space(cbc:AccountingCost/text()) = ''))
DK-R-002 (fatal)	<b>Danish suppliers MUST provide legal entity (CVR-number).</b>
	ubl-creditnote:CreditNote   ubl-invoice:Invoice
	not(cac:AccountingSupplierParty/cac:Party/cac:PostalAddress/cac:Country/cbc:IdentificationCode = 'DK' and (normalize-space(/cac:AccountingSupplierParty/cac:Party/cac:PartyLegalEntity/cbc:CompanyID/text()) = ''))

# Swedish rules

- Formats for VAT and organisation numbers
- Swedish VAT rates
- Tax registration F-Skatt
- Payment means Bankgiro and Plusgiro

<b>SE-R-001</b> For Swedish suppliers, Swedish VAT-numbers must consist of 14 characters.	<b>fatal</b>
<b>SE-R-002</b> For Swedish suppliers, the Swedish VAT-numbers must have the trailing 12 characters in numeric form	<b>fatal</b>
<b>SE-R-003</b> Swedish organisation numbers should be numeric.	<b>fatal</b>
<b>SE-R-004</b> Swedish organisation numbers consist of 10 characters.	<b>fatal</b>
<b>SE-R-005</b> For Swedish suppliers, when using Seller tax registration identifier, 'Godkänd för F-skatt' must be stated	<b>fatal</b>
<b>SE-R-006</b> For Swedish suppliers, only standard VAT rate of 6, 12 or 25 are used	<b>fatal</b>
<b>SE-R-007</b> For Swedish suppliers using Plusgiro, the Account ID must be numeric	<b>warning</b>
<b>SE-R-008</b> For Swedish suppliers using Bankgiro, the Account ID must be numeric	<b>warning</b>
<b>SE-R-009</b> For Swedish suppliers using Bankgiro, the Account ID must have 7-8 characters	<b>warning</b>
<b>SE-R-010</b> For Swedish suppliers using Plusgiro, the Account ID must have 2-8 characteres	<b>warning</b>
<b>SE-R-011</b> For Swedish suppliers using Swedish Bankgiro or Plusgiro, the proper way to indicate this is to use Code 30 for PaymentMeans and FinancialInstitutionBranch ID with code SE:BANKGIRO or SE:PLUSGIRO	<b>warning</b>



# Example of Swedish use of the EN - Supplier

```
<cac:AccountingSupplierParty>
  <cac:Party>
    <cbc:EndpointID schemeID="0007">5566778899</cbc:EndpointID>
    <cac:PostalAddress>
      <cbc:StreetName>Storgatan 1</cbc:StreetName>
      <cbc:CityName>Stockholm</cbc:CityName>
      <cbc:PostalZone>11122</cbc:PostalZone>
      <cac:Country>
        <cbc:IdentificationCode>SE</cbc:IdentificationCode>
      </cac:Country>
    </cac:PostalAddress>
    <cac:PartyTaxScheme>
      <cbc:CompanyID>Godkänd för F-skatt</cbc:CompanyID>
      <cac:TaxScheme>
        <cbc:ID>TAX</cbc:ID>
      </cac:TaxScheme>
    </cac:PartyTaxScheme>
    <cac:PartyTaxScheme>
      <cbc:CompanyID>SE123456789001</cbc:CompanyID>
      <cac:TaxScheme>
        <cbc:ID>VAT</cbc:ID>
      </cac:TaxScheme>
    </cac:PartyTaxScheme>
    <cac:PartyLegalEntity>
      <cbc:RegistrationName>Allsälj AB</cbc:RegistrationName>
      <cbc:CompanyID schemeID="0007">1234567890</cbc:CompanyID>
      <cbc:CompanyLegalForm>Säte: Stockholm</cbc:CompanyLegalForm>
    </cac:PartyLegalEntity>
  </cac:Party>
</cac:AccountingSupplierParty>
```

1

2

3

- End point ID
- F-Skatt
- Name of supplier

## Example of Swedish use of the EN – Payment means

```
<cac:PaymentMeans>  
  <cbc:PaymentMeansCode>30</cbc:PaymentMeansCode> 1  
  <cbc:PaymentID>Meddelande</cbc:PaymentID>  
  <cac:PayeeFinancialAccount>  
    <cbc:ID>123456</cbc:ID>  
    <cbc:Name>Account name</cbc:Name>  
    <cac:FinancialInstitutionBranch>  
      <cbc:ID>SE:PLUSGIRO</cbc:ID> 2  
    </cac:FinancialInstitutionBranch>  
  </cac:PayeeFinancialAccount>  
</cac:PaymentMeans>
```

- Only one payment means code allowed
- Type of giro signified by code SE:BANKGIRO and SE:PLUSGIRO

```
<cac:PaymentMeans>  
  <cbc:PaymentMeansCode>30</cbc:PaymentMeansCode> 1  
  <cbc:PaymentID>Meddelande</cbc:PaymentID>  
  <cac:PayeeFinancialAccount>  
    <cbc:ID>123456</cbc:ID>  
    <cbc:Name>Account name</cbc:Name>  
    <cac:FinancialInstitutionBranch>  
      <cbc:ID>SE:BANKGIRO</cbc:ID> 3  
    </cac:FinancialInstitutionBranch>  
  </cac:PayeeFinancialAccount>  
</cac:PaymentMeans>
```

Warning! Risk for errors:

[http://test-docs.peppol.eu/poacc/billing/3.0/bis/#\\_payment\\_by\\_post\\_or\\_bank\\_giro](http://test-docs.peppol.eu/poacc/billing/3.0/bis/#_payment_by_post_or_bank_giro)

---

## Useful links

- Documentation: <http://docs.peppol.eu/poacc/billing/3.0/>
  - Business Implementation Guide
  - Syntax mapping
  - Rules
  - Migration plan
- Source(GitHub): <https://github.com/OpenPEPPOL/peppol-bis-invoice-3>
  - Source file used for the BIS
  - Example files
  - Schematron files



# The Swedish implementation of the EU directive

---

## Bakgrund till krav på e-faktura vid all offentlig upphandling

- Bra med lagkrav för att realisera de nyttor som finns
- Olika typer av stöd behövs under ett flertal år
- E-faktura är hanterbart för små företag
- En bred samsyn om att tiden är mogen



se tidigare utredning av ESV:

<http://www.esv.se/2/Press/Nyheter-och-pessmeddelanden/2015/bra-att-infora-lagkrav-pa-e-faktura-till-offentlig-sektor/>

# Offentlig sektor är väl förberedda inför nya lagen om e-faktura

- Alla myndigheter tar emot och skickar e-faktura sedan 2008
  - Andel e-faktura 63%
  - Nästan 100% anslutna till PEPPOL
- Nästan alla kommuner och landsting har infört e-faktura och e-handel på frivillig basis
  - Andel e-faktura drygt 50 %
  - E-faktura infört av 87% av kommuner\* och alla landstingen

\* enligt enkät 2016/17, nu infört i fler



## Lagen om e-fakturering till följd av offentlig upphandling

- Riksdagsbeslut 14 juni 2018
- De fakturer som en leverantör utfärdar till en upphandlande myndighet eller enhet ska vara elektroniska och överensstämma med den Europeiska standarden för elektronisk fakturering, om inte någon annan standard avtalats (4 §).
- Upphandlande myndigheter och enheter är skyldiga att ta emot och behandla fakturer som överensstämmer med den Europeiska standarden för e-fakturering (5§).

## Lagen om e-fakturering till följd av offentlig upphandling

Vilka omfattas då?

- Definitioner av upphandlande myndigheter och enheter i enlighet med upphandlingslagarna (LOU, LUFS och LUK)
- Omfattar alltså myndigheter, kommuner, landsting och regioner samt kommunala bolag (enl. def med avgörande inflytande mm)

*Fakturorna ska ha utfärdats, översänts och mottagits i strukturerat elektroniskt format som gör det möjligt att behandla dem automatiskt och elektroniskt.*

*PDF faktura anses inte vara en elektronisk faktura.*



## Lagen om e-fakturering till följd av offentlig upphandling

- Kravet på e-fakturering omfattar alla fakturor som en leverantör utfärdar till upphandlande myndigheter och enheter, oavsett hur upphandlingen har gått till.
- Alla inköp omfattas, även köp över disk så snart en faktura är inblandad; kontant betalning i butik omfattas dock inte.
- Med kontant betalning jämförs kortbetalning

## Lagen om e-fakturering till följd av LOU

- Upphandlande myndigheter och enheter har en skyldighet att ta emot e-fakturer som uppfyller den Europeiska standarden.
- Det sägs vidare att *som huvudregel* ska e-fakturorna överensstämma med den Europeiska standarden.
- *Redan etablerade fakturaflöden* mellan leverantörer och upphandlande myndigheter och enheter kan finnas som inte överensstämmer med den Europeiska standarden, men det inte är kostnadseffektivt att byta till denna.
- Därför finns det en möjlighet för parterna att *avtala om annan standard för e-fakturering*.

# Undantag enligt lagen och viten

## Undantag:

Bestämmelserna i lagen ska inte tillämpas i de fall användande av e-faktura skulle innebära risk för

- Röjande av uppgifter som omfattas av sekretess, eller
- Skada för säkerhetskänslig verksamhet

## Vite:

Myndighet som regeringen bestämmer ges rätt att vid vite förelägga en leverantör som

- skickar pappersfakturor eller
- elektroniska fakturor som inte överensstämmer med den europeiska standarden för e-fakturerings att skicka e-fakturor i enlighet med standarden, om inte annat avtalats.

## Ikraftträdande

- Upphandlande myndigheter och enheter ska *kunna ta emot e-fakturor från 1 april 2019*.
- För leverantörer som *ska skicka e-fakturor*; lagen träder ikraft 1 april 2019, dock att det gäller enbart fakturor baserade på *upphandlingar som påbörjats efter den 1 april 2019*. Skälet är vikten av förutsebarhet.

## Hur kan offentlig sektor förbereda sig?

Inledningsvis bör ni göra följande:

- Fråga om er systemleverantör (av till exempel ekonomisystem och e-handelstjänst) stödjer [SFTI:s rekommenderade e-fakturastandarder](#) – särskilt PEPPOL BIS Billing 3.
- Anslut er till [PEPPOL-nätverket](#). Fråga eran leverantör av inköpssystem eller ekonomisystem om de redan är en accesspunkt till PEPPOL för er. Kontakta ESV om ni behöver veta mer.
- Informera era leverantörer om de nya lagkraven på e-faktura från 1 april 2019.
- Säkerställ att ni kan erbjuda en fakturaportal till era leverantörer.
- Ställ [krav på e-faktura](#) i era upphandlingar.

## Vad innebär det för varu- och tjänsteleverantörer?

Alla leverantörer till offentlig sektor måste kunna skicka e-fakturer som följer den nya europeiska standarden som etableras i Sverige under 2018. Det kommer att vara en förutsättning för att vinna offentliga upphandlingar som påbörjas efter den 1 april 2019. Var uppmärksam på upphandlingskrav om e-faktura och efterfrågad fakturastandard när ni svarar på anbud.

Pdf-fakturer eller inskannade pappersfakturer räknas inte som e-faktura enligt den nya standarden. Om ni använder Svefaktura BIS 5A 2.0 är det ingen stor omställning att gå över till [PEPPOL BIS Billing 3](#) som lever upp till de nya kraven. [PEPPOL-nätverket är förberett för den nya e-fakturan](#).

Ett företag som efter flera påminnelser ändå inte fakturerar enligt de nya lagkraven kan få föreläggande om att betala vitesbelopp.

## Hur kan leverantörer till offentlig sektor förbereda sig?

Inledningsvis bör ni göra följande:

- Fråga om er leverantör av ekonomisystem eller fakturerings tjänst kan hantera e-faktura enligt [SFTI:s rekommendationer](#) – särskilt PEPPOL BIS Billing 3.
- Verifiera er e-faktura via [SFTI:s tjänst](#).
- Fråga om er ekonomisystemleverantör eller er operatörtjänst kan ansluta er till [PEPPOL](#), som är ett europeiskt nätverk för e-handel som säkerställer att ni lever upp till kraven i lagförslaget.
- Fråga om era offentliga kunder har en fakturaportal, vilket är ett alternativ för att klara lagkraven om ni bara skickar ett fåtal fakturer till offentlig sektor.

# Migreringsplan e-fakturaformat

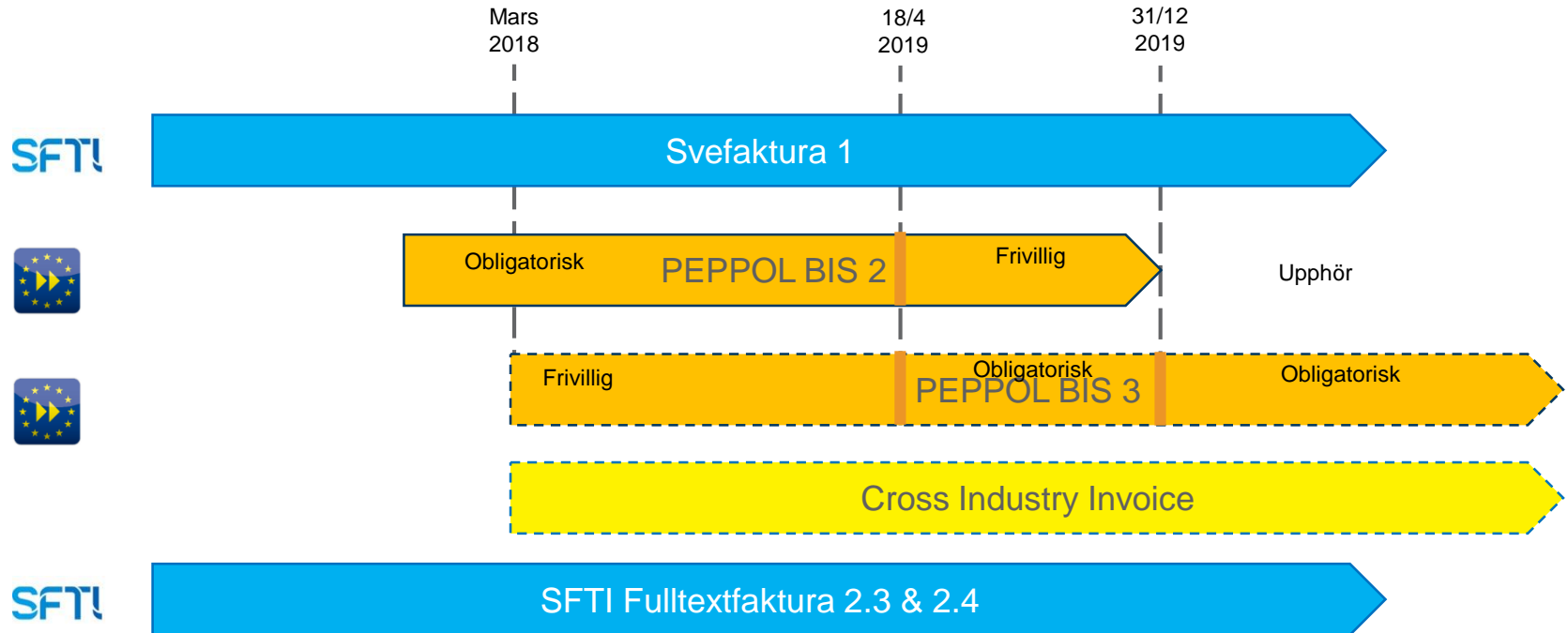



---

# Funding and Grants – possibilities within CEF

---

**Christian Rasmussen**  
DIGIT

## 2018 CEF Telecom calls

Call	Indicative budget	Launch date	Deadline
<u><b>CEF-TC-2018-1</b></u> Safer Internet Europeana eID & eSignature	€18 million €4 million €7.5+0.5 million	22 February 2018	15 May 2018
<u><b>CEF-TC-2018-2,3,5</b></u> Automated Translation eDelivery eInvoicing Public Open Data Cvber Security	€5 million €0.5 million <b>€5 million</b> €18.5 million €13 milion	2 May 2018 2 May 2018 <b>2 May 2018</b> 2 May 2018 2 May 2018	September 2018 September 2018 <b>September 2018</b> November 2018 November 2018
<u><b>CEF-TC-2018-4</b></u> eHealth eProcurement Online Dispute Resolution European Justice Portal	€5 million €3 million €0.4 million €4 million	June 2018	November 2018



---

# 2018-2 eInvoicing call

(2018 Work Programme)

---

## 2018-2 eInvoicing call

**Launch date**

2 May 2018

**Deadline**

September 2018

**Who can apply?/Consortium composition**

Minimum 2 private or public entities from one or several Member States

**Budget**

€5 million

**Co-financing**

75% of the eligible costs

**Indicative duration**

12 months

---

---

## Scope of the last call:

- **Proposals must meet objective 1 or 2:**

**1. Uptake of eInvoicing solutions compliant with the EN and its ancillary deliverables by public entities**

**2. Update of eInvoicing solutions compliant with the EN and its ancillary deliverables by solution providers and public authorities**

- **Promotion of eDelivery:**

Deployment of the eDelivery Building Block or use of eDelivery through a service provider

Must be carried out in conjunction with objective 1 or 2

---

## 2018-2 eInvoicing call: **expected outcomes**

Increased uptake and use of eInvoicing by public authorities (especially regional/local) in meeting the requirements of the eInvoicing Directive

Support for service providers in making their existing solutions compliant with the requirements of the eInvoicing Directive

<b><u>CEF Telecom 2018-2</u></b>	<b><u>Proposals received</u></b>	<b><u>Requested budget</u></b>	<b><u>Available budget</u></b>	<b><u>Oversubscription rate</u></b>
Automated Translation	11	€8,964,037	€5,000,000	1.79
eDelivery	5	€829,330	€500,000	1.66
eInvoicing	19	€8,238,483	€5,000,000	1.65
<b>Total</b>	<b>35</b>	<b>€18,031,850</b>	<b>€10,500,000</b>	<b>1.72</b>

**Past eInvoicing calls**

---

## 2015-1 eInvoicing call

- Call opening: 15 September 2015 - Call closure: 11 February 2016
- **Call objective:**
- Increase uptake and the use of the eInvoicing DSI by supporting authorities – especially at the regional and local levels – in meeting the requirements of the eInvoicing Directive
- **Overall indicative budget: €7 million**
- **Co-funding rate:** 75% of eligible costs
- **Proposals received: 10**
- **Eligible proposals received: 8**
- **Grant agreements: 8**
- **Maximum EU contribution: €4,426,111**
- **1 action** already completed
- **7 actions** on-going (all aiming to implement European eInvoicing standard), supporting:
  - Solution providers (AT - ecasio, ES - EDICOM, UK - ELCOM) in upgrading their solution to the eInvoicing standard + supporting users of the solutions
  - Uptake and upgrade of national eInvoicing platforms (CY, HR, ES, IT)
  - Tool for eInvoicing format mapping (NL, DE)

# 2015-1 eInvoicing call: Member States involved (13)

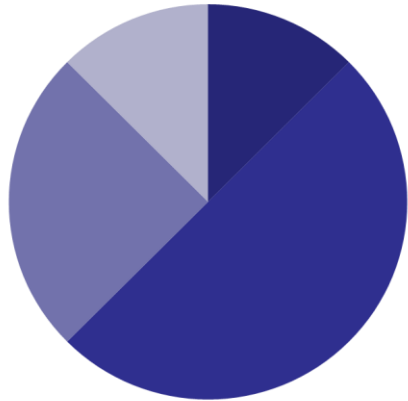

- 5 members (1 consortium)
- 6 members (4 consortia)
- 7 members (2 consortia)
- 8 or more members (1 consortium)

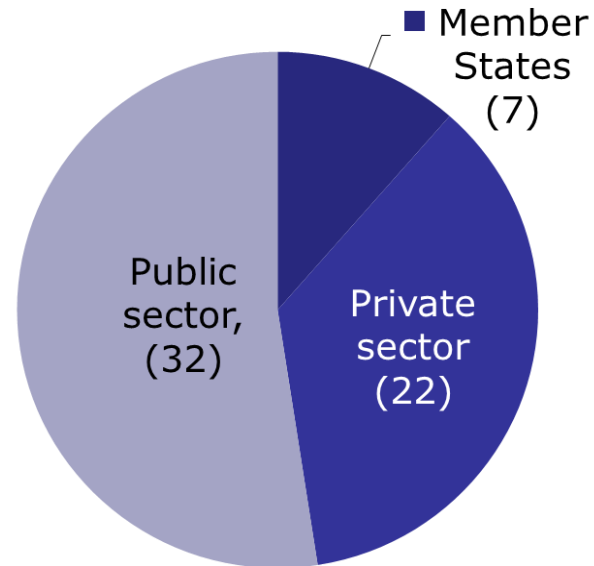

---

## 2016-3 eInvoicing call

- Call opening: 13 September 2016 - Call closure: 15 December 2016
- **Call objective:**
- Increase uptake and the use of the eInvoicing DSI by supporting authorities – especially at the regional and local levels – in meeting the requirements of the eInvoicing Directive
- **Overall indicative budget: €7 million**
- **Co-funding rate:** 75% of eligible costs
- **Proposals received: 21**
- **Eligible proposals received: 20**
- **Recommended proposals: 15**
- **Recommended funding: €10,401,818**
- Info below still indicative: grant agreement preparation now on-going (to be finalised by mid-September)
- Most of the actions to start between May and September 2017 and run until end of 2018
  - All will ensure the compliance with the European eInvoicing standard
  - Most will also deploy eDelivery
- Actions will support:
  - Solution providers and national eInvoicing solutions, including at the local level, to make them compliant with eInvoicing standard
  - Strong focus of some of the actions on onboarding suppliers and engaging with SMEs



# 2016-3 eInvoicing call

## Member States involved (22)

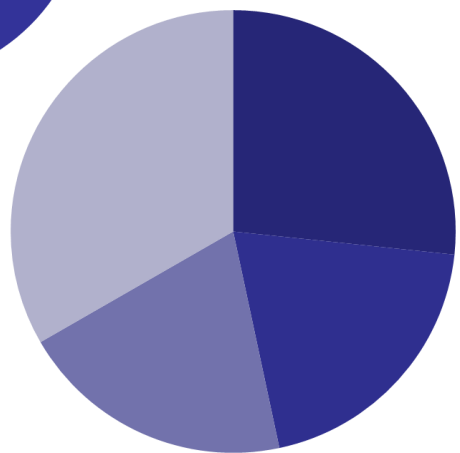
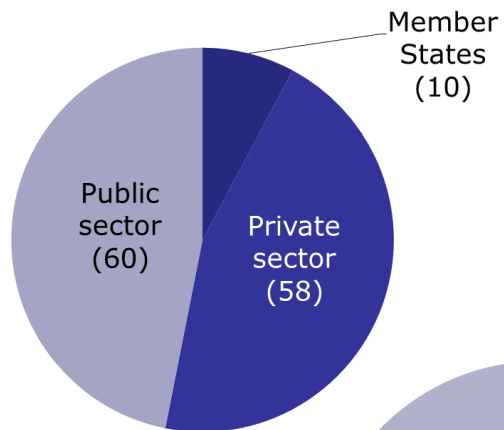

- 5 members (4 consortia)
- 6 members (3 consortia)
- 7 members (3 consortia)
- 8 or more members (5 consortia)



---

## 2017-3 eInvoicing call

- Call opening: 28 June 2017 - Call closure: 28 November 2017
- **Call objective:**
- Increase uptake and the use of the eInvoicing DSI by supporting authorities – especially at the regional and local levels – in meeting the requirements of the eInvoicing Directive
- **Overall indicative budget: €10 million**
- **Co-funding rate:** 75% of eligible costs
- **Proposals received: 23**
- **Eligible proposals received: 21**
- **Recommended proposals: 10**
- **Recommended funding: €8,800,000**
- Info below still indicative: grant agreement preparation will start in May 2018
- Most of the actions to start between May and September 2018 and run until end of 2019
  - All will ensure the compliance with the European eInvoicing standard
  - Most will also deploy eDelivery
- Actions will support:
  - Solution providers and national eInvoicing solutions, including at the local level, to make them compliant with eInvoicing standard
  - Strong focus of some of the actions on onboarding suppliers and engaging with SMEs

# 2017-3 eInvoicing call

## Member States involved (16)

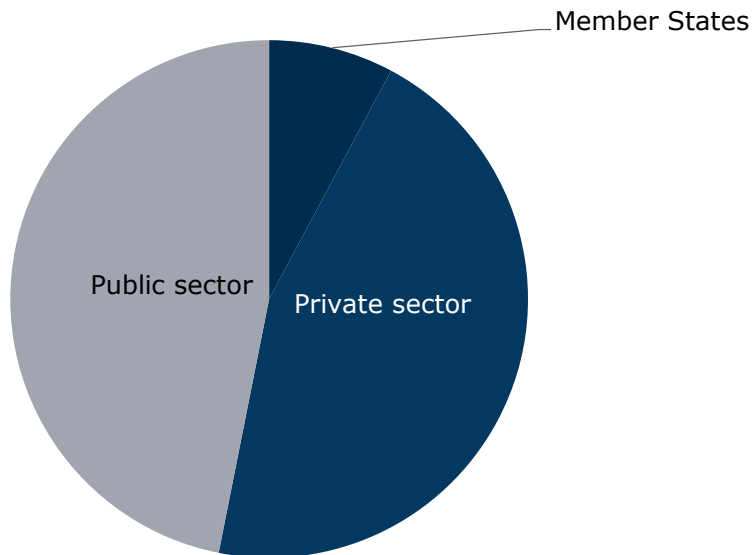

## Member States Number of projects and CEF funding (€ thousand)

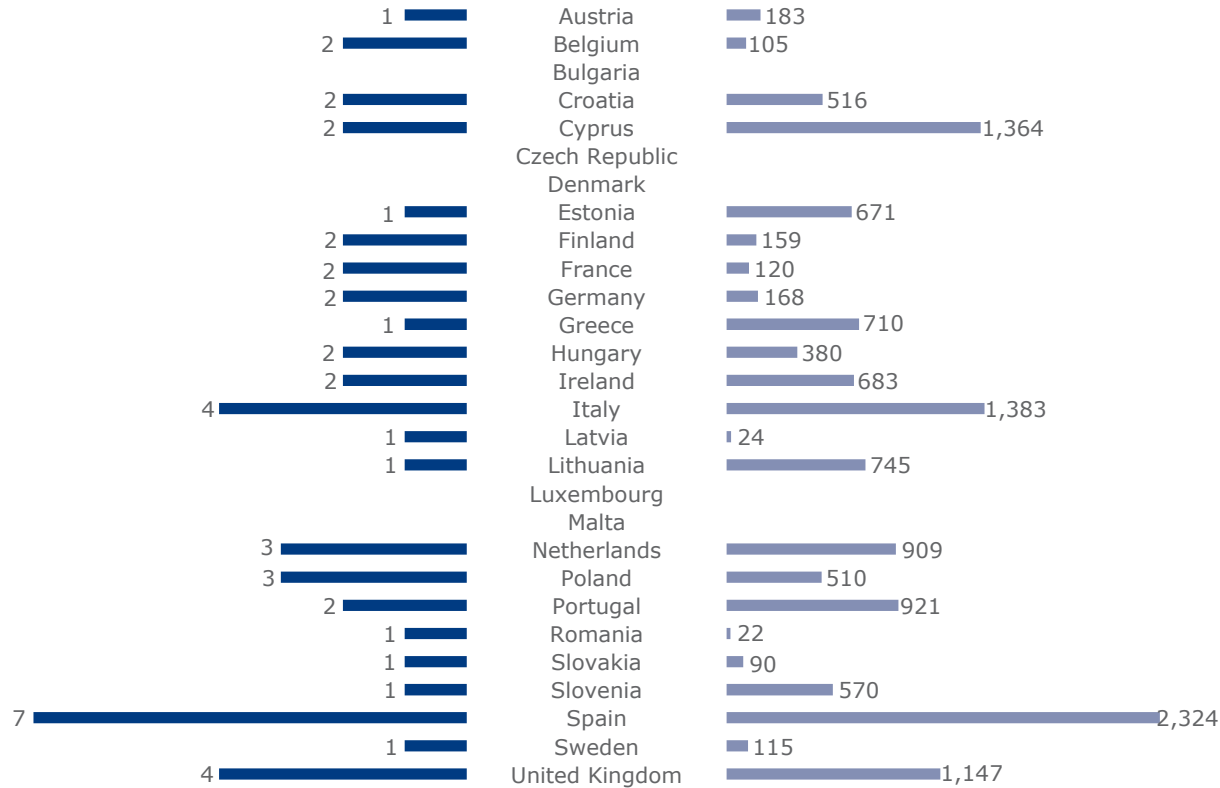

## EEA and Third Countries Number of projects and CEF funding (€ thousand)

1 Norway 714

# CEF Telecom 2014-2016

## List of grant agreements for eInvoicing DSI building blocks

Project Code	Title	Beneficiary countries	Start Date	End Date	Project Status	CEF funding for the action (€)
2015-AT-IA-0049	EVA - e-Invoicing for Austria	AT	01/09/2016	31/12/2017	Ongoing	183,000
2015-CY-IA-0052	E-invoicing Cyprus	CY	01/10/2016	31/12/2017	Ongoing	561,430
2015-ES-IA-0055	SMART eINVOICING PLATFORM TO ENFORCE CROSS-BORDER DOCUMENTATION EXCHANGE (SEINPEX)	ES	01/08/2016	31/12/2017	Ongoing	222,781
2015-EU-IA-0050	eIGOR - eInvoicing GO Regional	IT,UK	01/01/2017	31/12/2017	Ongoing	1,252,500
2015-EU-IA-0054	Semantic conversion of business documents (SCOBDO)	DE,NL	01/09/2016	31/12/2017	Ongoing	283,199
2015-EU-IA-0058	GOVeIn European eInvoicing Project: implementation of the European electronic invoice within the Public Health area	ES,FR,HU,IE,IT,NL,PL,RO,UK	01/10/2016	31/10/2017	Ongoing	770,249
2015-HR-IA-0048	Croatian eInvoicing Business-to-Administration Exchange Project	HR	02/06/2016	30/05/2017	Closed	251,328
2015-UK-IA-0056	eInvoice Expansion	UK	01/10/2016	31/12/2017	Ongoing	901,624
2016-CY-IA-0105	Cy e-Invoicing (Local Authorities)	CY	01/01/2018	31/12/2018	Ongoing	802,134
2016-EL-IA-0130	Interoperable eInvoicing in Greece (GRInv)	EL	01/10/2017	30/09/2018	Ongoing	710,065
2016-ES-IA-0117	FACe - The core platform of the Spanish public authorities to process the European standard on electronic invoice	ES	01/09/2017	30/11/2018	Ongoing	298,691
2016-ES-IA-0134	EUeInvoicing.cat - European standards adoption for eInvoicing in Catalonia	ES	01/09/2017	31/08/2018	Ongoing	622,833
2016-EU-IA-0086	Tools and support towards the adoption of the future EN on electronic invoicing in SMEs	BE,ES,IT	01/09/2017	31/08/2018	Ongoing	372,054
2016-EU-IA-0096	GOV2EU - Supporting public entities to adopt EU Standard on electronic invoice for cross-border transactions	BE,DE,ES,FR,HU,IT,PL,PT,SK	01/09/2017	31/10/2018	Ongoing	1,248,208
2016-EU-IA-0109	SAPHeIN – Implementing SAPHetydoc for the wide adoption of eInvoicing	ES,PT	01/06/2017	31/08/2018	Ongoing	908,837
2016-EU-IA-0119	Facilitate and increase the use of the European Norm on e-invoice and the use of access point in the EU	FI,NO,SE	15/12/2016	01/06/2018	Ongoing	887,879
2016-EU-IA-0120	Internet of Business (IoB)	EE,FI,LV	01/06/2017	31/05/2018	Ongoing	795,248
2016-EU-IA-0126	Promote uptake of e-invoicing in Ireland	IE,UK	01/07/2017	30/06/2018	Ongoing	755,904
2016-HR-IA-0090	eINVOICING For Croatian Public Authorities (eICPA)	HR	19/09/2017	19/09/2018	Ongoing	264,201
2016-LT-IA-0104	eInvoicing cross-border LT	LT	01/09/2017	01/09/2018	Ongoing	744,553
2016-NL-IA-0088	NL eInvoicing	NL	16/12/2016	31/05/2018	Ongoing	705,068
2016-PL-IA-0106	European cross-border e-invoice in local public procurement in Poland	PL	01/10/2017	30/11/2018	Ongoing	420,442
2016-SI-IA-0103	Readiness of Slovenian E-invoicing	SI	01/06/2017	01/06/2018	Ongoing	570,248

---

How to apply:

**READ** all call documentation carefully; forms, Guide for Applicants, FAQs, call webpage

**REFLECT** on the call content & requirements

**REMEMBER** that successful applications take time and effort, but guidance is available!

---

CEF Telecom calls:  
for more information



**[inea-cef-telecom-calls@ec.europa.eu](mailto:inea-cef-telecom-calls@ec.europa.eu)**



**<https://ec.europa.eu/inea/en/connecting-europe-facility/cef-telecom/apply-funding/2017-cef-telecom-calls-proposals>**



**[@inea\\_eu](https://twitter.com/inea_eu)**

**Lessons learned**

**QUESTIONS?**





European  
Commission



---

# Workshops

---

---

# Workshop

- 2 x omgångar 20 minuter diskussion i grupper + 20 uppsummering
- Lokal: Detta rummet, rummet bredvid (Saga 3) och ute i loungen
- Grupper om 6 personer
- Workshop 1 – Utmaningar och möjligheter kring det Svenska införandet
- Workshop 2 - Utmaningar och möjligheter kring standarden för e-faktura, tidsaspekten mm.
- Extensions – do you see a big need for this?
- IPR and Copyright
- Cross border aspects – how enable?
- Services that would help implementation?
- Multi syntax, how to handle?
- Invoices and CreditNotes and negative invoices – how will you implement this?
- Validation with schematron – benefits and drawbacks?
- CIUS
- Hur nå ut till små företag på bästa sätt?
- Vilka typer av företag kommer att få störst omställningsutmaningar? Hur stödja?