



The eEvidence Digital Exchange System

Vision for 2031

What is an e-CODEX network?

e-CODEX network

e-Delivery Gateway – Secure Transmission – **DIGIT**

e-CODEX Connector – **eu-LISA** – connects Reference Implementation or National Systems

e-CODEX Access Point = Connector + Gateway
eu-LISA

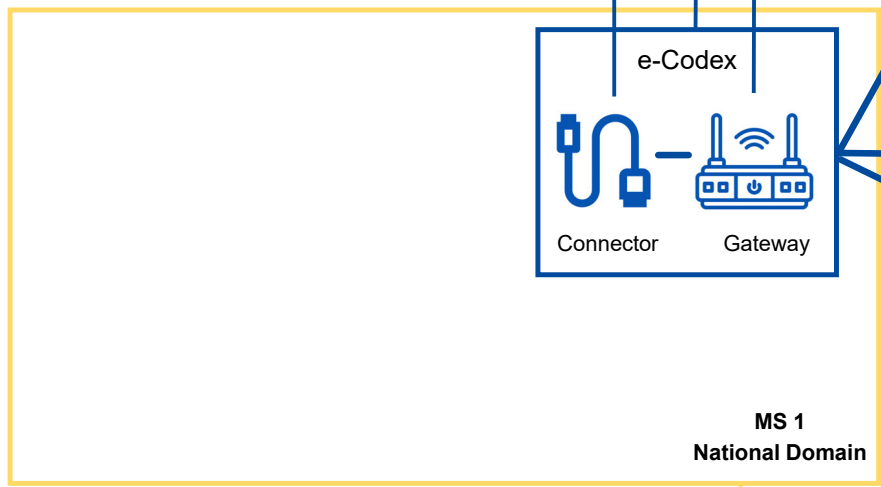

MS Full Responsibility Operations/Maintenance – Support to MS: **eu-LISA**

e-CODEX Regulation

MS Communicate to eu-LISA their Authorized Access Points

eu-LISA – Enrol the APs

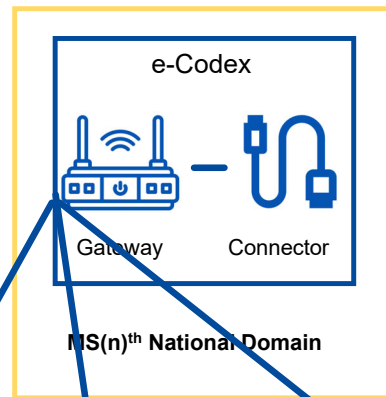

e-CODEX Network = Authorized e-CODEX Access Points by MS

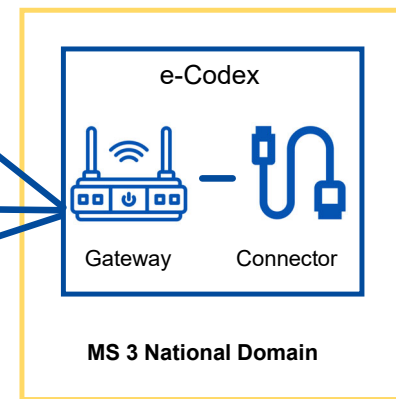
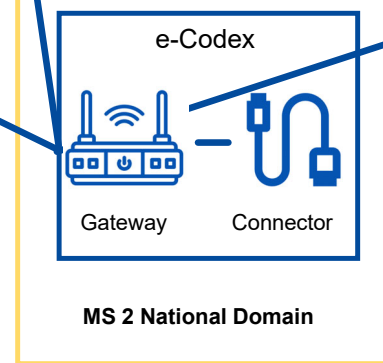



What is a Digital Exchange System?

e-CODEX network

e-CODEX Regulation

e-Delivery Gateway – Secure Transmission – **DIGIT**

e-CODEX Connector – **eu-LISA** – connects Reference Implementation or National Systems

e-CODEX Access Point = Connector + Gateway
eu-LISA

MS Communicate to eu-LISA their Authorized Access Points

eu-LISA – Enrol the APs

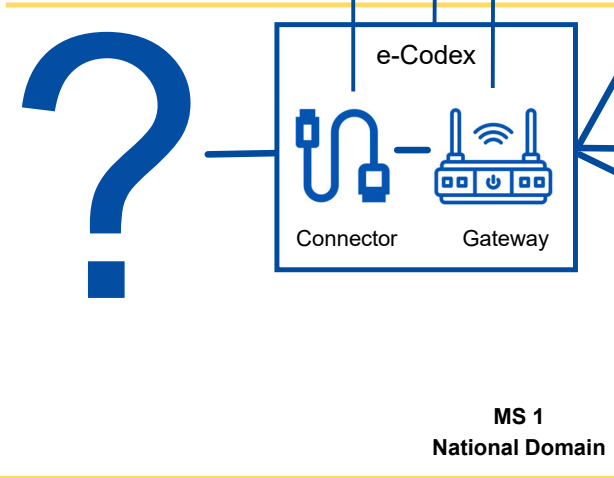
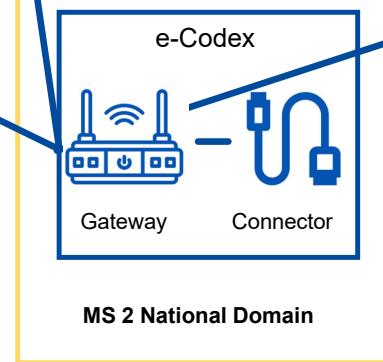
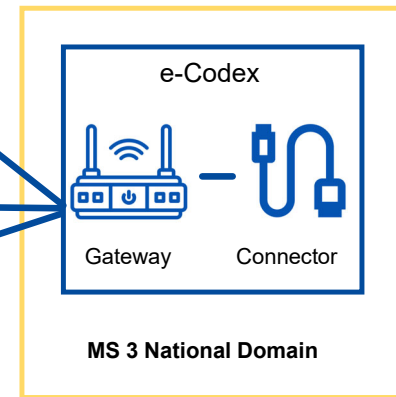
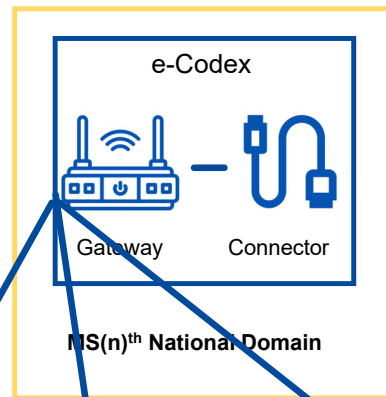

e-CODEX Network = Authorized e-CODEX Access Points by MS

ANEXA
EUROPEAN INVESTIGATION ORDER (EIO)

This EIO has been issued by a requesting authority. The issuing authority certifies that the issuing of this EIO is necessary and proportionate for the purposes of the proceedings identified within it taking into account the rights of the recipient or addressee and that the investigative measures requested could not have been ordered under the same conditions in a similar domestic case. I request that the investigative measure or measures specified below be carried out taking due account of the confidentiality of the investigation and that the evidence obtained as a result of the execution of the EIO be transferred.

SECTION A:
Issuing State: Republic of Poland
Executing state: Czech Republic

SECTION B: Urgency
Please indicate if there is any urgency due to:
 Evidence being concealed or destroyed
 Imminent trial date
 Any other reason
Please specify below:
Time limit for execution of the EIO as laid down in Directive (2014/41/EU). However, if a shorter or specific time limit is necessary, please provide the date and explain the reason for this:
Date: _____ Time (with Time Zone): _____

SECTION C: Investigative measure(s) to be carried out
1. Describe the additional/investigative measure(s) required AND indicate, if applicable, if it is one of the following investigative measures:
Measures
 National investigative measure(s)
 Search
 Seizure (with a view to gathering evidence)
 Surrender of documents
 Surrender of business records
 Obtaining information or evidence already in possession of the receiving authority
 Obtaining information contained in databases held by police or judicial authorities

MS Full Responsibility Operations/Maintenance – Support to MS: eu-LISA



A Digital Exchange System

e-Delivery Gateway – Secure Transmission – **DIGIT**

e-CODEX Connector – **eu-LISA** – connects Reference Implementation or National Systems

e-CODEX Access Point = Connector + Gateway
eu-LISA

User interface, **MS** Develop, Operate, Maintain

ANEXA
EUROPEAN INVESTIGATION ORDER (EIO)

This EIO has been issued by a competent authority. The issuing authority certifies that the issuing of this EIO is necessary and proportionate for the purposes of the proceedings indicated within it taking into account the rights of the suspect/accused and the protection of the rights of the defence. The issuing authority has also certified that the EIO has been issued under the terms of the Convention on Mutual Assistance in Criminal Matters (CMAC) or the Convention on Mutual Assistance in Criminal Matters between the Member States of the European Union (CMAC-EU) or measures specified in it and that the evidence obtained will be used for the purposes of the proceedings indicated within it.

SECTION A

Issuing State: Republic of Poland
Executing state: Czech Republic

SECTION B: Urgency

Please indicate if there is any urgency due to:

- Evidence being concealed or destroyed
- Increased risk of flight
- Any other reason

Please specify below:

Time limits for execution of the EIO are laid down in Directive (2014/41/EU). However, if a shorter or specific time limit is necessary, please provide the date and explain the reason for this:

Date: _____ Time (with Time Zone): _____

SECTION C: Investigative measures(s) to be carried out

1. Describe the investigation measure(s) required AND indicate, if applicable, if it is one of the following investigative measures:

Search

Seizure (with a view to gathering evidence)

Seizure of documents

Seizure of business records

Obtaining information or evidence already in possession of the executing authority

Obtaining information contained in databases held by police or judicial authorities

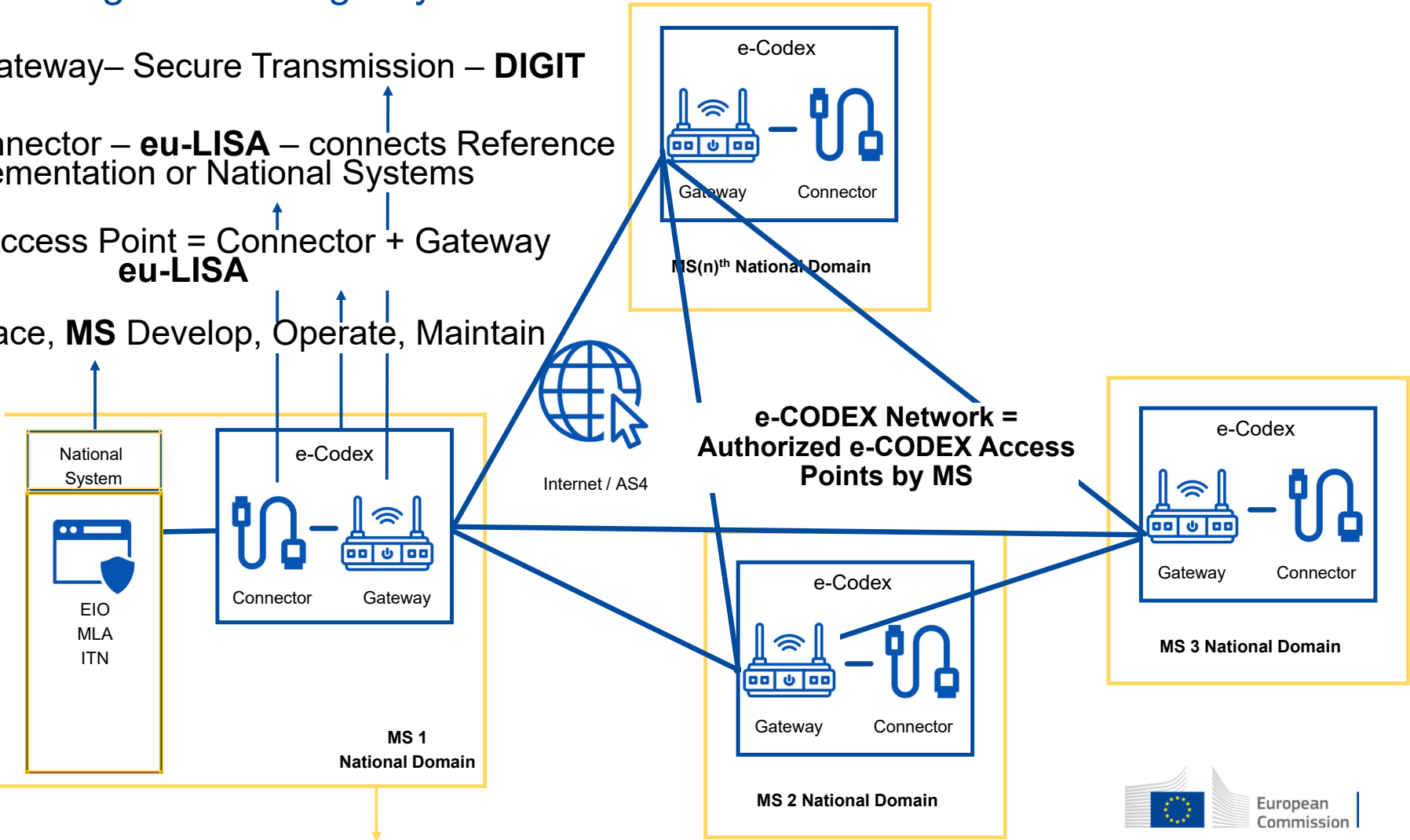

MS Full Responsibility Operations/Maintenance – Support to MS: eu-LISA

A Digital Exchange System

e-Delivery Gateway – Secure Transmission – **DIGIT**

e-CODEX Connector – **eu-LISA** – connects Reference Implementation or National Systems

e-CODEX Access Point = Connector + Gateway
eu-LISA

User interface, **MS** Develop, Operate, Maintain

The screenshot shows a web interface for document submission. It includes a sidebar with navigation options like 'Hääitus', 'Otsingud', 'Pääringud', 'Rahvusvaheline', 'OSA', 'Abitasajad', 'Korduma kippuvad küsimused', and 'Tähti'. The main content area is titled 'Üldandmed' and contains several input fields: 'Tõlgingu kuupäev' (16.10.2023), 'Tõlgingu aeg', 'Tõlgingu meetodid', 'Tõlge LÜÜP', 'Riigikohus', 'Põhja Ringkonnakohturatu', 'Sätestatud / Koostamisel', 'Taotluse teema', and 'Taotlus väljend'. Below this is a section for 'EUROOPA ÜHENDAMÄÄRUS (EÜD)' with a text area and a 'Käesoleva Euroopa sisetähtsuse on koostatud põhiv. asutus või ametlik. Tõlge asutus või ametlik koostab, et käesoleva Euroopa sisetähtsuse koostamine on selles kindlakäetud sisetähtsuse jaoks vajalik ja proportsionaalne, võttes arvesse käsitlatarea või suudatava ligi, ning et teatavate sisetähtsuse tegemist oleks saanud samadel tingimustel teostada samasug. ligi. Tõlge käesoleva järgnevat täpsustatud sisetähtsuse või tõlgete tegemist mille puhul võetakse nõutakse arvesse sisetähtsuse koostamisel, ning Euroopa sisetähtsuse tehakse käigus saadud tõlgete edastamist.' There are also sections for 'Ara kSA järeleand' and 'A OSA', 'B OSA. Kireloomuutus', 'C OSA. Tehtev (ad) uurimistõimingu (ud)', and 'D OSA. Seos varasema Euroopa sisetähtsusega'. At the bottom, there are buttons for 'Looke', 'Salvesta muutused', and 'Mõeldakse seadustamiseks'.

MS Full Responsibility Operations/Maintenance – Support to MS: eu-LISA



Internet / AS4

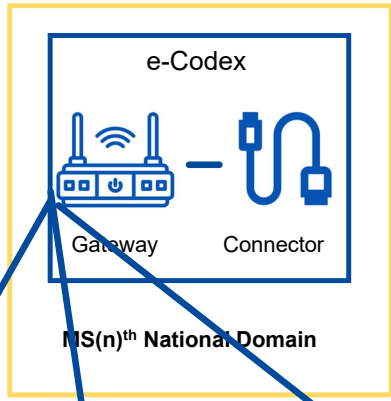

e-CODEX Network = Authorized e-CODEX Access Points by MS

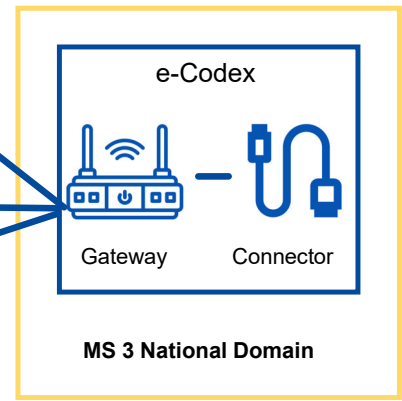
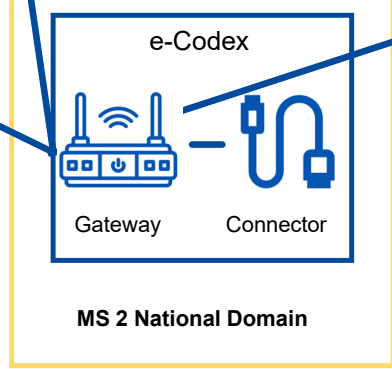

A Digital Exchange System

e-Delivery Gateway – Secure Transmission – **DIGIT**

e-CODEX Connector – **eu-LISA** – connects Reference Implementation or National Systems

e-CODEX Access Point = Connector + Gateway
eu-LISA

User interface, **JUST** Develops, **MS** Operate

ANEXA
EUROPEAN INVESTIGATION ORDER (EIO)

This EIO has been issued by a competent authority. The issuing authority certifies that the issuing of this EIO is necessary and proportionate to the investigation of the proceedings referred to in the title and that the rights of the suspect or accused and of any other persons concerned have been observed under the conditions specified in the EIO or measures specified in the EIO or measures specified in the EIO.

SECTION A

Issuing State: Republic of Poland
Executing state: Czech Republic

SECTION B: Urgency

Please indicate if there is any urgency due to:

Evidence being concealed or destroyed

Increased risk of loss

Any other reason

Please specify below:

Time limit for execution of the EIO as laid down in Directive (2014/41/EU). However, if a shorter or specific time limit is necessary, please provide the date and explain the reason for this:

Date: _____ Time (with Time Zone): _____

SECTION C: Investigative measures to be carried out

1. Describe the additional/investigative measures required AND indicate, if applicable, if it is one of the following investigative measures:

Measures

National investigative measures

Search

Seizure (with a view to gathering evidence)

Surrender of documents

Surrender of business records

Obtaining information or evidence already in possession of the executing authority

Obtaining information contained in databases held by police or judicial authorities

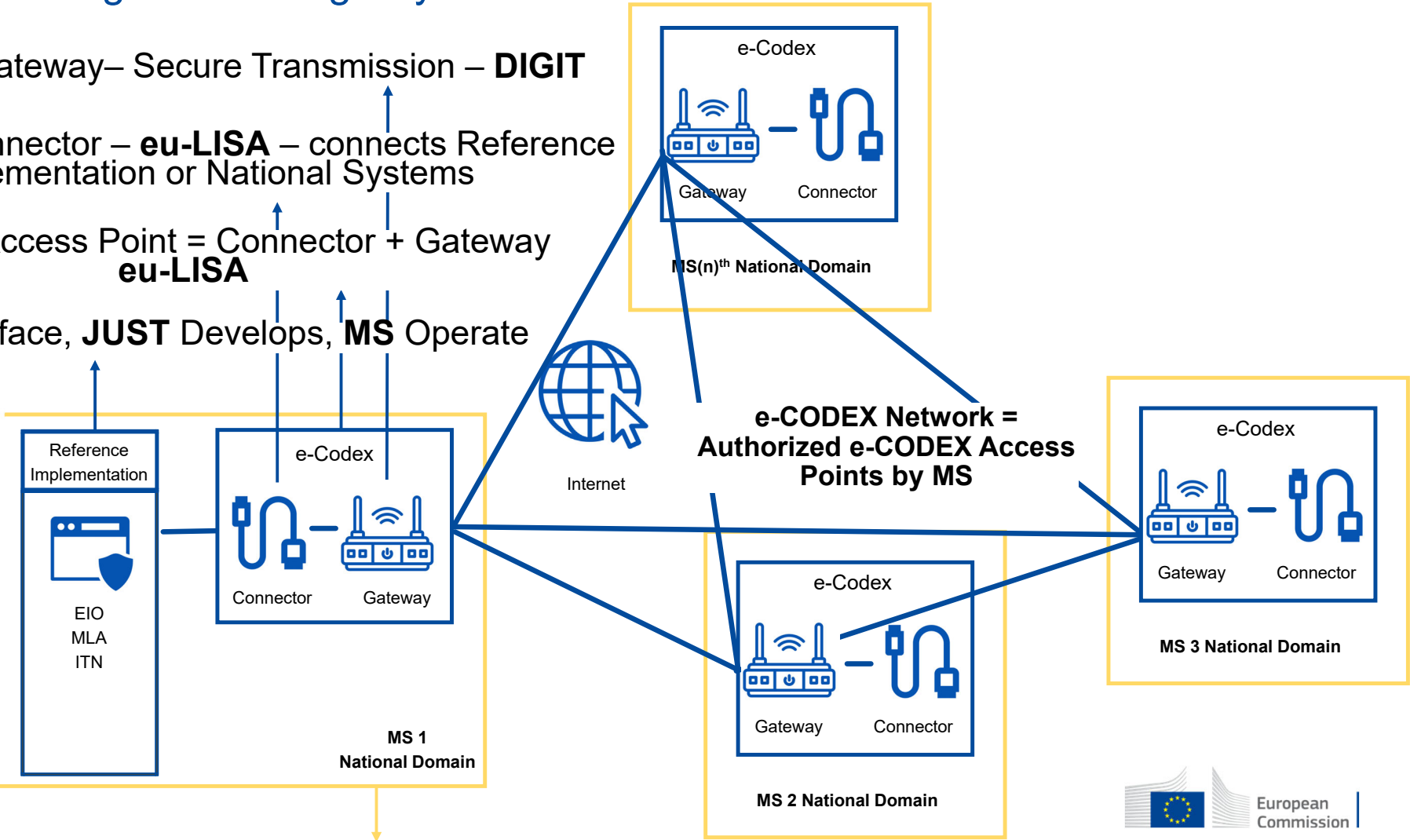

MS Full Responsibility Operations/Maintenance – Support to MS: eu-LISA

A Digital Exchange System

e-Delivery Gateway – Secure Transmission – **DIGIT**

e-CODEX Connector – **eu-LISA** – connects Reference Implementation or National Systems

e-CODEX Access Point = Connector + Gateway
eu-LISA

User interface, **JUST** Develops, **MS** Operate

The screenshot shows a web browser window with the URL `pl.demo.eeu.fsc.atos-services.net/drafts/case/2a9006b9-73e2-4746-a8a4-c40170de315b/eio/annex_a`. The interface includes a sidebar with navigation options like 'Dashboard', 'Issued requests', 'Received requests', and 'Drafts'. The main content area displays a form for 'Annex A' with sections for 'Request Data', 'SECTION A', 'SECTION B | Urgency', 'SECTION C', 'SECTION D', 'SECTION E', and 'SECTION F'. Each section contains specific data entry fields and checkboxes.

Reference Implementation

e-Codex

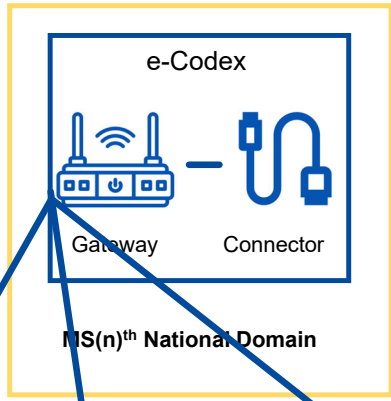

e-CODEX Network = Authorized e-CODEX Access Points by MS

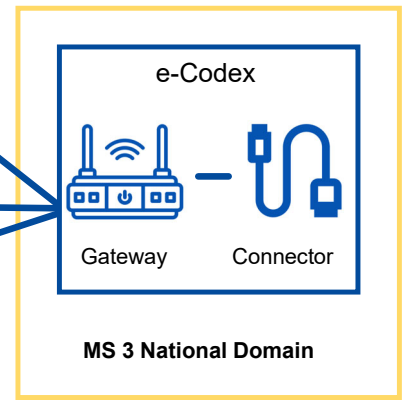
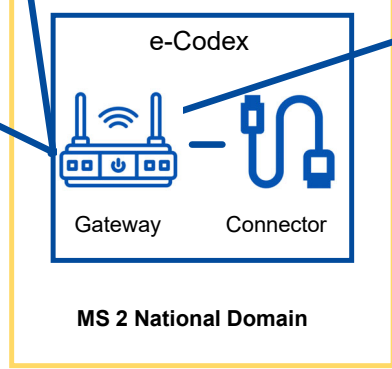

MS Full Responsibility Operations/Maintenance – Support to MS: eu-LISA



e-Evidence Digital Exchange System - eEDES Architecture and Interoperability

AT, BE, DE, ES, FR, HU, LU, LV, PT, PL, SI
(as of October 2023)

JUST responsible RI + e-CODEX work together

MS Full Responsibility Operations/Maintenance –
Support to MS: **eu-LISA + JUST**

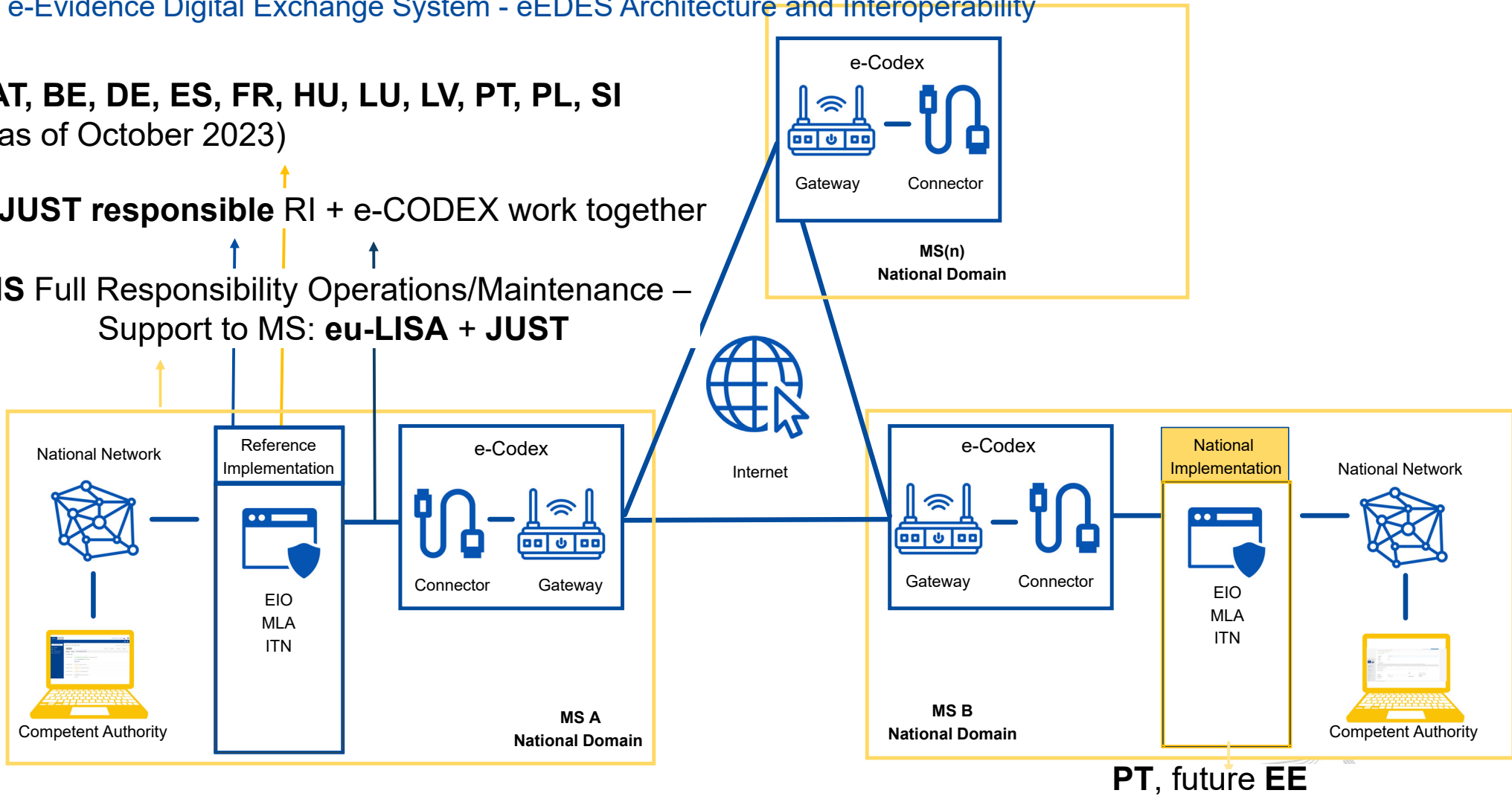

National CMS - MS Develops, Operates, Maintains

Roadmap for eEDES

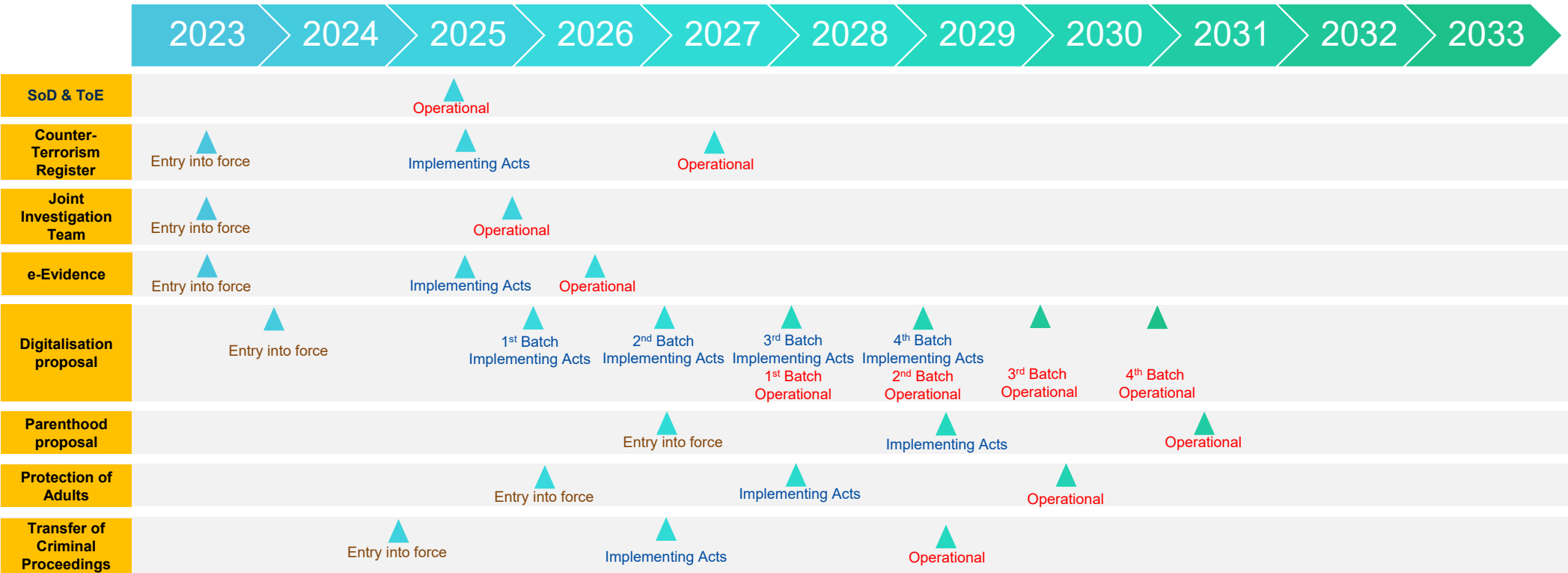

- 1st Batch**
1. Regulation (EC) No 1896/2006 of the European Parliament and of the Council of 12 December 2006 creating a European order for payment procedure. (EOP)
 2. Regulation (EC) No 861/2007 of the European Parliament and of the Council of 11 July 2007 establishing a European Small Claims Procedure. (SC)
 3. Council Framework Decision 2002/584/JHA of 13 June 2002 on the European arrest warrant and the surrender procedures between Member States. (EAW)
 4. Directive 2014/41/EU of the European Parliament and of the Council of 3 April 2014 regarding the European Investigation Order in criminal matters. (EIO)
 5. Regulation (EU) 2018/1805 of the European Parliament and of the Council of 14 November 2018 on the mutual recognition of freezing orders and confiscation orders. (FCO)

- 2nd Batch**
1. Council Directive 2003/8/EC of 27 January 2003 to improve access to justice in cross-border disputes by establishing minimum common rules relating to legal aid for such disputes. (Legal Aid)
 2. Regulation (EU) No 606/2013 of the European Parliament and of the Council of 12 June 2013 on mutual recognition of protection measures in civil matters (Protection measures-civil matters).
 3. Regulation (EU) No 655/2014 of the European Parliament and of the Council of 15 May 2014 establishing a European Account Preservation Order procedure to facilitate cross-border debt recovery in civil and commercial matters. (EAPO)
 4. Regulation (EU) 2015/848 of the European Parliament and of the Council of 20 May 2015 on insolvency proceedings. (Insolvency)
 5. Council Framework Decision 2008/909/JHA of 27 November 2008 on the application of the principle of mutual recognition to judgments in criminal matters imposing custodial sentences or measures involving deprivation of liberty for the purpose of their enforcement in the European Union. (Custodial sentences)
 6. Directive 2011/99/EU of the European Parliament and of the Council of 13 December 2011 on the European protection order. (Protection order)

- 3rd Batch**
1. Regulation (EU) No 650/2012 of the European Parliament and of the Council of 4 July 2012 on jurisdiction, applicable law, recognition and enforcement of decisions and acceptance and enforcement of authentic instruments in matters of succession and on the creation of a European Certificate of Succession. (Successions)
 2. Council Regulation (EU) 2016/1103 of 24 June 2016 implementing enhanced cooperation in the area of jurisdiction, applicable law and the recognition and enforcement of decisions in matters of matrimonial property regimes. (Matrimonial property regimes)
 3. Council Regulation (EU) 2016/1104 of 24 June 2016 implementing enhanced cooperation in the area of jurisdiction, applicable law and the recognition and enforcement of decisions in matters of the property consequences of registered partnerships. (Registered partnerships)
 4. Council Framework Decision 2003/577/JHA of 22 July 2003 on the execution in the European Union of orders freezing property or evidence. (Freezing order)
 5. Council Framework Decision 2005/214/JHA of 24 February 2005 on the application of the principle of mutual recognition to financial penalties. (Financial penalties)
 6. Council Framework Decision 2006/783/JHA of 6 October 2006 on the application of the principle of mutual recognition to confiscation orders. (Confiscation orders)
 7. Council Framework Decision 2009/948/JHA of 30 November 2009 on prevention and settlement of conflicts of exercise of jurisdiction in criminal proceedings. (Jurisdiction in criminal proceedings)

- 4th Batch**
1. Regulation (EC) No 805/2004 of the European Parliament and of the Council of 21 April 2004 creating a European Enforcement Order for uncontested claims. (Enforcement orders for uncontested claims EEO)
 2. Council Regulation (EC) No 4/2009 of 18 December 2008 on jurisdiction, applicable law, recognition and enforcement of decisions and cooperation in matters relating to maintenance obligations. (Maintenance obligations)
 3. Regulation (EU) No 1215/2012 of the European Parliament and of the Council of 12 December 2012 on jurisdiction and the recognition and enforcement of judgments in civil and commercial matters (recast). (Brussels Ia)
 4. Council Regulation (EU) 2019/1111 of 25 June 2019 on jurisdiction, the recognition and enforcement of decisions in matrimonial matters and the matters of parental responsibility, and on international child abduction. (Brussels Ila)
 5. Council Framework Decision 2008/947/JHA of 27 November 2008 on the application of the principle of mutual recognition to judgments and probation decisions with a view to the supervision of probation measures and alternative sanctions. (Alternative sanctions)
 6. Council Framework Decision 2009/829/JHA of 23 October 2009 on the application, between Member States of the European Union, of the principle of mutual recognition to decisions on supervision measures as an alternative to provisional detention. (Supervision measures)

Thank you



© European Union 2020

Unless otherwise noted the reuse of this presentation is authorised under the [CC BY 4.0](https://creativecommons.org/licenses/by/4.0/) license. For any use or reproduction of elements that are not owned by the EU, permission may need to be sought directly from the respective right holders.

Slide xx: [element concerned](#), source: [e.g. Fotolia.com](#); Slide xx: [element concerned](#), source: [e.g. iStock.com](#)

