



eInvoicing Workshop

29th August, Zagreb, Croatia

Connecting Europe Facility

DIGIT
Directorate-General
for Informatics

DG Connect
Directorate-General for Communications
Networks, Content and Technology

Christian Vindinge Rasmussen

Martin Forsberg

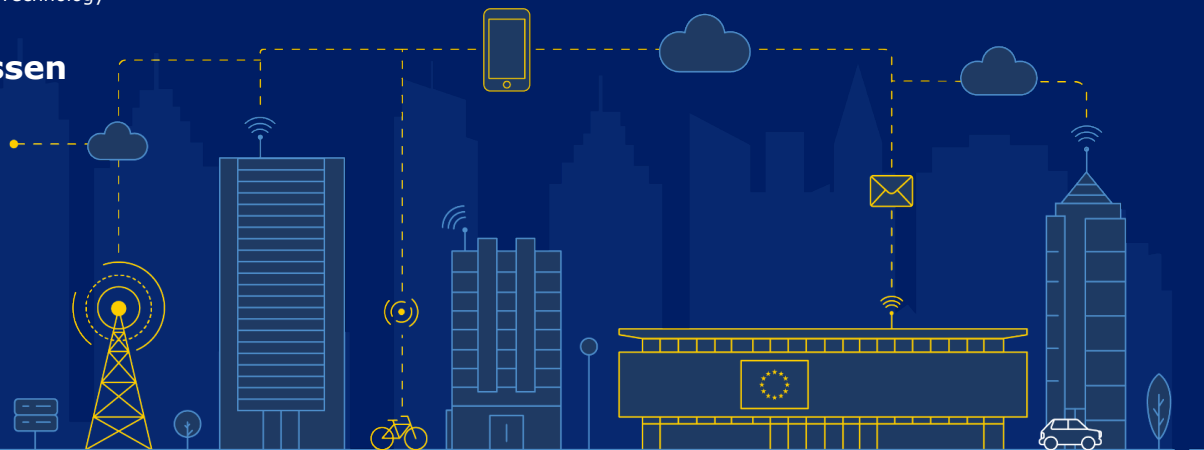

Today's speakers

Christian Rasmussen

Christian is an experienced eProcurement Expert specialized in the execution of large scale ICT projects with past experience from the Nordic region. Christian has been involved in the past EU-funded large scale pilots PEPPOL.eu and eSENS.eu as Work packager leader with focus on new eProcurement and eDelivery development. Christian works as a business development manager for e-Boks, Denmark.

Martin Forsberg

Martin Forsberg works as a subject matter expert in the area of electronic business, customs and financial processes. Martin was involved in the PEPPOL and eSENS Large Scale Pilots. He is active in standardization committees such as CEN TC434 and OASIS UBL. Martin works as a consultant for ECRU, Sweden across EU.

Mentimeter

www.menti.com

Enter #69 50 89



What is CEF?

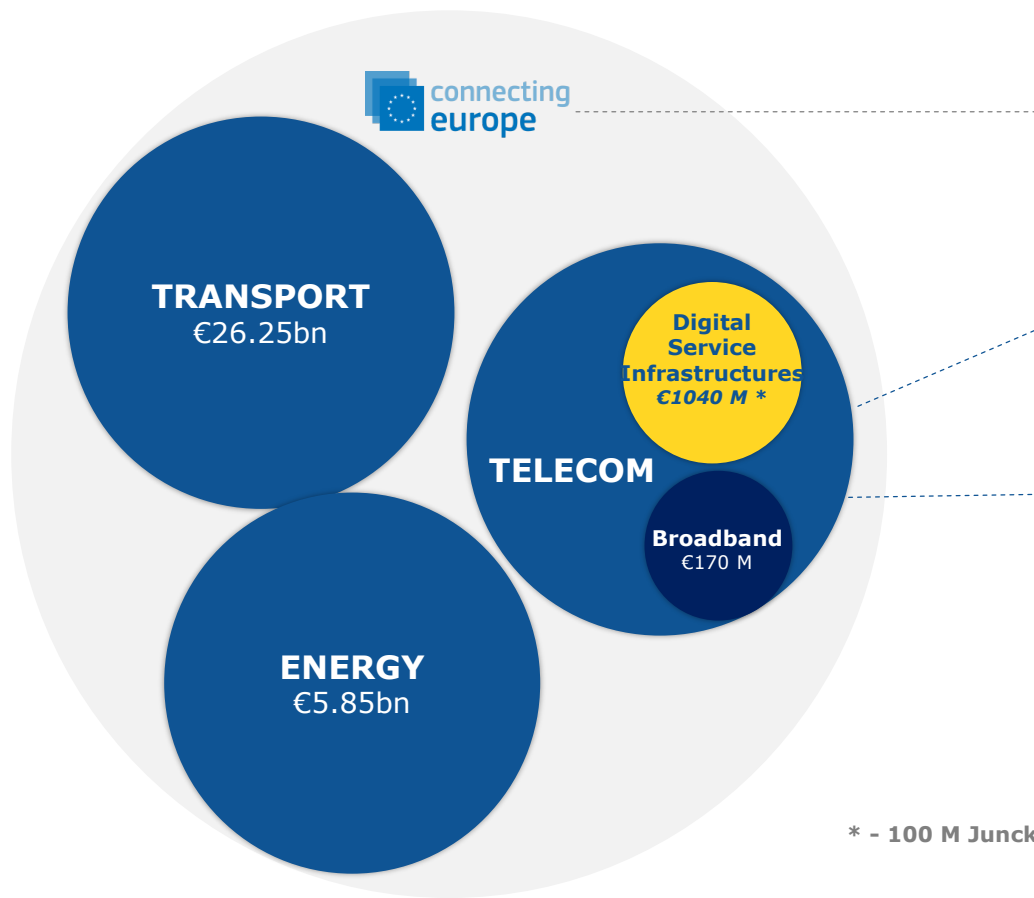

HOW IS IT REGULATED?

CEF Regulation

The Connecting Europe Facility (CEF) is a regulation that defines how the Commission can finance support for the establishment of trans-European networks to reinforce an interconnected Europe.

CEF Telecom Guidelines

The CEF Telecom guidelines cover the specific objectives and priorities as well as eligibility criteria for funding of broadband networks and Digital Service Infrastructures (DSIs).

CEF Work Programmes

Translates the CEF Telecom Guidelines in general objectives and actions planned on a yearly basis.

CEF Funding

From 2014-2020 1.040M Euro will be re-invested into adoption of the core building blocks in the DSIs.

Budget indications from 2020-2024 gives additional 1.600M Euro for further funding of implementation

* - 100 M Juncker Package

CEF Building Blocks

The **building blocks of the Connecting Europe Facility** promote the adoption of the same **open standards and technical specifications**, by the **different sectors** of the Union, for the most basic & common functionalities of any sectorial project/platform.

These core commonalities will enable interoperability across borders and sectors.



What is an implementation workshop?

- Build knowledge on the European standard
- Share best practices
- Strong cross-border perspective
- Help with roadmap on mass adoption
- Give practical input to implementation projects
- Give ideas on how to proceed and prioritize
- Learn about CEF services



A short retrospect

A short retrospect

Workshops so far...

- Finland
- Cyprus
- Poland
- Estonia
- Greece
- Sweden
- Austria
- Denmark
- Malta
- Ireland
- Lithuania
- Czech Republic
- Germany
- EESPA
- Romania
- Latvia



Common themes brought up by the participants

- What are other countries doing?
- What does it mean to comply with the European Standard?
- Intellectual Property Rights and Copyright
- Cross border exchange of eInvoices
- Policy – what is necessary for smooth adoption



Level of Readiness

- Growing sense of urgency
- Plans are getting more and more concrete
- Still focus on technical aspects
- Lack of appreciation of the change process
- Focus on compliance rather than potential gains



Look ahead and reap the benefits

Focus for 2019, 2020

- Take advantage of the investments made
- Strategies for supplier onboarding
- Digitalization of the full procurement process
- ***Beyond compliance - bring e-invoicing to the next level***

eInvoicing from a user perspective



Introduction from a European Point of View

Martin Forsberg
DIGIT

Background

- Problems with **many standards**
- **Lack of normative contextualised standards** (only workshop agreements)
- **Different approaches and ambitions** in Member States to implementing eInvoicing and eProcurement
- The Directive on electronic invoicing in public procurement ([Directive 2014/55/EU](#)) was developed, setting a **minimum requirement** for the public sector
- The Directive can in the transposition add further requirements

From the Directive

The benefits of electronic invoicing are maximised when the generation, sending, transmission, reception and processing of an invoice can be fully automated.

...

A mere image file should not be considered to be an electronic invoice for the purpose of this Directive.

Requirements for the contracting authorities/entities

From article 7

Receipt and processing of electronic invoices

*Member States shall ensure that contracting authorities and contracting entities **receive and process electronic invoices** which comply with the **European standard on electronic invoicing** whose reference has been published pursuant to Article 3(2) and with **any of the syntaxes on the list** published pursuant to Article 3(2).*

a list with a limited number of syntaxes which comply with the European standard on electronic invoicing

Semantic data model of the core elements of an electronic invoice

Definitions

(1) **'electronic invoice'** means an invoice that has been issued, transmitted and received in a structured electronic format which allows for its automatic and electronic processing;

(2) **'core elements of an electronic invoice'** means a set of essential information components which an electronic invoice must contain in order to enable cross-border interoperability, including the necessary information to ensure legal compliance;

(3) **'semantic data model'** means a structured and logically interrelated set of terms and their meanings that specify the core elements of an electronic invoice;

(4) **'syntax'** means the machine readable language or dialect used to represent the data elements contained in an electronic invoice;

(5) **'syntax bindings'** means guidelines on how a semantic data model for an electronic invoice could be represented in the various syntaxes;

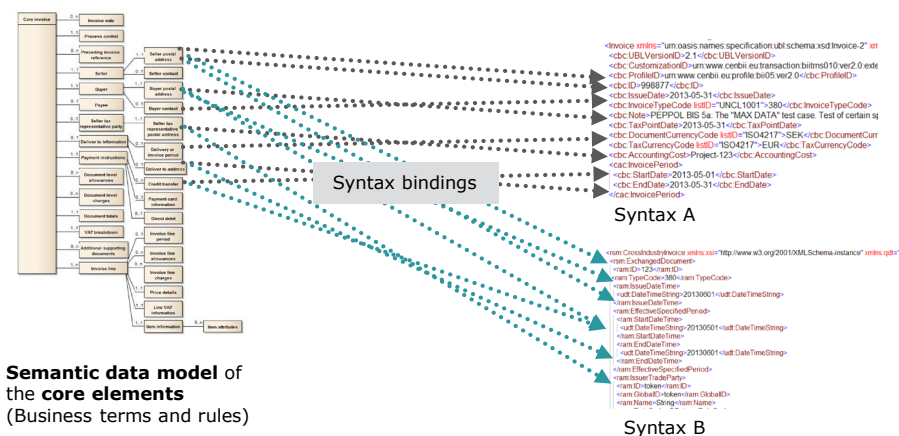
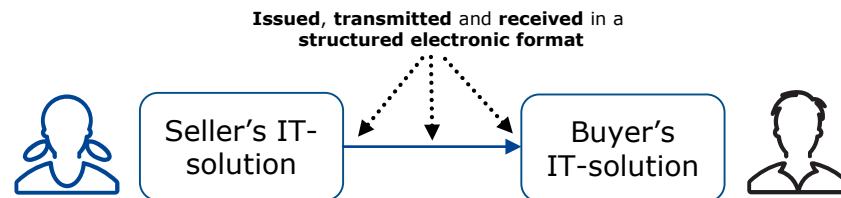

Semantic data model of the core elements
(Business terms and rules)

Key dates

16 April 2014

Directive 2014/55/EU

17 October 2017

Publication of the reference to the European Standard on eInvoicing in the Official Journal

18 April 2019

Deadline for Member States to transpose into national law

18 April 2020

Extended deadline (upon request) for contracting authorities and entities which are not central government authorities

So eInvoicing, in the context of the Directive, is

- Formatted in a structured way so that it can be processed efficiently
- Issued, transmitted and received electronically

This rules out:

- Paper invoices which are scanned by the receiver but managed in an electronic workflow system
- PDF-invoices created by the issuer and sent to the receiver

Implementation of the Directive – requirements on public entities and suppliers

1. As is – no additional restrictions
2. As 1 but with policy that requirement for eInvoice must be part of contracts/call for tenders
3. Requirement for suppliers to also send

Level of readiness

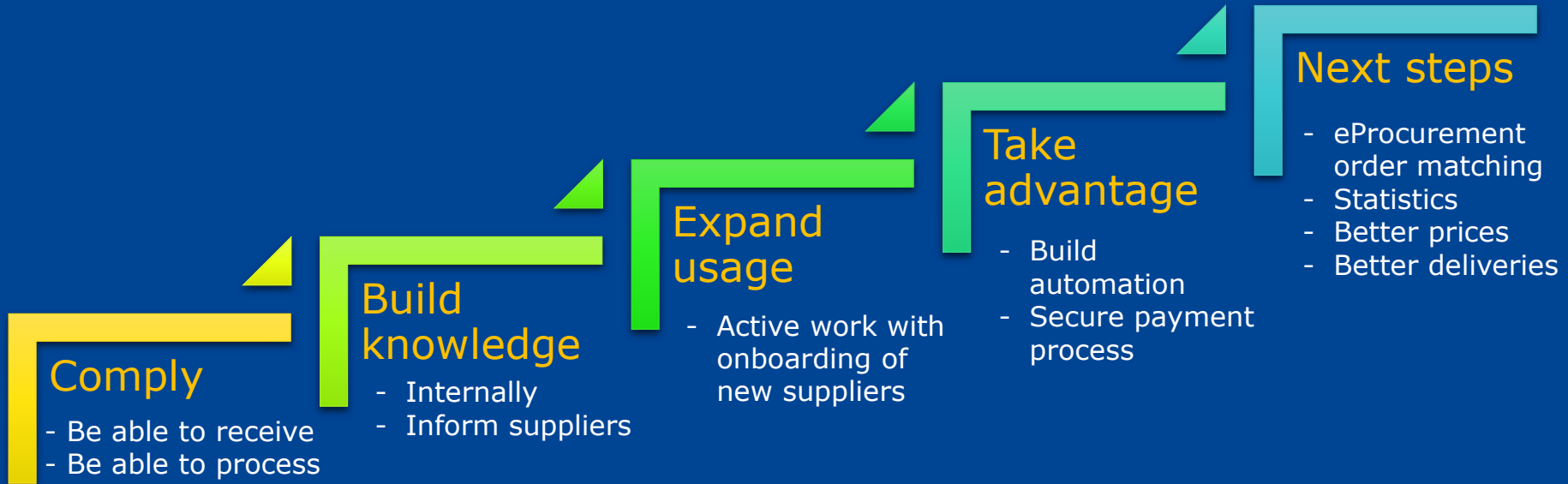



The European Norm and its content

Martin Forsberg

DIGIT

Initiation of the standardisation

From article 3

*The Commission shall request that the relevant **European standardisation organisation** draft a European standard for the semantic data model of the core elements of an electronic invoice (the 'European standard on electronic invoicing').*

...

The Commission shall request that the relevant European standardisation organisation provide a list with a limited number of syntaxes which comply with the European standard on electronic invoicing, the appropriate syntax bindings and guidelines on transmission interoperability, in order to facilitate the use of such standard.

CEN/TC 434 was established

- CEN - European Committee for Standardisation
- The work started in a project committee (PC434) but was later changed into a technical committee (TC434)
- TC434 has over 100 committee members from 31 countries
- Participation in the work must go through the national standardisation committees.
- The committee is about to finalize all deliverables defined in the standardisation request

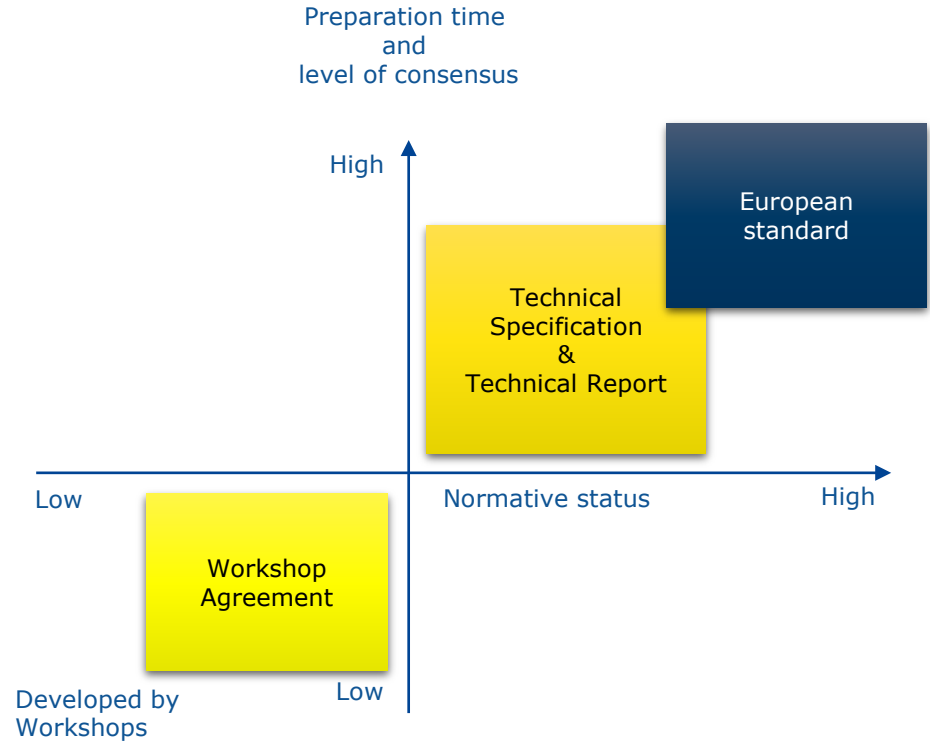

Current status

Number	Title	Status
EN 16931-1	Semantic data model of the core elements of an electronic invoice	Approved!
CEN/TS 16931-2	List of syntaxes that comply with EN 16931-1	Approved!
CEN/TS 16931-3-1	Methodology for syntax bindings of the core elements of an electronic invoice	Approved!
CEN/TS 16931-3-2	Syntax binding for ISO/IEC 19845 (UBL2.1) invoice and credit note	Approved!
CEN/TS 16931-3-3	Syntax binding for UN/CEFACT XML Cross Industry Invoice D16B	Approved!
CEN/TS 16931-3-4	Syntax binding for UN/EDIFACT D16B	Approved!
CEN/TR 16931-4	Guidelines on interoperability of electronic invoices at the transmission level	Approved!
CEN/TR 16931-5	Guidelines on the use of sector or country extensions in conjunction with EN 16931-1, methodology to be applied in the real environment	Approved!
CEN/TR 16931-6	Result of the test of EN 16931-1 with respect to its practical application for an end user	Approved!

Introduction to key concepts of the standard

EUROPEAN STANDARD

EN 16931-1

NORME EUROPÉENNE

EUROPÄISCHE NORM

June 2017

ICS 35.240.20; 35.240.63

English Version

Electronic invoicing - Part 1: Semantic data model of the
core elements of an electronic invoice

Facturation électronique - Partie 1: Modèle sémantique
de données des éléments essentiels d'une facture
électronique

Elektronische Rechnungsstellung - Teil 1:
Semantisches Datenmodell der Kernelemente einer
elektronischen Rechnung

This European Standard was approved by CEN on 17 April 2017.

CEN members are bound to comply with the CEN/CENELEC Internal Regulations which stipulate the conditions for giving this European Standard the status of a national standard without any alteration. Up-to-date lists and bibliographical references concerning such national standards may be obtained on application to the CEN-CENELEC Management Centre or to any CEN member.

This European Standard exists in three official versions (English, French, German). A version in any other language made by translation under the responsibility of a CEN member into its own language and notified to the CEN-CENELEC Management Centre has the same status as the official versions.

CEN members are the national standards bodies of Austria, Belgium, Bulgaria, Croatia, Cyprus, Czech Republic, Denmark, Estonia, Finland, Former Yugoslav Republic of Macedonia, France, Germany, Greece, Hungary, Iceland, Ireland, Italy, Latvia, Lithuania, Luxembourg, Malta, Netherlands, Norway, Poland, Portugal, Romania, Serbia, Slovakia, Slovenia, Spain, Sweden, Switzerland, Turkey and United Kingdom.



EUROPEAN COMMITTEE FOR STANDARDIZATION
COMITÉ EUROPÉEN DE NORMALISATION
EUROPÄISCHES KOMITEE FÜR NORMUNG

CEN-CENELEC Management Centre: Avenue Marnix 17, B-1000 Brussels

© 2017 CEN All rights of exploitation in any form and by any means reserved
worldwide for CEN national Members.

Ref. No. EN 16931-1:2017 E

Section 1-3 - Scope, references, terms & definitions

Section 4 – The concept of a core invoice

Section 5 – Business process to support

Section 6 – The semantic model, rules and data types

Section 7 – Core Invoice Usage Specification (and
compliance)

Annex A – Examples (Informative)

Annex B – Assessment of the EN towards the
Standardization request (Informative)

Annex C – How does the EN meet legal
requirements (Informative)

Annex D – BPMN symbols (informative)

Areas covered by the standard

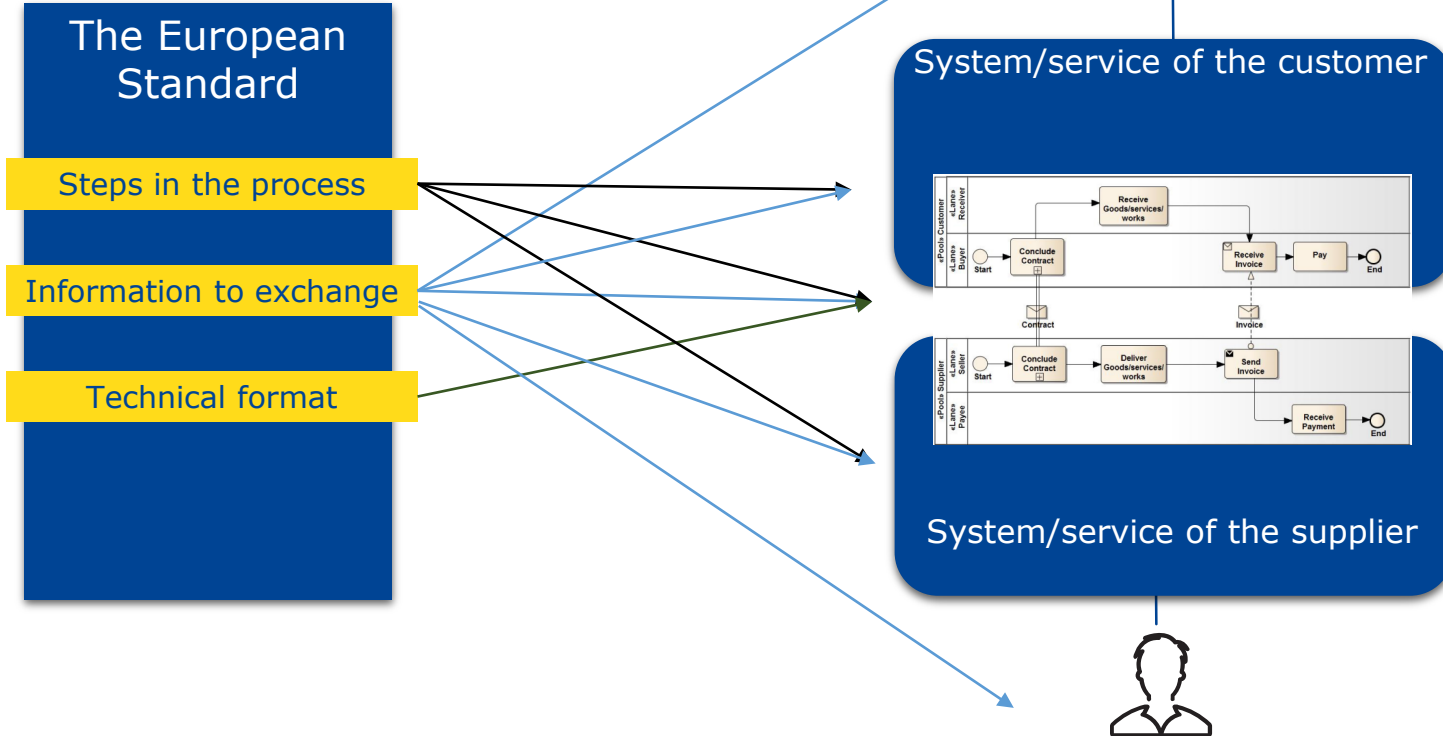

Reasons for a core invoice

The European standard recognises the following reasons:

- Business environment is diverse – also the need for information exchange
- Invoices from different situations may potentially contain many information elements – a complete model becomes very large and complex
- Even if it would technically be possible to have a large model, it would be challenging and costly
- When different countries/industries use subset of large standards, interoperability is hampered and silo-implementations are created

Common understanding

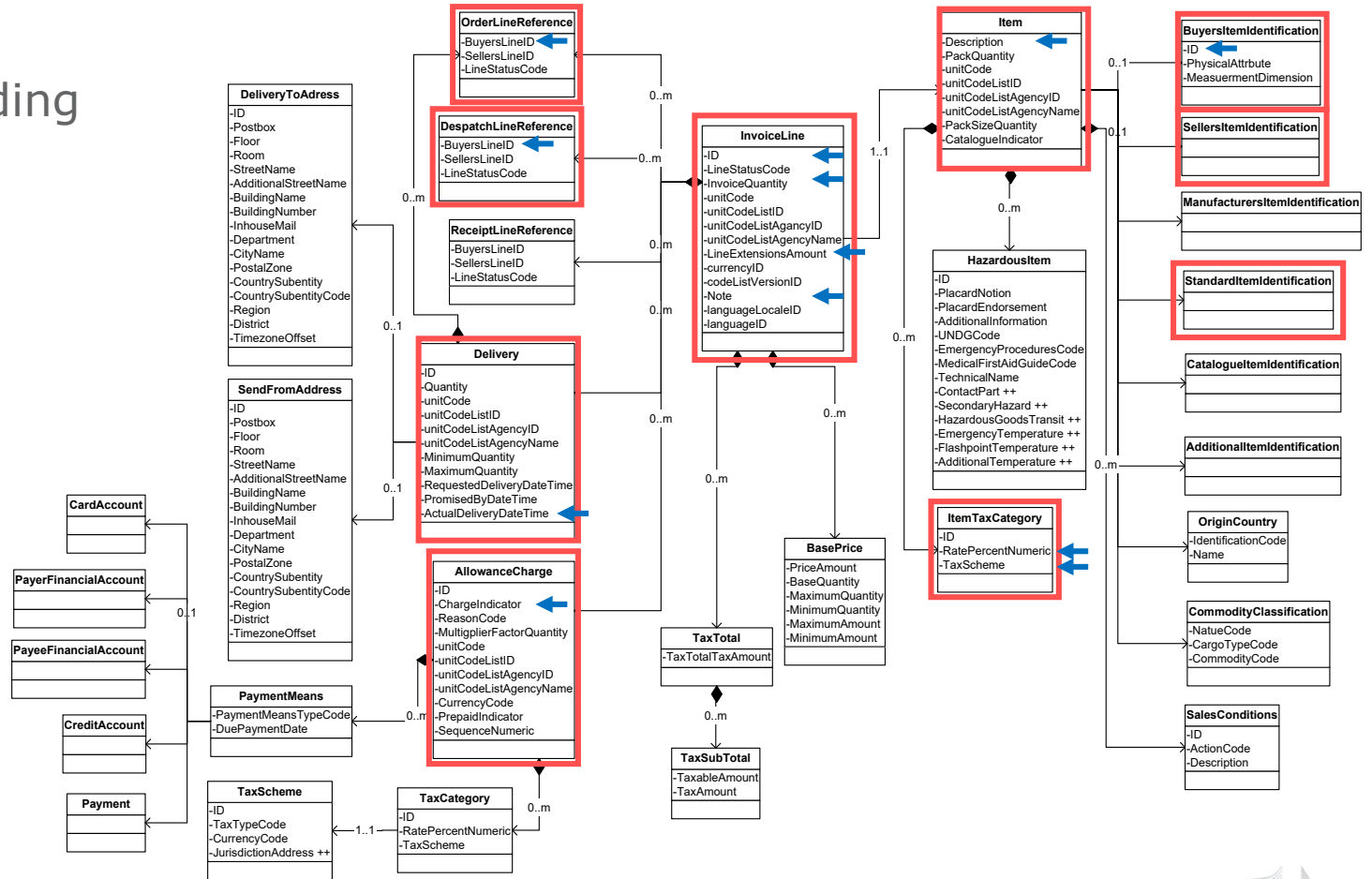

Requirement driven approach on defining the model

- Each business term in the model comes from one or more documented (and numbered) requirement
- The requirements give a good understanding of the background

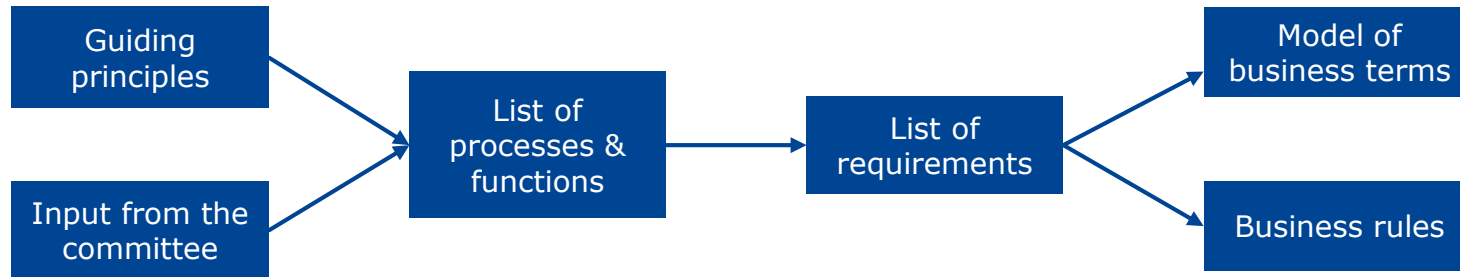

The concept of a core invoice – How?

The norm identifies a few **guiding principles**:

- It should be easier to use than paper invoicing
- Standardised information elements makes processing more efficient (than paper invoices)
- It should be possible to use without prior consultation or bilateral agreements
- It should contain information to enable efficient and automatic processing
- Software should be able to present all information, and automatically process structured data
- Structured data should result in optimised business processes
- The core invoice model should not make assumptions on the method of creation, delivery or processing
- The core invoice model should not make assumptions on the syntax or transmission technology

Access to the specifications

EC is sponsoring access – to the EN and the list of syntaxes. These specifications are available for free download

The other specifications must still be purchased

cen European Committee for Standardization

CEN COMMUNITY TECHNICAL BODIES STANDARDS EVOLUTION AND FORECAST SEARCH STANDARDS

Technical Bodies > CEN/TC 434

CEN/TC 434 - Electronic Invoicing

General Structure Work programme Published Standards

EN FR DE

CEN/TC 434 Published Standards

Reference, Title	Publication date	Sales Points
CEN/TR 16931-4:2017 (WI=00434004) Electronic invoicing - Part 4: Guidelines on interoperability of electronic invoices at the transmission level	2017-07-05	
CEN/TR 16931-5:2017 (WI=00434005) Electronic invoicing - Part 5: Guidelines on the use of sector or country extensions in conjunction with EN 16931-1, methodology to be applied in the real environment	2017-07-05	
CEN/TR 16931-6:2017 (WI=00434006) Electronic invoicing - Part 6: Result of the test of EN 16931-1 with respect to its practical application for an end user	2017-10-18	
CEN/TS 16931-2:2017 (WI=00434002) Electronic invoicing - Part 2: List of syntaxes that comply with EN 16931-1	2017-06-28	
CEN/TS 16931-3-1:2017 (WI=00434007) Electronic invoicing - Part 3-1: Methodology for syntax bindings of the core elements of an electronic invoice	2017-07-05	
CEN/TS 16931-3-2:2017 (WI=00434008) Electronic invoicing - Part 3-2: Syntax binding for ISO/IEC 19845 (UBL 2.1) invoice and credit note	2017-10-18	
CEN/TS 16931-3-2:2017/AC:2018 (WI=00434C01) Electronic invoicing - Part 3-2: Syntax binding for ISO/IEC 19845 (UBL 2.1) invoice and credit note	2018-07-18	
CEN/TS 16931-3-3:2017 (WI=00434009) Electronic invoicing - Part 3-3: Syntax binding for UN/CEFACT XML Industry Invoice D16B	2017-10-18	
CEN/TS 16931-3-4:2017 (WI=00434010) Electronic invoicing - Part 3-4: Syntax binding for UN/EDIFACT INVOIC D16B	2017-10-18	
EN 16931-1:2017 (WI=00434001) Electronic invoicing - Part 1: Semantic data model of the core elements of an electronic invoice	2017-06-28	



Syntaxes which comply with the European standard on eInvoicing

Martin Forsberg

DIGIT

Many syntaxes – a problem?

- There are a large number of syntaxes in use
- Many communities are already using e-invoicing since a long time
- Use of many syntaxes result in interoperability problems

(9)

In order to further simplify the use of electronic invoicing and to reduce costs, one of the long-term objectives should be to **limit the number of syntaxes used**, preferably by concentrating on those most commonly used.

Article 3

Establishment of a European standard

...

The Commission shall request that the relevant European standardisation organisation **provide a list with a limited number of syntaxes** which comply with the European standard on electronic invoicing, the appropriate syntax bindings and guidelines on transmission interoperability, in order to facilitate the use of such standard.

Article 7

Receipt and processing of electronic invoices

Member States shall ensure that contracting authorities and contracting entities receive and process electronic invoices which comply with the European standard on electronic invoicing whose reference has been published pursuant to Article 3(2) and with **any of the syntaxes on the list** published pursuant to Article 3(2).

The standardization request from EC defined a number of criteria

Req ID Requirement of sub-requirement

1	Comply with the core invoice semantic data model specified in the EN
2	Be international, open and free to use
3	Have a governance and sustainability model
3.1	There is an established organisation maintaining the syntax (format)
3.2	There is a maintenance process that is: <ul style="list-style-type: none">- documented with defined participation and voting rules;- governed;- open to participation for stakeholders.
3.3	There is a funding model allowing further development and maintenance.
3.4	Support can be provided (consulting, educating, training) to solution providers (implementers) or users (companies, PAs etc.).
4	Be part of a coherent set of standards and technical specifications to support the broader e-procurement process or the broader e-invoicing supply chain
5	Be widely used in the EU or worldwide
6	Be used in production environments (and not just test) by both the public and the private sector
7	Reflect well-accepted technology and aim to incorporate the latest technological developments considered to be state of the art
8	Have guidelines, code lists, validating tools freely available to ease implementation by ICT vendors and suppliers
9	Have a set of official, freely available syntax-dependent artefacts for validation (the XML Schema or Schematron) to support tool independent validation
10	Have an official updating and versioning strategy that takes due account of backward compatibility, as well as appropriate guidelines for customisation that explain how to extend and restrict the syntax

Specifications from CEN/TC434

Reference	WG	Title
EN 16931-1	WG1	Electronic invoicing - Part 1: Semantic data model of the core elements of an electronic invoice
TS 16931-2	WG2	Electronic invoicing - Part 2: List of syntaxes that comply with EN 16931-1
TS 16931-3-1	WG3	Electronic invoicing - Part 3-1: Methodology for syntax bindings of the core elements of an electronic invoice
TS 16931-3-2	WG3	Electronic invoicing - Part 3-2: Syntax binding for ISO/IEC 19845 (UBL 2.1) invoice and credit note
TS 16931-3-3	WG3	Electronic invoicing - Part 3-3: Syntax binding for UN/CEFACT XML Cross Industry Invoice D16B
TS 16931-3-4	WG3	Electronic invoicing - Part 3-4: Syntax binding for UN/EDIFACT INVOIC D16B
TS 16931-3-5	WG3	Electronic invoicing - Part 3-5: Syntax binding for the Financial Invoice based on ISO 20022
TR 16931-4	WG4	Electronic invoicing - Part 4: Guidelines on interoperability of electronic invoices at the transmission guideline
TR 16931-5	WG5	Electronic invoicing - Part 5: Guidelines on the use of sector or country extensions in conjunction with EN 16931-1, methodology to be applied in the real environment
TR 16931-6	WG6	Electronic invoicing - Part 6: result of the test of EN 16931-1 with respect to its practical application for an end user

Specifications from CEN/TC434

Reference	WG	Title
EN 16931-1	WG1	Electronic invoicing - Part 1: Semantic data model of the core elements of an electronic invoice
TS 16931-2	WG2	Electronic invoicing - Part 2: List of syntaxes that comply with EN 16931-1
TS 16931-3-1	WG3	Electronic invoicing - Part 3-1: Methodology for syntax bindings of the core elements of an electronic invoice
TS 16931-3-2	WG3	Electronic invoicing - Part 3-2: Syntax binding for ISO/IEC 19845 (UBL 2.1) invoice and credit note
TS 16931-3-3	WG3	Electronic invoicing - Part 3-3: Syntax binding for UN/CEFACT XML Cross Industry Invoice D16B
TS 16931-3-4	WG3	Electronic invoicing - Part 3-4: Syntax binding for UN/EDIFACT INVOIC D16B
TS 16931-3-5	WG3	Electronic invoicing - Part 3-5: Syntax binding for the Financial Invoice based on ISO 20022
TR 16931-4	WG4	Electronic invoicing - Part 4: Guidelines on interoperability of electronic invoices at the transmission guideline
TR 16931-5	WG5	Electronic invoicing - Part 5: Guidelines on the use of sector or country extensions in conjunction with EN 16931-1, methodology to be applied in the real environment
TR 16931-6	WG6	Electronic invoicing - Part 6: result of the test of EN 16931-1 with respect to its practical application for an end user

Specifications from CEN/TC434

Reference	WG	Title
EN 16931-1	WG1	Electronic invoicing - Part 1: Semantic data model of the core elements of an electronic invoice
TS 16931-2	WG2	Electronic invoicing - Part 2: List of syntaxes that comply with EN 16931-1
TS 16931-3-1	WG3	Electronic invoicing - Part 3-1: Methodology for syntax bindings of the core elements of an electronic invoice
TS 16931-3-2	WG3	Electronic invoicing - Part 3-2: Syntax binding for ISO/IEC 19845 (UBL 2.1) invoice and credit note
TS 16931-3-3	WG3	Electronic invoicing - Part 3-3: Syntax binding for UN/CEFACT XML Cross Industry Invoice D16B
TS 16931-3-4	WG3	Electronic invoicing - Part 3-4: Syntax binding for UN/EDIFACT INVOIC D16B
TS 16931-3-5	WG3	Electronic invoicing - Part 3-5: Syntax binding for the Financial Invoice based on ISO 20022
TR 16931-4	WG4	Electronic invoicing - Part 4: Guidelines on interoperability of electronic invoices at the transmission guideline
TR 16931-5	WG5	Electronic invoicing - Part 5: Guidelines on the use of sector or country extensions in conjunction with EN 16931-1, methodology to be applied in the real environment
TR 16931-6	WG6	Electronic invoicing - Part 6: result of the test of EN 16931-1 with respect to its practical application for an end user



A closer look at UBL and CII

For both UBL 2.1 and UN/CEFACT Cross Industry Invoice

- Overview of the Specifications, XML-schemas and other resources
- Use of namespaces, versioning and document types
- Handling of code lists
- Typical message design and key syntactical features



UBL Version 2.1 – ISO/IEC 19845:2015

Overview of the standard



- UBL stands for Universal Business Language
- OASIS UBL 2.1 is developed and maintained by the UBL Technical Committee within OASIS
- UBL is an ISO-standard (ISO/IEC 19845-2015)

- UBL was developed with starting point in the CBL/xCBL format
- Sweden and Denmark early adopters around 2003-2004

UBL 1.0



- Published 2004
- Order To Invoice (8 Documents)
- >600 elements in common library

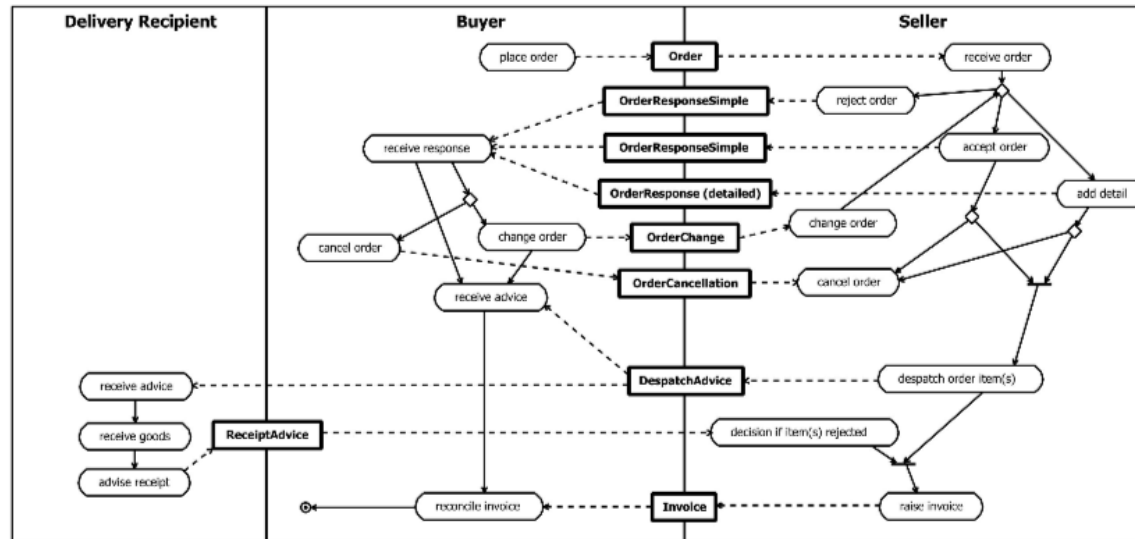

UBL 2.0

- 31 business documents
- >1900 elements in common library
- Input from European projects
- Published 2006

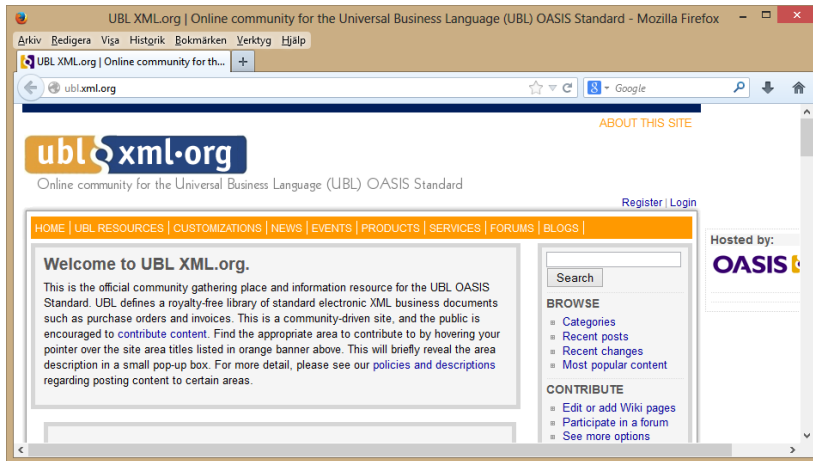

Sourcing (product and price synchronization)

- Catalogue Request, Catalogue, Catalogue Item Specification Update,
- Catalogue Pricing Update, Catalogue Deletion, Request For Quotation, Quotation

Fulfilment (shipping)

- Forwarding Instructions, Packing List, Bill Of Lading, Waybill, Certificate Of Origin
- Transportation Status

Billing

- Credit Note, Debit Note, Self Billed Invoice, Self Billed Credit Note, Freight
- Invoice, Reminder

Payment

- Remittance Advice, Statement

Additional document types

- Application Response, Attached Document

UBL 2.1

- 62 business documents
- Library of >2300 elements
- Built based on input from projects like CEN/BII, PEPPOL, ePRIOR and freight management projects
- Backward compatible with UBL 2.0.
 - Any XML-instance produced based on UBL 2.0 will validate using UBL 2.1

Additional guidelines

- Customization Methodology
- Generic Code list support
- Digital signature extension (XAdES)

Sourcing (product and price synchronization)

- Catalogue Request, Catalogue, Catalogue Item Specification Update,
- Catalogue Pricing Update, Catalogue Deletion, Request For Quotation, Quotation

Fulfilment (shipping)

- Forwarding Instructions, Packing List, Bill Of Lading, Waybill, Certificate Of Origin
- Transportation Status ,Fulfilment Cancellation

Billing

- Invoice, Credit Note, Debit Note, Self Billed Invoice, Self Billed Credit Note, Freight Invoice, Reminder

Payment

- Remittance Advice, Statement

Tendering

- Awarded Notification, Call for Tenders, Contract Award Notice, Contract Notice
- Guarantee Certificate, Prior Information Notice, Tender, Tender Receipt
- Tenderer Qualification, Tenderer Qualification Response, Unawarded Notification

VICS Collaborative Planning, Forecasting, and Replenishment

- Exception Criteria, Exception Notification, Forecast, Forecast Revision
- Item Information Request, Product Activity

Vendor Managed Inventory

- Instruction for Returns, Inventory Report, Retail Event, Stock Availability Report
- Trade Item Location Profile

Intermodal Freight Management

- Goods Item Itinerary, Packing List, Transport Execution Plan, Transport Execution Plan Request
- Transport Progress Status, Transport Progress Status Request, Transport Service Description
- Transport Service Description Request, Transportation Status, Transportation Status Request

Utility Billing

- Utility Statement

Additional Documents

- Application Response, Attached Document
- Document Status, Document Status Request

Localization

- UBL TC has a number of localization subcommittees
- Translated business term names and definitions
- UBL 1 is translated into
 - Chinese (traditional and simplified)
 - Japanese
 - Korean
 - Spanish
 - Italian
- UBL 2 is translated into
 - Italian
 - Spanish
 - German
 - Slovak
- And partially to
 - Danish
 - Turkish
 - Hungarian
 - Lithuanian

	A	B	C	D	E
	UBL Name	Description in Japanese	BIE Dictionary Entry Name	Object Class	Qualifier
1	Order	注文情報	Order.Details	Order	Order
2	ID	注文情報の識別子	Order.Identifier	Order	Order
3	CopyIndicator	複製レベル(原本/複製)	Order.Copy.Indicator	Order	Order
4	GUID	グローバル識別子	Order.Globally Unique Identifier	Order	Order
5	IssueDate	作成日	Order.Issue.Date	Order	Order
6	Note	備考	Order.Note.Text	Order	Order
7	AcknowledgementResponseCode	応答コード	Order.Acknowledgement_Response.Code	Order	Order
8	TransactionCurrencyCode	注文情報の通貨単位(ISO)	Order.Transaction_Currency.Code	Order	Order
9	PricingCurrencyCode	価格情報の通貨単位(ISO)	Order.Pricing_Currency.Code	Order	Order
10	EarliestDate	有効開始日	Order.Earliest.Date	Order	Order

Use of namespaces, versioning and document types

- Each document type has its unique Namespace
 - **Invoice**: urn:oasis:names:specification:ubl:schema:xsd:Invoice-2
 - **CreditNote**: urn:oasis:names:specification:ubl:schema:xsd:CreditNote-2
- Only major version of UBL is “visible” in namespace
- Minor version number is stated in the message: `<cbc:UBLVersionID>2.1</cbc:UBLVersionID>`



UN/CEFACT Cross Industry Invoice D16B

Overview of the standard

- CII stands for Cross Industry Invoice
- CII is developed and maintained by UN/CEFACT
- UN/CEFACT serves as the focal point for trade facilitation recommendations and electronic business standards, covering both commercial and government business processes that can foster growth in international trade and related services.
- UN/CEFACT develops and maintains UN/EDIFACT, XML Schemas, Code lists and a number of UNECE Recommendations (such as Recommendation N°. 20 - Codes for Units of Measure)

Cross Industry messages

- Version 1 published 2009 (as part of D09A)
- In D09B, Cross Industry Order, Catalogue and DespatchAdvice were added
- New schemas are normally published 2 times a year
- Since 2016, UN/CEFACT publishes two branches of the Cross Industry Invoice XML Schemas
- One branch following the same method as before. Currently it contains 16 different Cross Industry (messages) XML schemas
- One branch called the Supply Chain Reference Data Model (SCRDM) which are process-driven schemas derived from the model. Currently it only contains the Cross Industry Invoice-message

XML Schemas

Issued	Document Title	Download
2017	XML Schemas version 17B	ZIP
	Validation Report	PDF
2017	XML Schemas version 17A	ZIP
	Validation Report	PDF
2016	XML Schemas 16B (SCRDM - CII)	ZIP
	XML Schemas version 16B	ZIP
	Validation Report	PDF
2016	Release notes	PDF
	XML Schemas update 16A.1 (SCRDM - CII)	ZIP
	XML Schemas version 16A	ZIP
	Validation Report	PDF
2015	Release notes	PDF
	XML Schemas version 15B	ZIP
	Validation Report	PDF
2015	Release notes	PDF
	XML Schemas version 15A	ZIP
	Validation Report	PDF
2015	Release notes	PDF
	XML Schemas version 14B	ZIP
	Validation report	PDF
2014	Release notes	PDF
	XML Schemas version 13B	ZIP
	Validation report	PDF
2013	XML Schemas version 13A	ZIP

Use of namespaces, versioning and document types

- Each document type has its unique Namespace (Invoice and CreditNote use the same schema)
 - **SCRDM branch CrossIndustryInvoice:**
urn:un:unece:uncefact:data:standard:CrossIndustryInvoice:100
 - **“Old” branch CrossIndustryInvoice:**
urn:un:unece:uncefact:data:standard:CrossIndustryInvoice:13
- The List of syntaxes that comply with EN 16931-1 has evaluated and includes the SCRDM-version



Syntax bindings

Syntax binding specifications

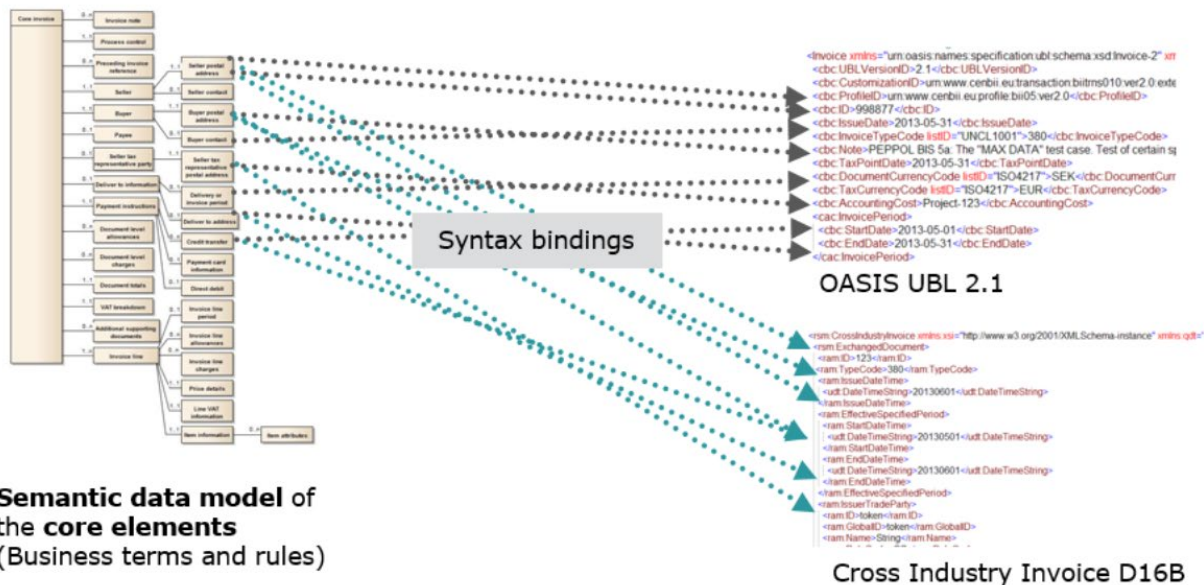

Syntax binding – Semantic model → Syntax

ID	Level	Card.	BT	Desc.	DT	Path	Type	Card.	Match	Rules
BT-1	1	1..1	Invoice number	A unique identification of the Invoice.	I	/Invoice/cbc:ID	I	1..1		
BT-2	1	1..1	Invoice issue date	The date when the Invoice was issued.	D	/Invoice/cbc:IssueDate	D	1..1		
BT-3	1	1..1	Invoice type code	A code specifying the functional type of the Invoice.	C	/Invoice/cbc:InvoiceTypeCode	C	0..1	CAR-2	
BT-5	1	1..1	Invoice currency code	The currency in which all Invoice amounts are given, except for the Total VAT amount in accounting currency.	C	/Invoice/cbc:DocumentCurrencyCode	C	0..1	CAR-2	
BT-6	1	0..1	VAT accounting currency code	The currency used for VAT accounting and reporting purposes as accepted or required in the country of the Seller.	C	/Invoice/cbc:TaxCurrencyCode	C	0..1	SEM-2	

Syntax binding – Syntax → Semantic model

Path	Card.	ID	Level	Card.	BT	Desc.	DT
/Invoice							
/Invoice/cbc:CustomizationID	0..1	BT-24	2	1..1	Specification identifier	An identification of the specification containing the total set of rules regarding semantic content, cardinalities and business rules to which the data contained in the instance document conforms.	I
/Invoice/cbc:ProfileID	0..1	BT-23	2	0..1	Business process type	Identifies the business process context in which the transaction appears, to enable the Buyer to process the Invoice in an appropriate way.	T
/Invoice/cbc:ID	1..1	BT-1	1	1..1	Invoice number	A unique identification of the Invoice.	I
/Invoice/cbc:IssueDate	1..1	BT-2	1	1..1	Invoice issue date	The date when the Invoice was issued.	D
/Invoice/cbc:DueDate	0..1	BT-9	1	0..1	Payment due date	The date when the payment is due.	D
/Invoice/cbc:InvoiceTypeCode	0..1	BT-3	1	1..1	Invoice type code	A code specifying the functional type of the Invoice.	C

Not a simple pair matching game

- Not all business terms can be mapped to a single element, often qualifiers are necessary
- The syntaxes have different structures and order of elements
- The syntaxes may have different cardinalities or even datatypes

- The syntax mappings have additional and separate validation rules



XML validation mechanisms

Martin Forsberg
DIGIT

Schematron

- Rule based validation language for XML documents
- ISO-standard
- Can test dependencies between elements/attributes such as:
 - If Invoice contains a VAT amount, then the Supplier VAT-number must be stated
- Advanced functions
 - Invoice Total Amount = Sum of (Invoice Line Amount + charges – Allowances)
 - Check-sum validation of GLNs, GTINs...
- Gives meaningful error messages
- Can be used to decouple code list values from XML-schema

The structure of a typical validation rule in Schematron

- Context – The element to be tested
- Assertion – The logical statement/rule to evaluate
 - If true – everything is ok, continue to next test
 - If false – rule violation!
- Message
 - Normally the rule text in natural language
- Flag
 - Often used flags:
 - fatal, warning och information
 - Fatal – violations against “SHALL/MUST”-rules
 - Warning – violations against SHOULD-regler
 - Information – highlights something which is not necessarily an error
 - “Element ABC should only be used if a bilateral agreement exists”

Example

```
<rule context="//ubl:Invoice/cac:TaxTotal | //cn:CreditNote/cac:Taxtotal">
  <assert test="(xs:decimal(child::cbc:TaxAmount) =
    round((sum(cac:TaxSubtotal/xs:decimal(cbc:TaxAmount)) * 10 * 10)) div 100)
    or not(cac:TaxSubtotal)"
    flag="fatal"
    id="BR-CO-14">[BR-CO-14]-Invoice total VAT amount (BT-110) = Σ VAT category tax amount (BT-117).</assert>
</rule>
```

- 1) context – which element will trigger the rule
- 2) assertion – the rule as a logical statement
- 3) flag – severity of the rule
- 4) id – A unique identifier of the rule
- 5) Rule text

Typical validation steps with schematron

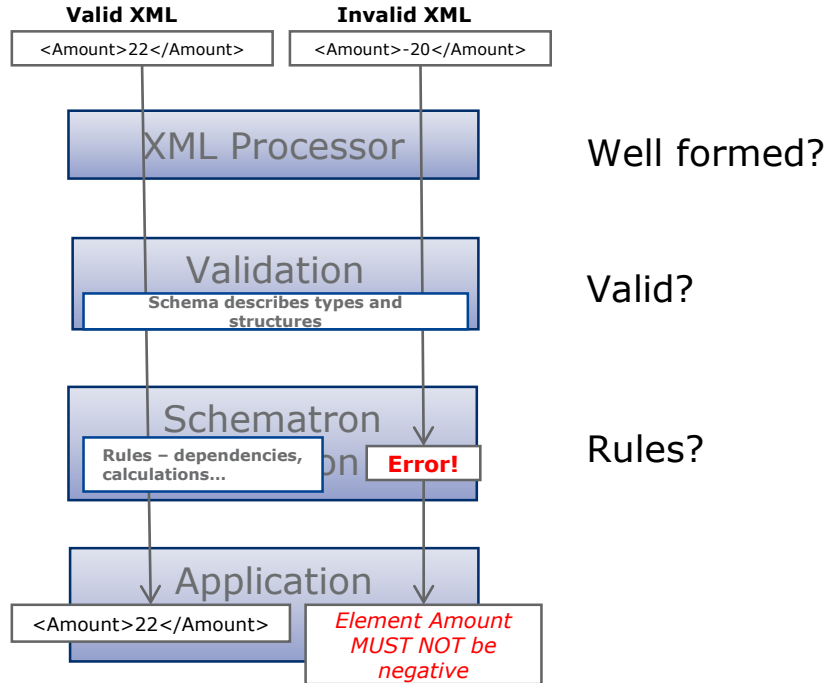

Which validation artefacts are used?

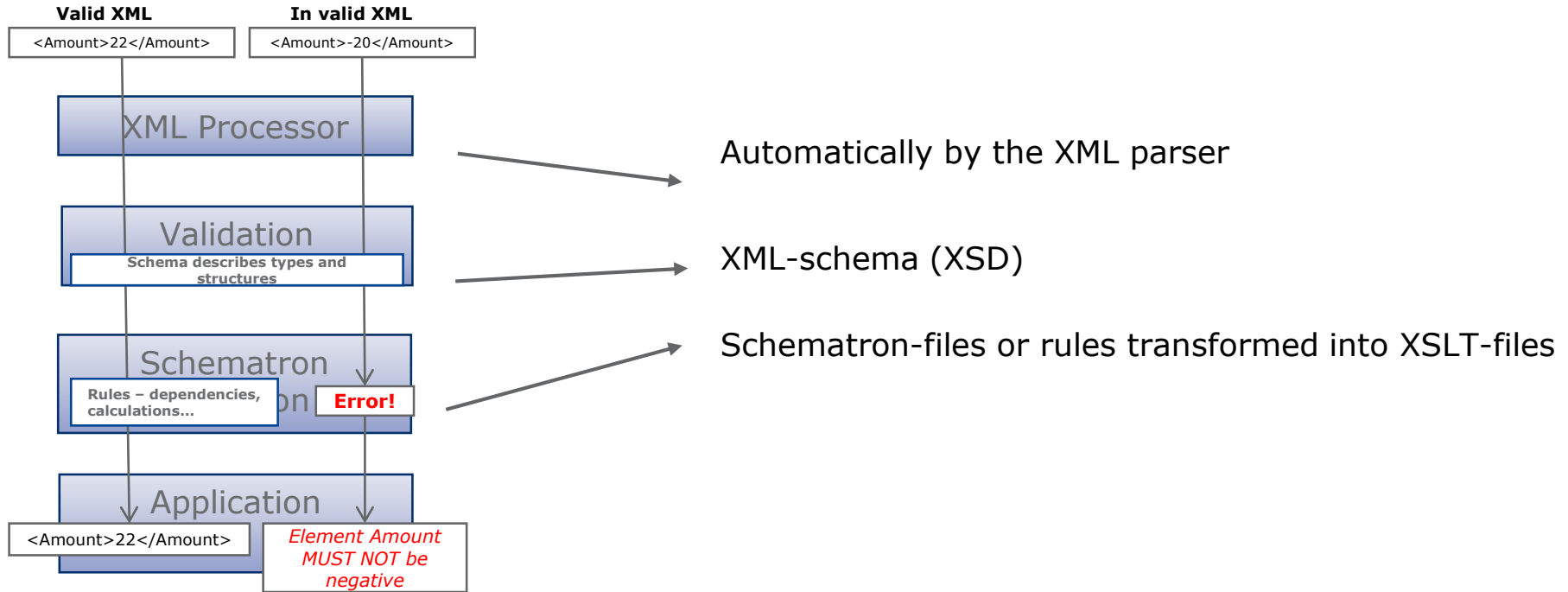

Validation services uses all levels of test artefacts

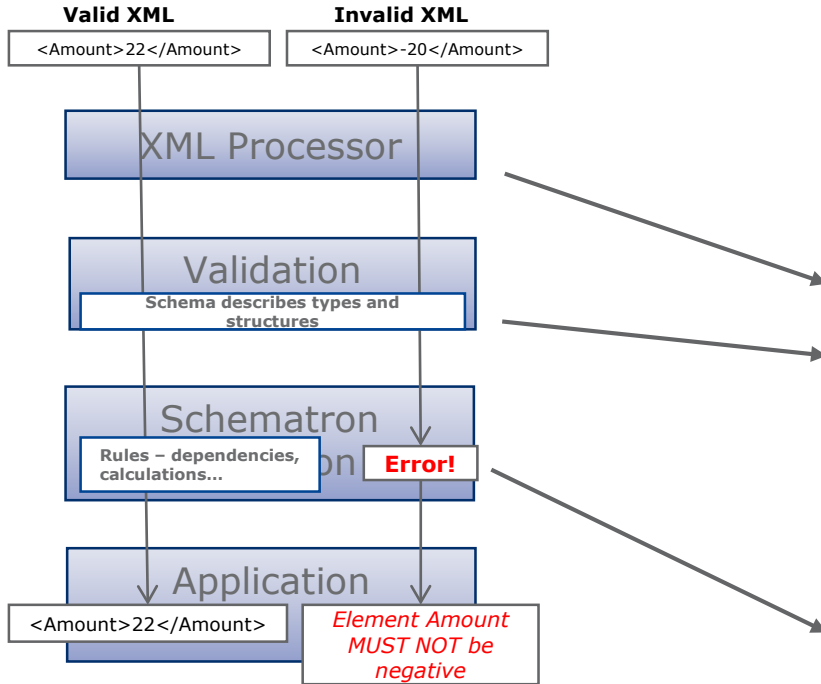

SFT! Start Additional Info Switch to Swedish Log out

Report

View as PDF

Filename: Svefaktura-Tom OrderlineReference.xml

Document Types

Description	Matched	Info	Warning	Fatal
XML Structural Validation	Yes	0	0	0
XML Schema	Yes	0	0	1
Additional rules	Yes	0	2	0
Business rule 2	Yes	0	0	0

XML Structural Validation

XML Schema

Flag	Message	Location
fatal	In content of element <InvoiceLine>: The content model does not allow element <Q[...eComponents:1:0]Items> to appear immediately after element <Q[...eComponents:1:0]OrderLineReference>. The following elements would be valid here, all in namespace urn:sfti:CommonAggregateComponents:1:0: AllowanceCharge, DespatchLineReference, Delivery, Item.	Line -1, character -1

Additional rules

Flag	Message	Location
warning	Optional xml-elements should not be stated if empty (no value inside the element).	/Invoice[1]/InvoiceLine[1] /OrderLineReference[1]/
warning	Optional xml-elements should not be stated if empty (no value inside the element).	/Invoice[1]/InvoiceLine[1]/Items[1]/

Mentimeter

www.menti.com

Enter #69 50 89





Usage specifications and compliance

Martin Forsberg
DIGIT

Compliance and conformance - The European standard defines these concepts

Compliant

some or all features of the core invoice model are used and all rules of the core invoice model are respected



Core Invoice Usage Specifications

Conformant

all rules of the core invoice model are respected and some additional features not defined in the core invoice model are also used



Extensions

From article 7 in the directive

Receipt and processing of electronic invoices

*Member States shall ensure that contracting authorities and contracting entities receive and process electronic invoices which **comply** with the European standard on electronic invoicing whose reference has been published pursuant to Article 3(2) and with any of the syntaxes on the list published pursuant to Article 3(2).*

Core – something in common

IMPORTANT

An invoice which follows a CIUS
MUST ALWAYS also be compliant
towards the (non-restricted)
norm.

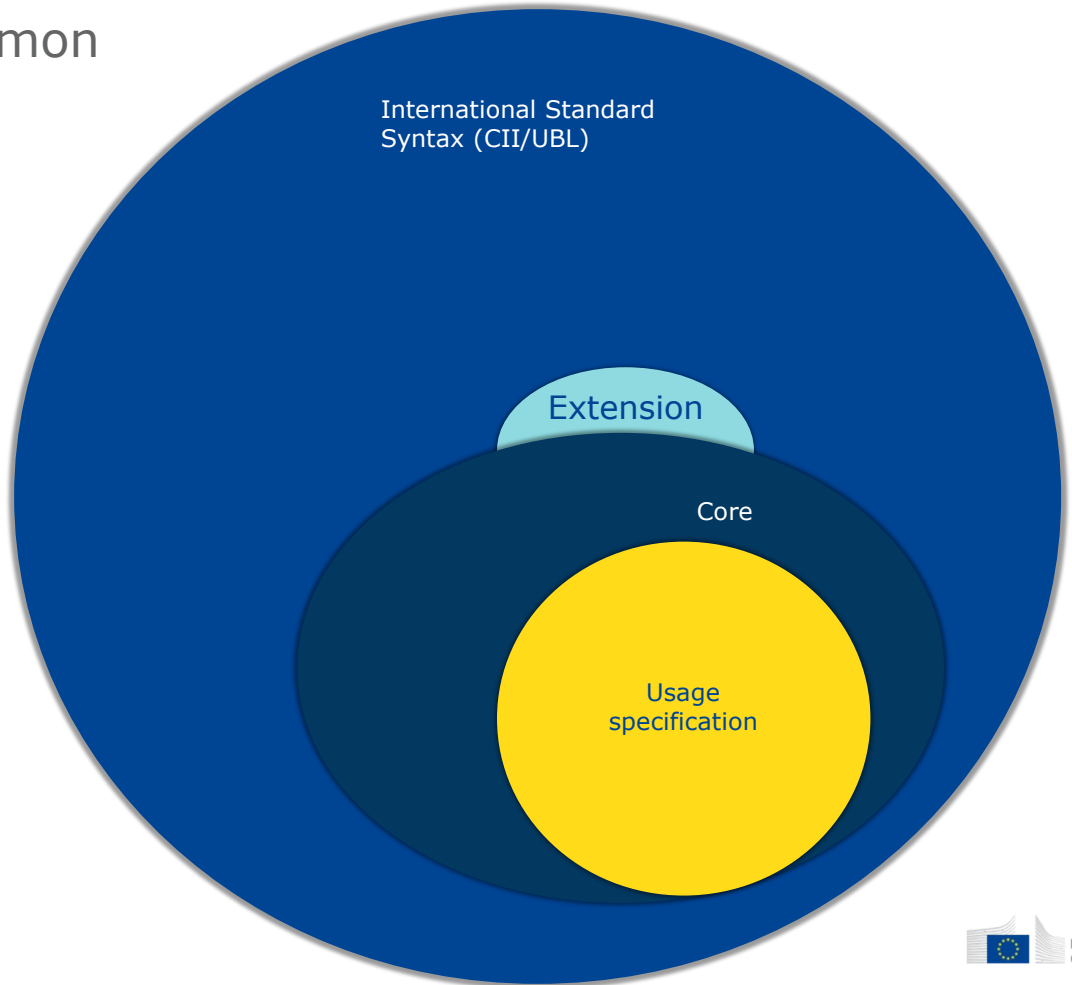

Requirements for the contracting authorities/entities

From article 7

Receipt and processing of electronic invoices

*Member States shall ensure that contracting authorities and contracting entities **receive and process electronic invoices which comply with the European standard on electronic invoicing** whose reference has been published pursuant to Article 3(2) and with any of the syntaxes on the list published pursuant to Article 3(2).*

Claiming compliance towards the norm

Compliance of sending or receiving party

*A receiving party may only claim compliance to the core invoice model if he accepts invoices that comply with the core invoice model in general, **or with a CIUS**, that is itself compliant with the core invoice model.*

What is allowed to restrict in a Core Invoice Usage Specification

- “Forbid” optional elements 0..n/0..1 → 0..0
- Make definition narrower
- Add synonyms or explanatory text
- Make optional element mandatory
- Limit allowed number of repetitions
- Change data type to narrower representation (alphanumeric → numeric)
- Limited allowed code values
- Add additional business rules or make existing more restrictive
- Restrict field lengths
- Require certain formatting on values
- Restrict number of decimals/fractions

IMPORTANT

An invoice which follows a CIUS **MUST ALWAYS** also be compliant towards the (non-restricted) norm.

A few scenarios

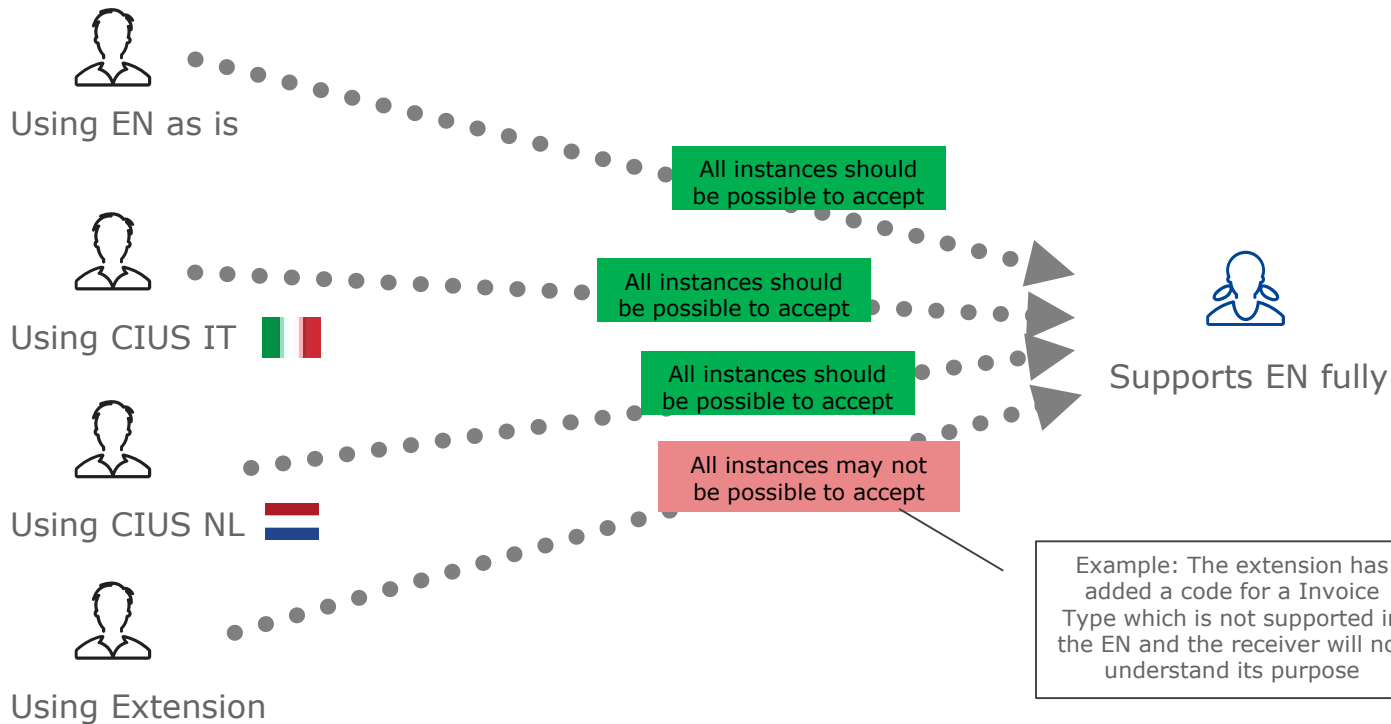

Assuming the invoices are conformant against its specification (EN/CIUS/Extension)

A few more scenarios

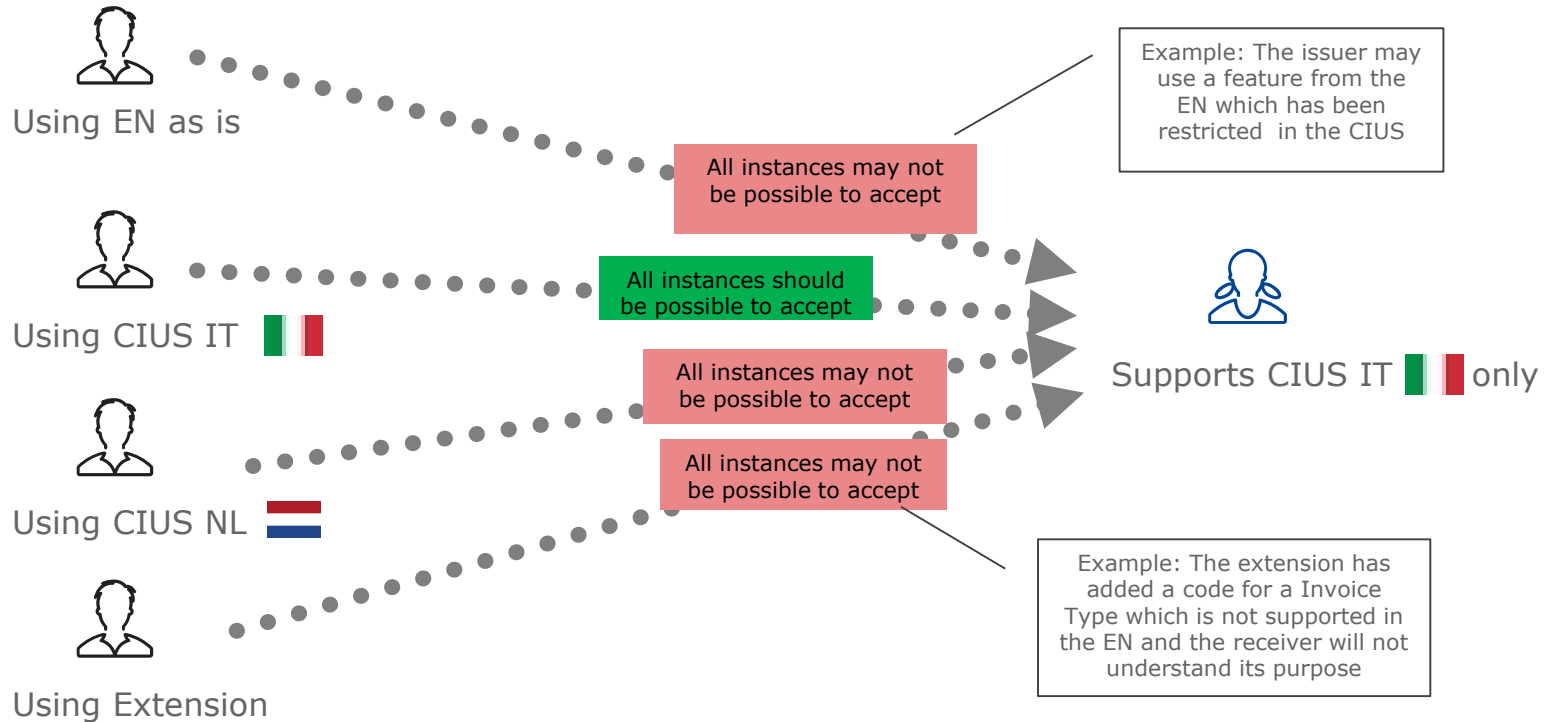

Assuming the invoices are conformant against its specification (EN/CIUS/Extension)

SPACE SHORTCUTS

CEF Knowledge Base

PAGE TREE

- > eInvoicing news & events
- > Forum
- > Contribute
 - > CEF eInvoicing Implementation Work
 - Guidance Paper for EU public admini:
 - > eInvoicing Pioneer Group
 - **Community-driven Registry of CIU**
 - Catalogue of Good Practices to supp
 - > Older posts (CONTRIBUTE)
 - > Follow-up actions after the CEF elnvc
- > Archive
- Meta
- Links

Community-driven Registry of CIUS (Core Invoice Usage Specifications) and Extensions

Created by Ines COSTA, last modified by Philip HELGER on Oct 29, 2018

Topic	Registry of CIUS (Core Invoice Usage Specifications) and Extensions
Excerpt	This page aims to give the eInvoicing community the opportunity to share the ongoing and planned initiatives across Member States and sectors to create CIUS and Extensions on the European standard on eInvoicing.
Status	OPEN
Deadline	Ongoing

Provide information on CIUS and Extensions

The table below aims to give the eInvoicing community the opportunity to share the ongoing and planned initiatives across Member States and sectors to create CIUS and Extensions on the European standard on eInvoicing. The content is community-driven and the contributors take the sole responsibility of the information shared. Please note that the information available does not have an authoritative character.

We invite you to contribute to build on the information available about the CIUS and Extensions on the European standard on eInvoicing by filling the table below:

Name	Type	Country	Sector	Purpose of the CIUS or Extension	Publisher	Governor	Underlying specification	Further info	Status	Contact
OpenPEPPOL BIS 3.0 5A	CIUS	Any	Any	Restricts the business process scope of the EN with reference to BIS2 business processes.	OpenPEPPOL	OpenPEPPOL	EN16931	http://docs.peppol.eu/poacc/billing/3.0/	ACTIVE	@Olav Astad KRISTIANSEN
Icelandic national CIUS	CIUS	IS	Any	Applies national regulations and imposes data format to payment instructions when using national payment clearing services.	IST	ISgov	PEPPOL BIS 3.0 5A	http://www.stadlar.is/stadlastarf/fagstadlarad-i-upplysingataekni.aspx	DEVELOPMENT	@Georg BIRGISSON
Austrian national CIUS	CIUS	AT	Any	Apply national regulations	BRZ	BRZ	EN16931	Publication on eRechnung.gv.at asap	ACTIVE	@Philip HELGER
Austrian government CIUS	CIUS	AT	Any	Additional regulations only applying to the mandatory government interface. This CIUS builds on top of the Austrian national CIUS!	BRZ	BRZ	AT national CIUS	Publication on eRechnung.gv.at asap	ACTIVE	@Philip HELGER
Energy elnvoice	Extension	NL	Energy	Enables the addition of information concerning: 1) Measured energy use, including meter info, meter readings, fuel type etc. 2) VAT specification for more than one party, which is a consequence of the so called supplier-centered model.	Energy elnvoice steering committee	Energy elnvoice steering committee	Simplerinvoicing (SI-UBL)	https://energie-efactuur.nl/en/	DEVELOPMENT	Wouter van den Berg (TNO)
Italian national CIUS	CIUS	IT	Any	Applies national regulations and restricts data format in compliance with elnvoice national format (FatturaPA)	AgID, AdE	AgID, AdE	EN16931	http://www.agid.gov.it/agenda-digitale/pubblica-amministrazione/cef-telecom-einvoicing-eigor	DEVELOPMENT	Fabio MASSIMI
NLCIUS	CIUS	NL	Any	Applies national regulations and conventions. The purpose of the NLCIUS is to prevent the need for any other NL	NEN / SMef	NEN / SMef	EN16931	NLCIUS is a joint initiative of government, industry and	ACTIVE	Michiel Stornebrink (TNO)

General rules and country-qualified rules

- A **general rule** applies for all invoices
 - The rule is triggered by the existence of a specific business term

Rule text from the standard

In an Invoice line where the Invoice item VAT category code (BT-151) is "Export outside the EU" the Invoiced item VAT rate (BT-152) shall be 0 (zero).

Context (what triggers the rule)

Existence of

InvoiceLine/Item/ClassifiedTax/CategoryCode='XYZ'

Example rule text from a CIUS

The Seller Name must not have more than 50 characters

Context (what triggers the rule)

Existence of

Seller/Name

- A **country-qualified rule** applies only for invoices issued in a specific country
 - The rule is triggered by the given country code of the seller

Example rule text from a Country specific CIUS

When the Seller is Swedish, the Legal Registration Number must be numeric with 10 digits.

Context (what triggers the rule)

Existence of

Seller/Address/CountryCode='SE'

AND existence of

Seller/LegalRegistrationNumber

Layers of validation rules in PEPPOL

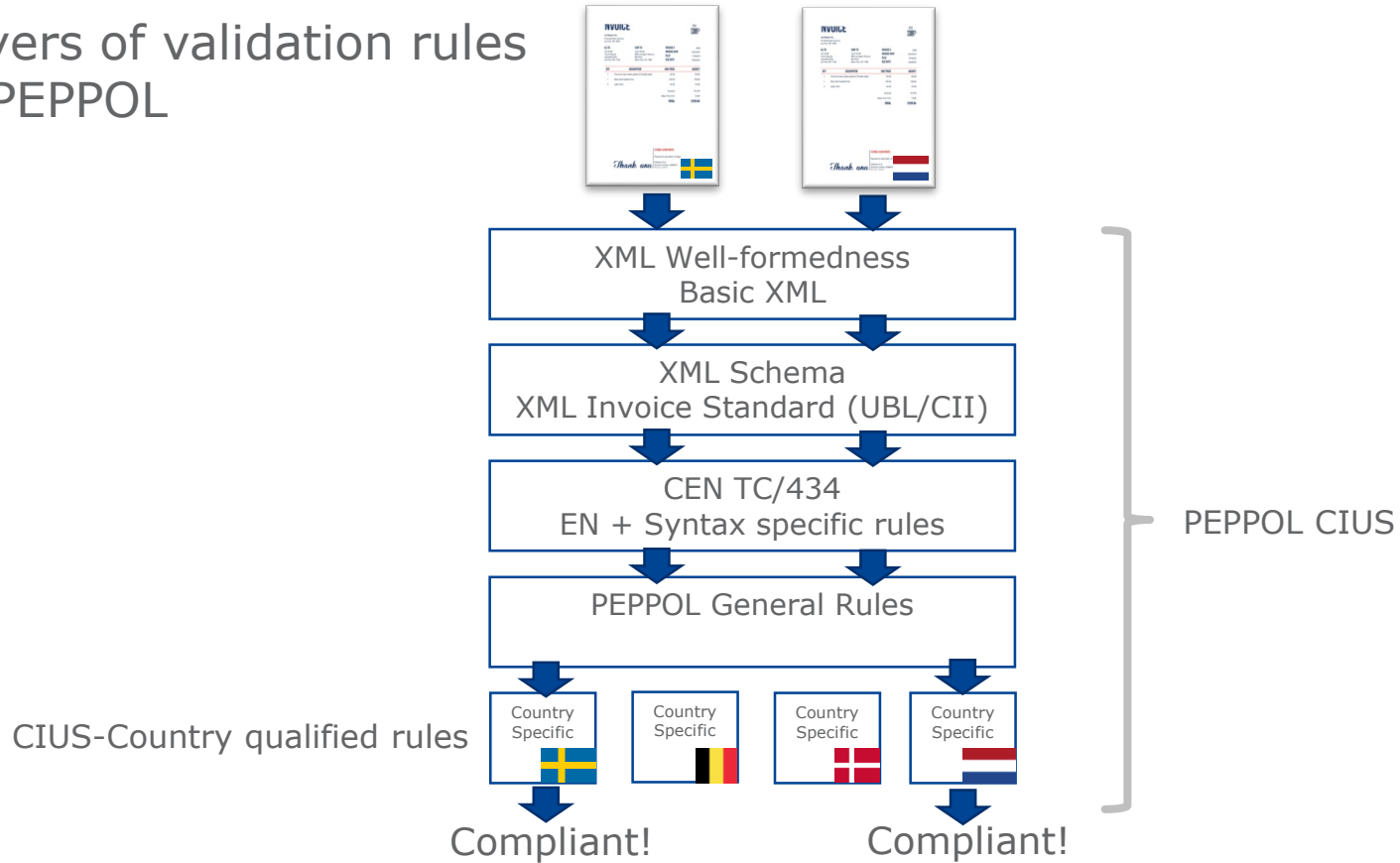

National rules in PEPPOL CIUS

To avoid creation of national CIUS'es:

- affected based on the country of the seller.
- Don't affect invoices issued in other countries.
- PEPPOL Authority responsible

Appendix C: National rules

The following rules have been defined by PEPPOL Authorities in addition to the rules for [PEPPOL BIS](#) in general. These rules are affected based on the country of the seller, and **will not affect invoices issued in other countries.** They apply in **all** profiles that use this transaction specification.

National rules are provided by each country's PEPPOL Authority, and if you need any changes or additions to these rules, please contact your PEPPOL Authority.

Table 18. National transaction business rules

Rule	Message/Context/Test
DK-R-001 (warning)	For Danish suppliers when the Accounting code is known, it should be referred on the Invoice.
	ubl-creditnote:CreditNote ubl-invoice:Invoice
	not(cac:AccountingSupplierParty/cac:Party/cac:PostalAddress/cac:Country/cbc:IdentificationCode = 'DK' and (normalize-space(cbc:AccountingCost/text()) = ''))
DK-R-002 (fatal)	Danish suppliers MUST provide legal entity (CVR-number).
	ubl-creditnote:CreditNote ubl-invoice:Invoice
	not(cac:AccountingSupplierParty/cac:Party/cac:PostalAddress/cac:Country/cbc:IdentificationCode = 'DK' and (normalize-space(/cac:AccountingSupplierParty/cac:Party/cac:PartyLegalEntity/cbc:CompanyID/text()) = ''))

Example - Swedish rules

- Formats for VAT and organisation numbers
- Swedish VAT rates
- Tax registration F-Skatt
- Payment means Bankgiro and Plusgiro

SE-R-001 For Swedish suppliers, Swedish VAT-numbers must consist of 14 characters.	fatal
SE-R-002 For Swedish suppliers, the Swedish VAT-numbers must have the trailing 12 characters in numeric form	fatal
SE-R-003 Swedish organisation numbers should be numeric.	fatal
SE-R-004 Swedish organisation numbers consist of 10 characters.	fatal
SE-R-005 For Swedish suppliers, when using Seller tax registration identifier, 'Godkänd för F-skatt' must be stated	fatal
SE-R-006 For Swedish suppliers, only standard VAT rate of 6, 12 or 25 are used	fatal
SE-R-007 For Swedish suppliers using Plusgiro, the Account ID must be numeric	warning
SE-R-008 For Swedish suppliers using Bankgiro, the Account ID must be numeric	warning
SE-R-009 For Swedish suppliers using Bankgiro, the Account ID must have 7-8 characters	warning
SE-R-010 For Swedish suppliers using Plusgiro, the Account ID must have 2-8 characteres	warning
SE-R-011 For Swedish suppliers using Swedish Bankgiro or Plusgiro, the proper way to indicate this is to use Code 30 for PaymentMeans and FinancialInstitutionBranch ID with code SE:BANKGIRO or SE:PLUSGIRO	warning



Experiences from implementers

Martin Forsberg
DIGIT

Challenges in implementation

(Based on a survey and dialog with 25 Nordic implementers)

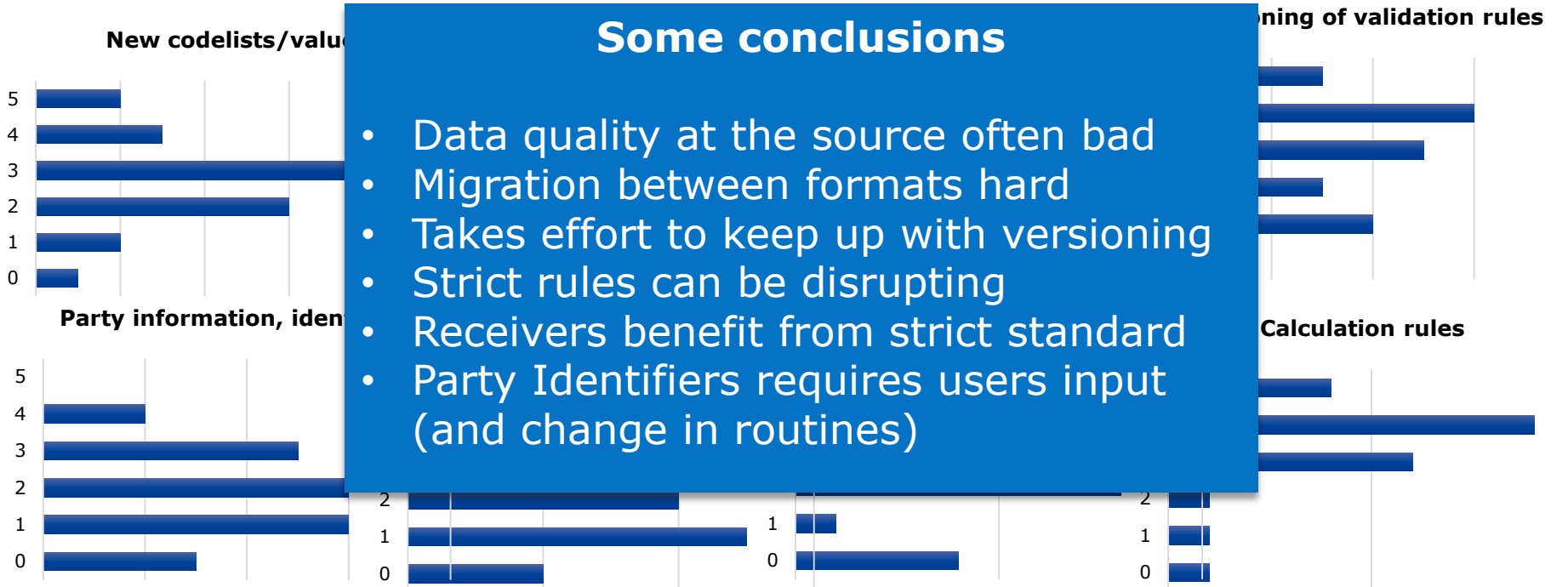

5 = very challenging, 0 = not challenging

Supporting tools

- All implementers are regularly using validation services
- Most of them have been in contact with some support channel (CEF, SFTI, others)
- Most of them have attended trainings and seminars
- Few are using online forums



Interconnectivity – cross border and on national level

Martin Forsberg

DIGIT

Areas covered by the standard

The European Standard

Steps in the process

Information to exchange

Technical format

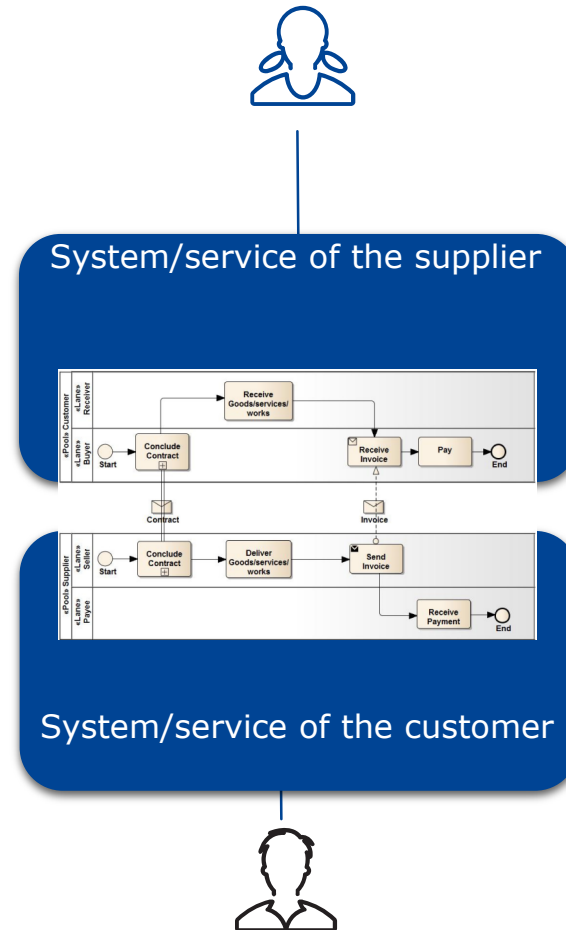
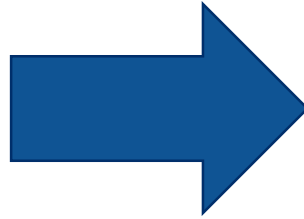

Necessary functionality

Generation of the eInvoice

- ERP/Accounting system, web-portal or specialized services

Processing and reception

- Workflow for simplified processing
- Straight through processing
- Integration with ERP/Accounting

generation
transmission
reception
processing

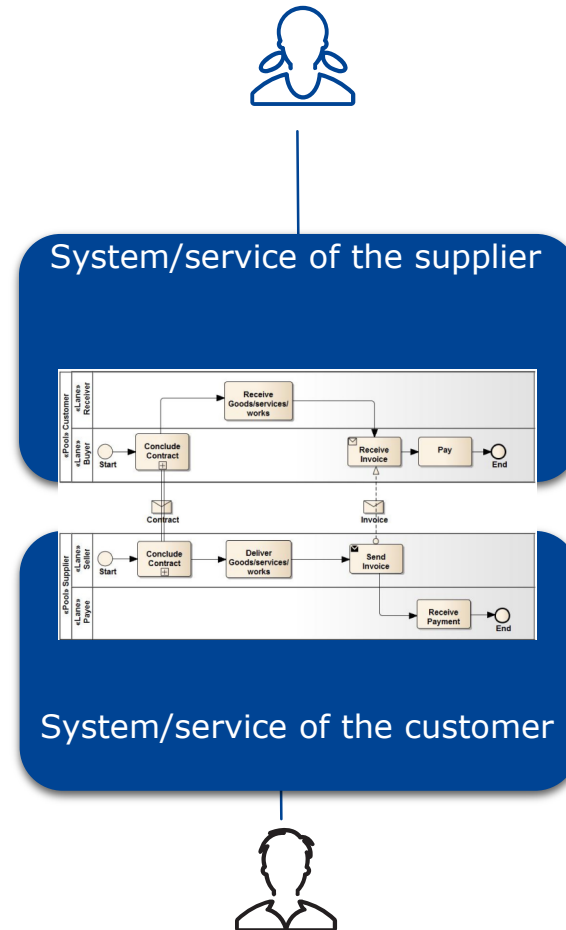

Areas covered by the standard

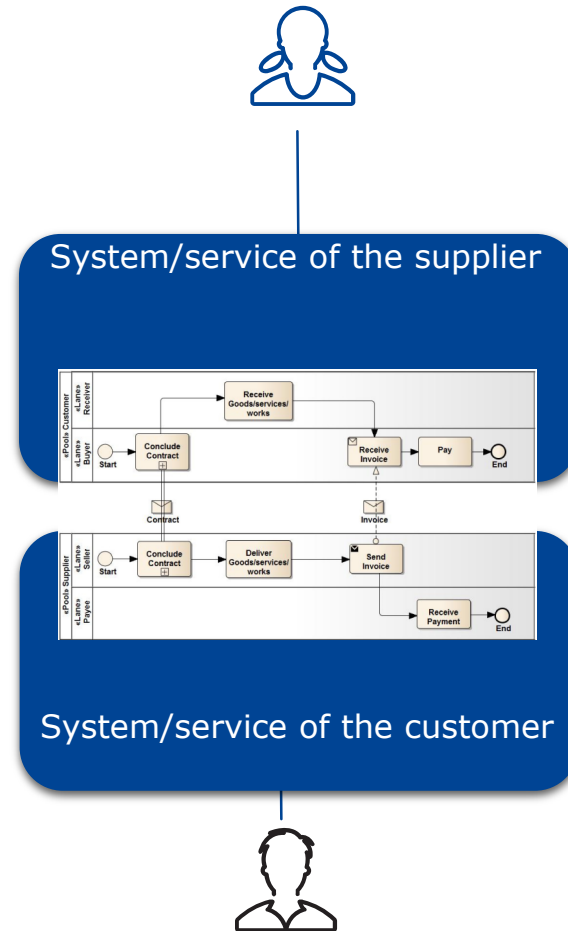
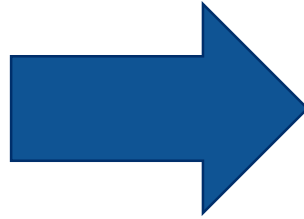
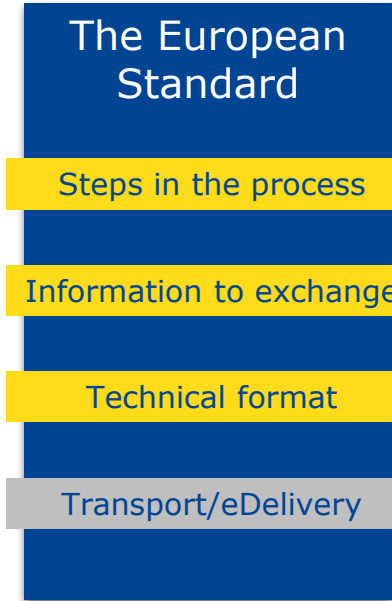

Transmission of the eInvoice

Transmission of the eInvoice

- Many different models for exchange

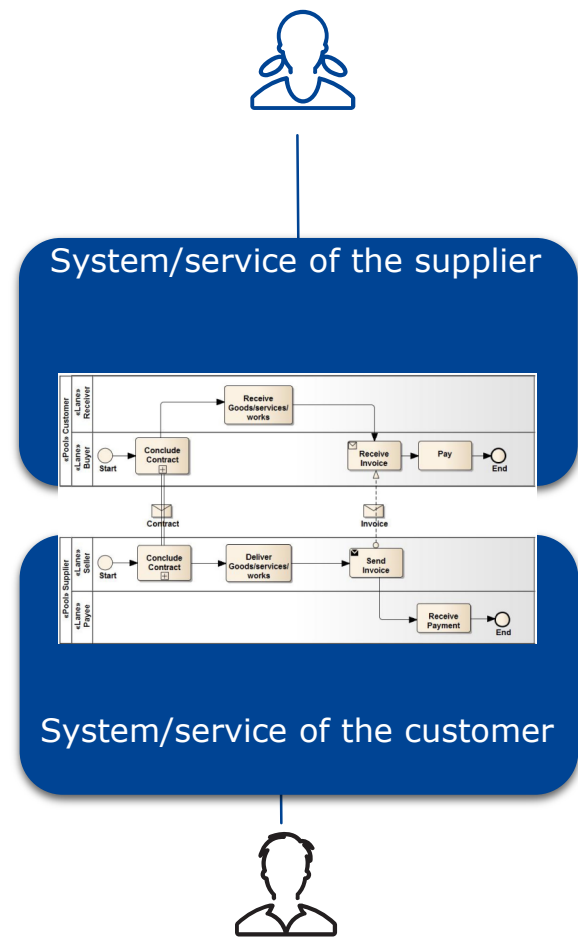

*generation
transmission
reception
processing*

Some countries lack of clear policy on eDelivery - a big challenge for the suppliers

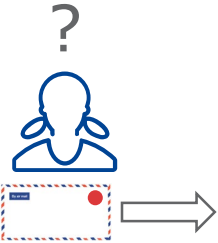

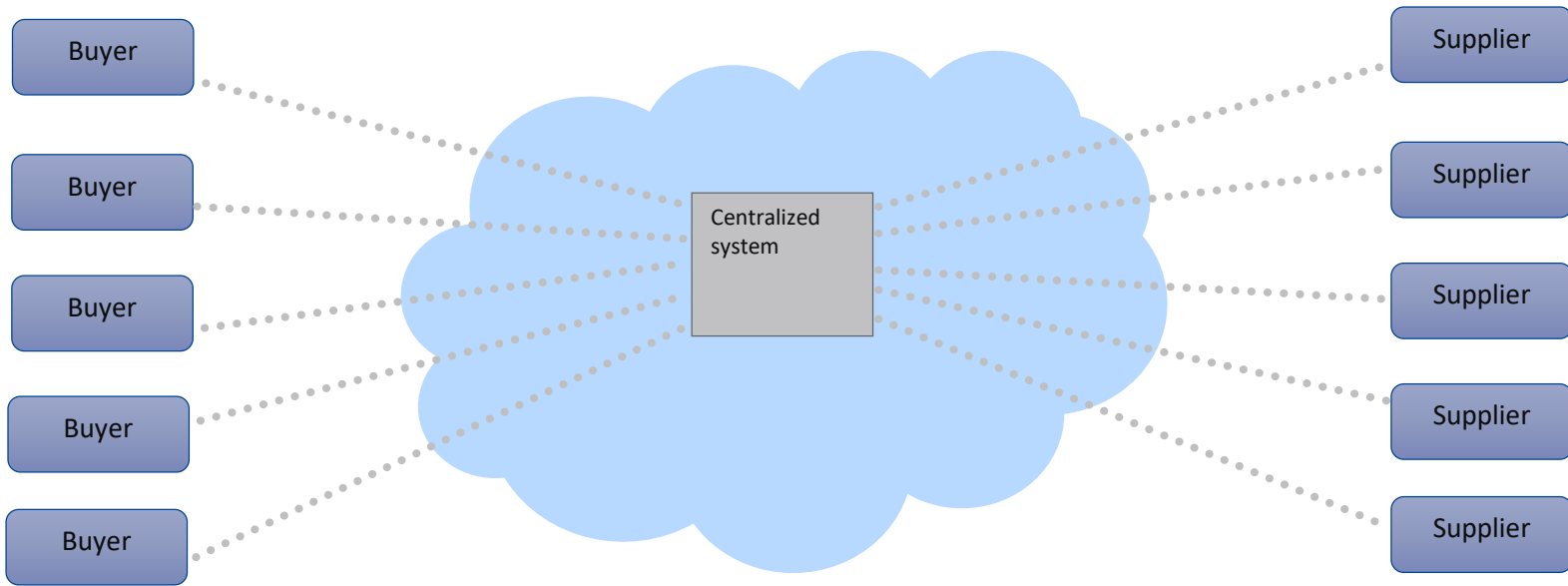

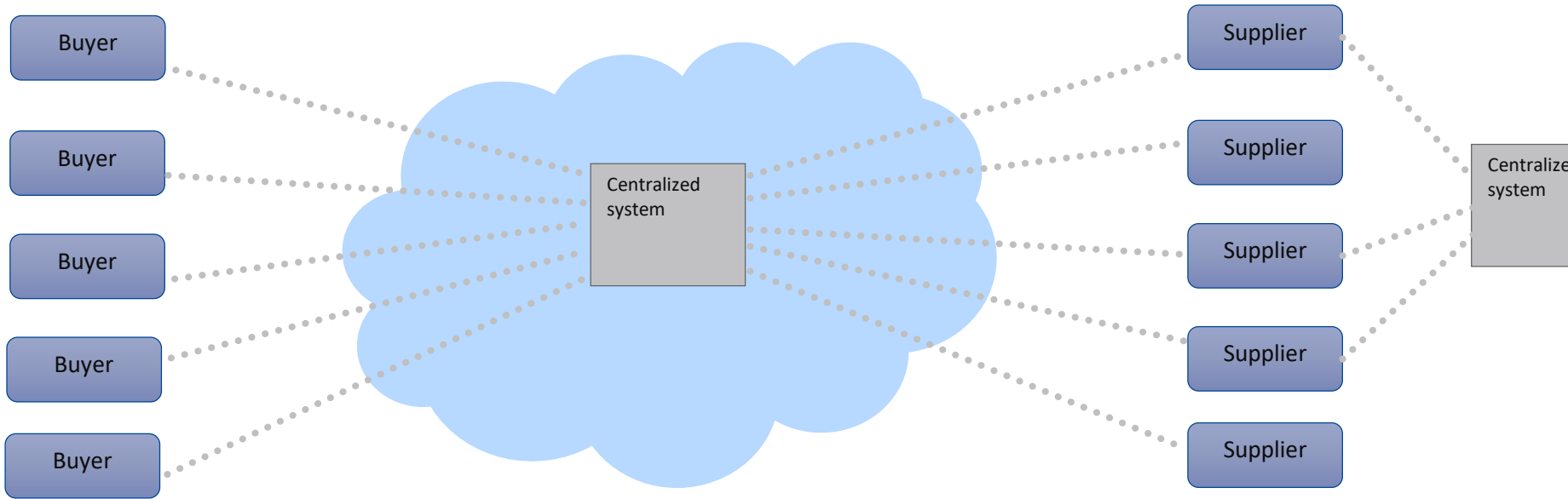

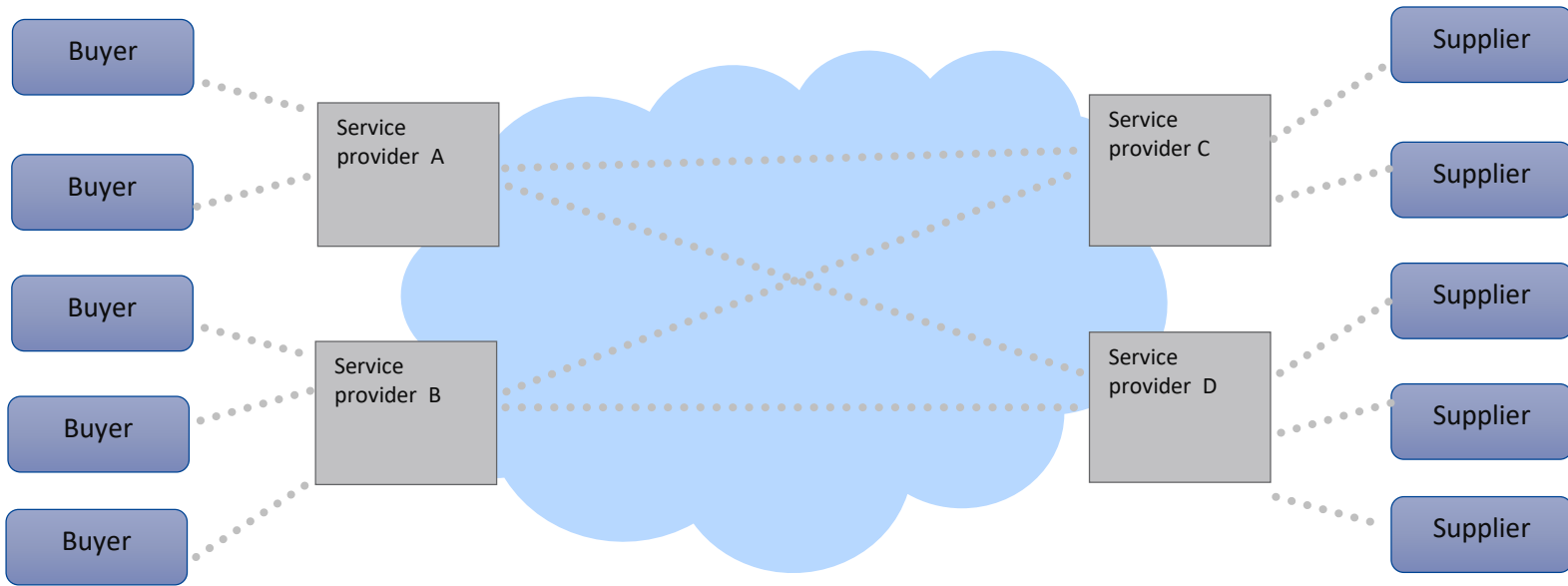

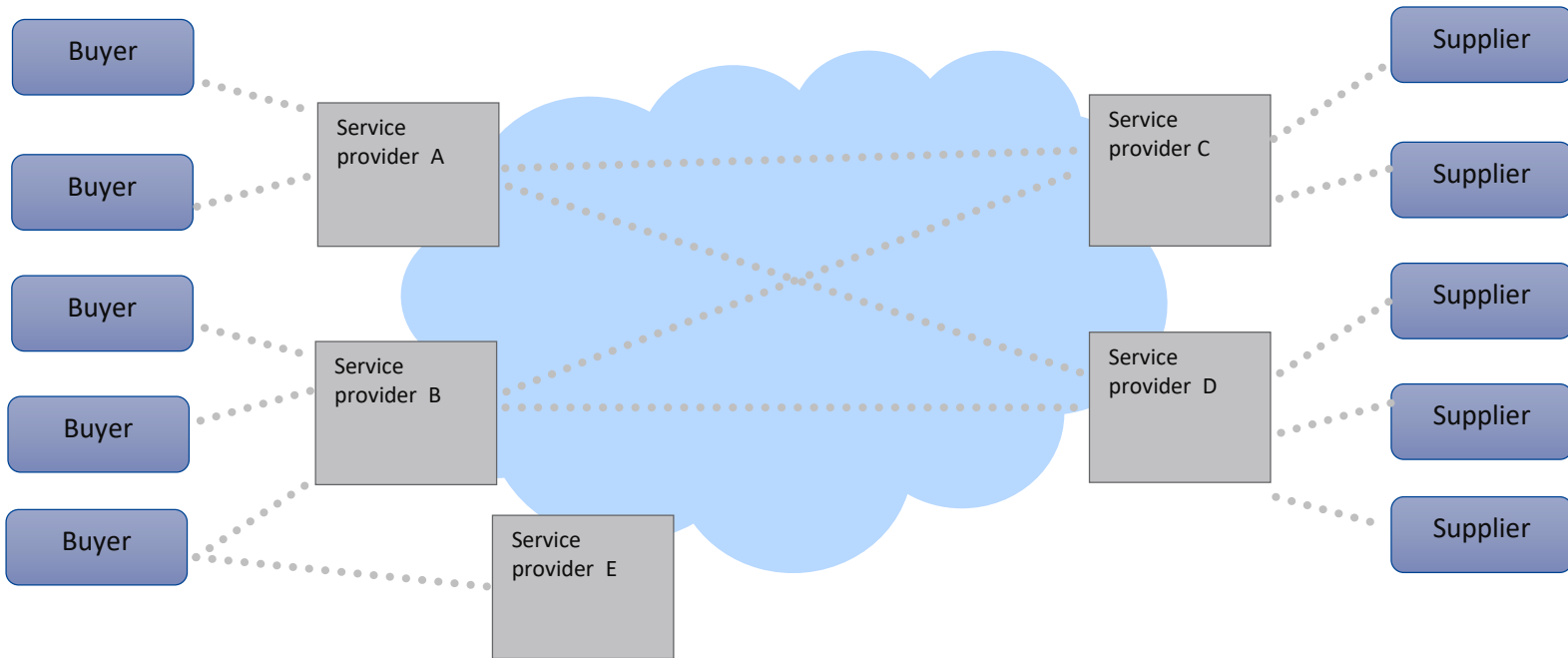

eDelivery
Infrastructure where
Buyers and Sellers can
exchange
e-documents

Specifications for
electronic invoice,
order, catalogue...

Non-for-profit
organisation which
maintains and
governs

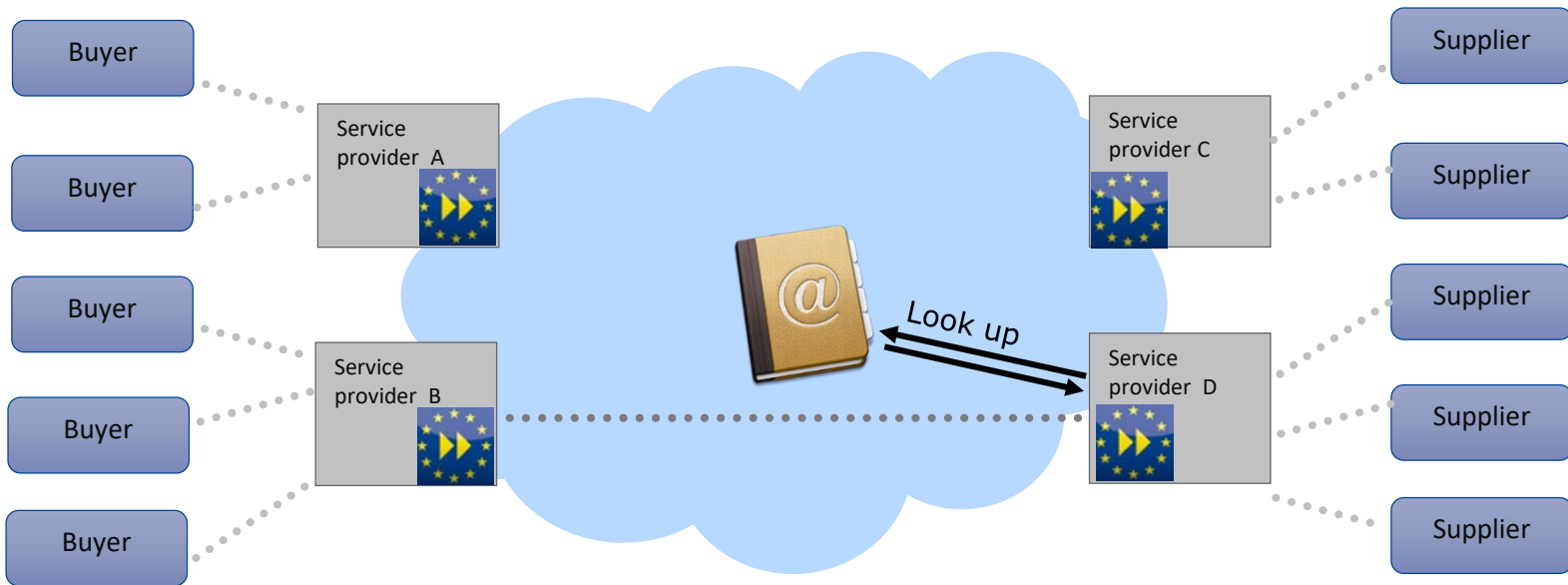

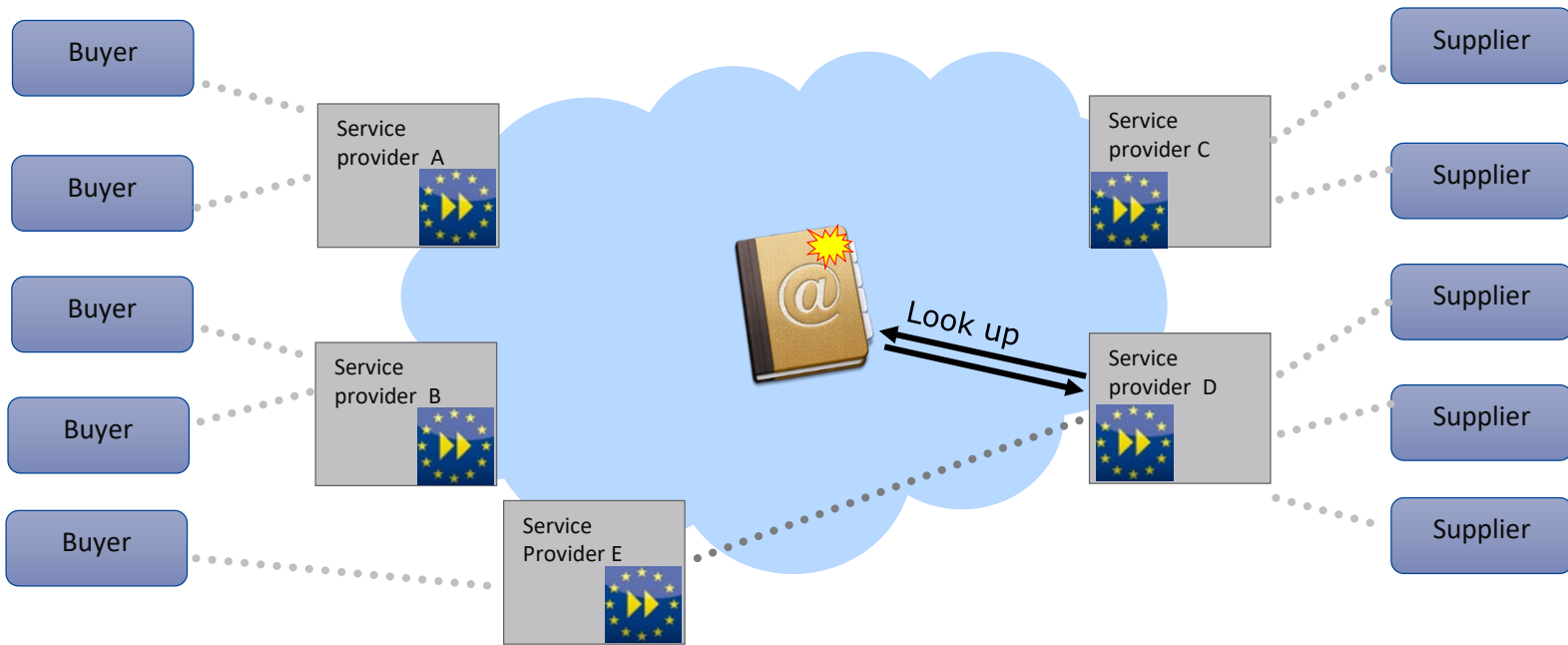

INVOICE



East Repair Inc.
455 Amsterdam Avenue
New York, NY 1023

BILL TO

John Smith
2 Court Square
Long Beach City

SHIP TO

John Smith
654 Lexington Avenue
6th Floor
New York, NY 10022

INVOICE

00234

INVOICE DATE

03/25/2014

P.O.#

1742/2014

DUE DATE

04/09/2014

QTY	DESCRIPTION	UNIT PRICE	AMOUNT
1	Front and rear brake cables & Throttle cable	56.00	56.00
1	New set of pedal arms	182.00	182.00
3	Labor 3hrs	25.00	75.00
Subtotal			313.00
Sales Tax 5.0%			15.65
TOTAL			\$328.65

Buyer

- Name and address
- Party identifiers

Delivery location

- Address
- Identifiers

Electronic address identifier (EndpointID)

- "PEPPOL-ID" (GLN, DUNS etc)



PEPPOL-ID Receiver: 0007:5512345672
PEPPOL-ID Sender: 0007:2020332423

0007 : 5512345678

Type code for
Swedish
organisation
number

The actual number



GÖTEBORGS UNIVERSITET

Gothenburg 2016-09-23

Billing the University of Gothenburg

E-invoice

The University of Gothenburg prefers e-invoicing. Our suppliers can send e-invoices via PEPPOL, which enables European businesses to easily deal electronically with any European public sector buyer in their procurement process. Our PEPPOL-id is 0007:2021003153.



KUSTBEVAKNINGEN
SWEDISH COAST GUARD

Q Sea

Listen

[About us](#)

[Sustainable environment](#)

[Safety at sea](#)

[Cooperation](#)

[Technology](#)

[Education & Work](#)

[About this website](#)

[Command centre](#)

[Contact us](#)

[Invoicing](#)

[News - About us](#)

[Organisation](#)

[Printed material](#)

[Retrospect](#)

[Start page](#) / [About us](#) / [Invoicing](#)

Invoicing

The Swedish Coast Guard is gradually changing over to receiving only electronic invoices. The Swedish Coast Guard does not accept invoices in PDF format sent via e-mail. There are several ways in which to submit e-invoices:

Via PEPPOL

Our preferred method for receiving electronic invoices is via the PEPPOL network. The Swedish Coast Guard's electronic address in PEPPOL is 0007:2021003997.

Via the Swedish Coast Guard's invoice portal

If you are unable to send electronic invoices, you can use our invoice portal free of charge to register them manually. This solution is intended for smaller suppliers who only issue a few invoices. Log in and register at: fakturaportalen.se

SBDH

XML Envelope



```
<?xml version="1.0" encoding="UTF-8"?>
<StandardBusinessDocument
  xmlns="http://www.unece.org/cefact/namespaces/StandardBusinessDocumentHeader"
  xmlns:xs="http://www.w3.org/2001/XMLSchema">
  - <StandardBusinessDocumentHeader>
    <HeaderVersion>1.0</HeaderVersion>
    - <Sender>
      <Identifier Authority="iso6523-actorid-upis">0088:7315458756324</Identifier>
    </Sender>
    - <Receiver>
      <Identifier Authority="iso6523-actorid-upis">0088:4562458856624</Identifier>
    </Receiver>
    - <DocumentIdentification>
      <Standard>urn:oasis:names:specification:ubl:schema:xsd:Invoice-2</Standard>
      <TypeVersion>2.1</TypeVersion>
      <InstanceIdentifier>123123</InstanceIdentifier>
      <Type>Invoice</Type>
      <CreationDateAndTime>2013-02-19T05:10:10Z</CreationDateAndTime>
    </DocumentIdentification>
    - <BusinessScope>
      - <Scope>
        <Type>DOCUMENTID</Type>
        <InstanceIdentifier>urn:oasis:names:specification:ubl:schema:xsd:Invoice-2:1</InstanceIdentifier>
      </Scope>
      - <Scope>
        <Type>PROCESSID</Type>
        <InstanceIdentifier>urn:www.cenbii.eu:profile:bii04:ver2.0</InstanceIdentifier>
      </Scope>
    </BusinessScope>
  </StandardBusinessDocumentHeader>
  - <Invoice:Invoice xmlns="urn:oasis:names:specification:ubl:schema:xsd:Invoice-2"
    xmlns:Invoice="urn:oasis:names:specification:ubl:schema:xsd:Invoice-2"
    xmlns:cac="urn:oasis:names:specification:ubl:schema:xsd:CommonAggregateComponents-2"
    xmlns:cbc="urn:oasis:names:specification:ubl:schema:xsd:CommonBasicComponents-2">
    <cbc:UBLVersionID>2.1</cbc:UBLVersionID>
    ...
  </Invoice:Invoice>
</StandardBusinessDocument>
```

Contains all info necessary for a eDelivery Look-up

PEPPOL today

+200 Certified Access Points in **20** European countries, plus Singapore, Canada and USA. More than **150.000** e-Invoice receiving organizations connected. **60 million** e-invoices between APs in 2017.

12 PEPPOL Authorities

- Agency for Digital Italy (AgID) (Italy)
- Agency for Public Management and eGovernment (Difi) (Norway)
- Danish Business Authority (Denmark)
- Department of Health (UK)
- Department of Public Expenditure and Reform (Ireland)
- Federal Public Service Policy and Support (BOSA) (Belgium)
- Agency for Digital Government (DIGG) (Sweden)
- Free Hanseatic City of Bremen – KoSIT (Germany)
- Ministry of Economic Development (Poland)
- SimplerInvoicing (Netherlands)
- **Info-communications Media Development Authority (IMDA) (Singapore)**
- OpenPEPPOL AISBL

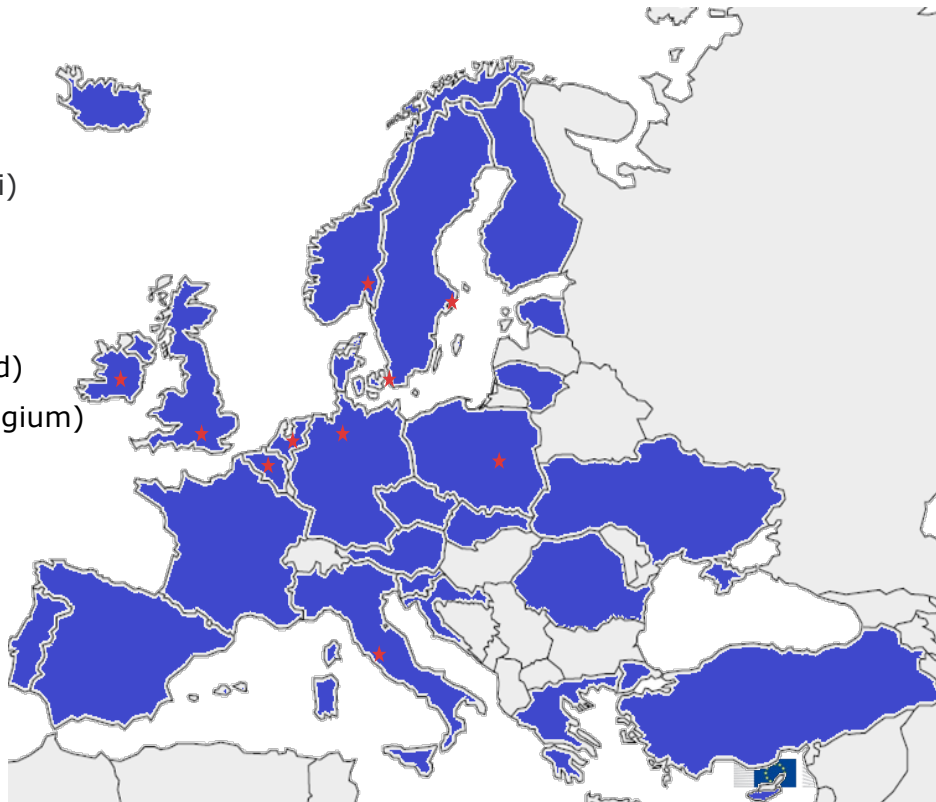

Number of receivers in PEPPOL

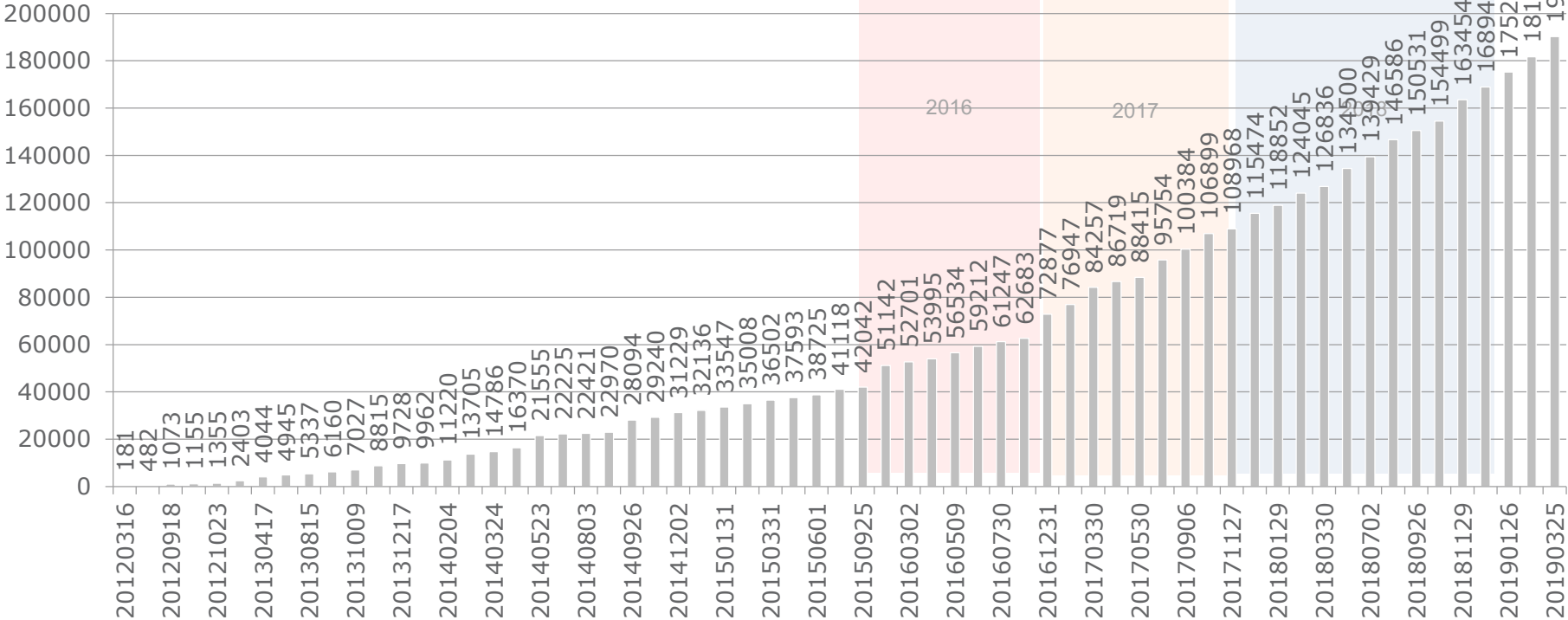

ZC Solution SRL	Italy	Consumer Cloud Technology Services Pte Limited	Singapore	Genesis IT AB	Sweden	Onetrail BV	Netherlands	Telemas AS	Estonia
216 Accountants B.V	Netherlands	Compello AS	Norway	Generix Group Benelux	Belgium	Oppgjorskontoret AS	Norway	Telenor Norge AS	Norway
AdValvas Europe	Belgium	Creдемтел S.p.A.	Italy	GHX UK	UK	Outsourcia AS Bakke	Norway	Tesisquare S.p.A	Italy
Advanced Business Software and Solutions	UK	Crediflow Försäljnings AB	Sweden	Goldman Solutions & Services Ltd.	Cyprus	Pagero	Sweden	TIE Kinetix	Netherlands
Advania Holding hf.	Iceland	Consp SpA (Italy)	Italy	GXS (OpenText)	USA	Pagero HBS GmbH	Germany	Tieto	Finland
Akssess Innkjøp (Prosjektservice AS)	Norway	crossinx GmbH	Germany	Hafslund Tellier AS	Norway	Pagero Norway	Norway	Tradeinterop	Netherlands
Akssespunkt Norge AS	Norway	CS Amed SRL	Italy	Hogia Business Products AB	Sweden	Palette Software AB	Sweden	Tradeshift	Denmark
Aliquid Italy	Italy	Daldata AS	Norway	Ibistic	Norway	Payt B.V.	Netherlands	Tradeshift AB	Sweden
Amesto Solutions Purchasing A/S	Norway	DataPost Pte Ltd	Singapore	IBM Corporation	USA	PaperLess Innovation Ltd.	Malta	Transalis Ltd.	UK
Azets Insight AS	Norway	Data Interchange	UK	IBM Danmark ApS	Denmark	Pearl Norge AS	Norway	Tripletex AS	Norway
Order2Cash – (Anachron B.V.)	Netherlands	Danish Business Authority (ERST)	Denmark	iEDI ApS	Denmark	PIMEC, Petita i Mitjana Empresa de Catalunya	Spain	True Commerce (Coventry) Ltd.	UK
Apix Messaging Oy	Finland	Dcode Websolutions AS	Norway	IFIN Sisstemi S.r.L. a socio unico	Italy	PinkRoccade Local Government BK.V.	Netherlands	TrueCommerce ApS Denmark	Denmark
Apro Consulting Services B.V.	Netherlands	DERWID.com GmbH	Austria	ILGE Sybscription Management BVBA	Belgium	PostNord (Strålfors Svenska AB)	Sweden	Truelink A/S	Denmark
Archiva S.r.L.	Italy	Desk Drive	Belgium	Implema AB	Sweden	PowerOffice Software AS	Norway	Tungsten Network Ltd.	UK
Archivium Srl	Italy	Digital Cab ApS	Denmark	In. Te. S.A.	Italy	PracBiz Pte Ltd	Singapore	Tyringe Konsult AB	Sweden
Arco Information N.V.	Belgium	Danish Business Authority (ERST)	Denmark	Inaras NV	Belgium	Projektservice AS	Norway	TX2 Concept	Singapore
At Work Systems	Norway	DocFlow Italia S.p.A.	Italia	InExchange Factorum AB	Sweden	Qvalia Group AB	Sweden	UNI MICRO AS	Norway
B2B Router (Invinet Sistemes)	Spain	Document Centric Solutions	Ireland	Infinite Sp. z.o.o.	Poland	Reknes AS	Norway	UnifiedPost	Netherlands
B4 value.net GmbH	Germany	Docuten (Enxendra Technologies)	Spain	Infocent S.p.A.	Italy	Resforma AS	Norway	Unimaze Software	Iceland
Babelway	Belgium	Dooxee S.p.A.	Italy	INPOSIA Solutions GmbH	Germany	Ricoh Netherlands B.V.	Netherlands	Unit4 Agresso	Norway
Basware	EU	Dynatos NV	Belgium	Integrasjonssystemer AS	Norway	S.A.T.A.	Italy	Upheads AS	Norway
BEAst AB	Sweden	DXC	UK	Intercent-ER	Italy			UPRC Greece	Greece
Billit	Belgium	Easy Systems B.V.	Netherlands					ValidatedID S.L.	Spain
BIZbrains A/S	Denmark	EC/DG DIGIT	Belgium					Van Meijel	Netherlands
Bluzor B.V.	Netherlands							Viaduct AB	Sweden
Brain2	Belgium							Virtualstock Ltd.	UK
Bundesrechenzentrum GmbH (BRZ)	Austria							Visma Labs	Sweden
Calvi Business Software BV	Netherlands	EDI Plus Ltd	UK	KBC Commercial Finance	Belgium	Science Warehouse Limited	UK	Visma Software International AS	Norway
Catalog360 Limited	UK	EDICOM CAPITAL S.L.	Spain	KMD Denmark	Denmark	SEEBURGER AG	Germany	Voxel Media S.L.	Spain
CEGEDIM	France	EDIGard AS	Norway	Kofax Sweden Services AB	Sweden	Seen Solution Srl	Italy	Wax Digital Ltd.	UK
Celtrino – EDI Factory	Ireland	EDISON S.A.	Poland	LBMX Inc.	Canada	Seres	France	Webware Internet Solutions GmbH	Germany
Centric Netherlands	Netherlands	Effektus AS	Norway	Liaison Technologies Oy	Finland	Seres SA	Spain	Workflow Management & Document Consulting Asia Pte Ltd	Singapore
CGI Sverige AB	Sweden	eFinans AS	Norway	Logiq AS	Norway	SIA S.p.A.	Italy	Xledger Labs AS	Norway
CloudOffice AS	Norway	Elcom	UK	Lyanthec	Netherlands	Simpler Invoicing	Netherlands	XS Office AS	Norway
Cloud Trade Technology Ltd.	UK	Electronic Data Transfer S.A.S.	France	Maritech Systems AS	Norway	SINGAPORE E-BUSINESS PTE LTD	Singapore	Zirius AS	Norway
CodaBox N.V.	Belgium	Enable-U B.V.	Netherlands	Millum AS	Norway	Skaitos kompiuteriu servisas	Lithuania	ZZI d.o.o	Slovenia
Comarch SA	Poland	Enercom Swiss Finance SA	Switzerland	Ministry of Finance, Republic of Slovenia	Slovenia	Smartbook Technology AS	Norway		
Commerce-Connections	UK	Epoca S.r.l.	Italy	Ministry of Finance, Republic of Slovenia	Slovenia	Sorvive Technologies Inc.	USA		
Consorti Administració Oberta de Catalunya (AOC)	Spain	Esker S.A.	France	Miracle A/S	Denmark	STDM Srl	Italy		
Consumer Cloud Technology Services Pte Limited	Singapore	Eesti Post AS (Omniva)	Estonia	Moneybird	Netherlands	StarHub Ltd	Singapore		
		EVRY AS	Norway	mySupply ApS	Denmark	Storecove (Datajust B.V.)	Netherlands		
		Exact	Netherlands	NetClient AS	Norway	SYMTRAX S.A.	France		
		F.R. Biernat	Norway	NetEDI	UK	System Kreditt AS	Norway		
		Faber system Srl	Italy	Netropolix Software NV	Belgium	Svea Ekonomi AB	Sweden		
		FIKEN AS	Norway	Nets Norway AS	Norway	TB Okonomi AS	Norway		
		FinHill Hilversum B.V.	Netherlands	nexMart GmbH & Co. KG	Germany	Tecmarket Servizi S.p.A.	Italy		
		Financijska agencija	Croatia	Norwegian Labour and Welfare Service (NAV)	Norway	Teal IT	Belgium		
		Financijska agencija	Croatia						
		Fitek Group	Estonia						
		Fylkesmannen i Sogn og Fjordane	Norway						

eDelivery Access points in PEPPOL

Governance...

Characteristics from countries with high penetration of e-Invoicing

- Strong initiative from public sector
- Either a governmental authority or collaboration between several
- Provide policy/directions – standards and infrastructure
- Give support and provide capacity building
- Involvement in EU-level initiatives
- EMSFEI (High level and policy issues)
- OpenPEPPOL (Operational and practical issues)



Member state plans for the future



Denmark

Before 2019

eInvoice usage in public sector

98 %

Main syntax standard

ISO/IEC 19845:2015 UBL

Infrastructure

NemHandel

2019 →

Implementaion of the EN/CIUS

PEPPOL CIUS
(+Rules for domestic suppliers)

Plans for infrastructure

PEPPOL and NemHandel in parallel.
PEPPOL only long term.

Legislation (transposition of the directive)

eInvoicing already mandated for suppliers by law. Additional types for public entities will be affected.



Sweden

Before 2019

eInvoice usage in public sector

50% local/regional authorities
60% governmental authorities

Main syntax standard

ISO/IEC 19845:2015 UBL

Infrastructure

Various

2019 →

Implementaion of the EN/CIUS

PEPPOL CIUS
(+Rules for domestic suppliers)

Plans for infrastructure

PEPPOL

Legislation (transposition of the directive)

Law mandating suppliers to invoice electronically both above and below threshold.



Norway

Before 2019

eInvoice usage in public sector

70-80%

Main syntax standard

ISO/IEC 19845:2015 UBL

Infrastructure

PEPPOL

2019 →

Implementaion of the EN/CIUS

PEPPOL CIUS
(+Rules for domestic suppliers)

Plans for infrastructure

PEPPOL

Legislation (transposition of the directive)

Mandatory to require eInvoicing

Netherlands

Before 2019

eInvoice usage in public sector

Central government 50%
Regional/local 5%

Main syntax standard

ISO/IEC 19845:2015 UBL

Infrastructure

Central government - hub
The rest - PEPPOL

2019 →

Implementaion of the EN/CIUS

Country CIUS but will also accept
PEPPOL CIUS

Plans for infrastructure

PEPPOL

Legislation (transposition of the directive)

As is from the directive. Mandate
on the central government to
require eInvoicing in new contracts.



Austria

Before 2019

eInvoice usage in public sector

Federal government 50%
The rest - ?%

Main syntax standard

Domestic XML format
ISO/IEC 19845:2015 UBL

Infrastructure

Central service (webform+upload)
PEPPOL

2019 →

Implementaion of the EN/CIUS

Austrian CIUS on 2 levels. Country
specific rules and government
specific rules)
PEPPOL for cross boarder

Plans for infrastructure

Central service (webform+upload)
PEPPOL

Legislation (transposition of the directive)

As is from the directive



Cyprus

Before 2019

eInvoice usage in public sector

0%

Main syntax standard

-

Infrastructure

-

2019 →

Implementaion of the EN/CIUS

PEPPOL CIUS
(+Rules for domestic suppliers)

Plans for infrastructure

PEPPOL

Legislation (transposition of the directive)

As is from the directive

Croatia

Before 2019

eInvoice usage in public sector

Small number

Main syntax standard

ISO/IEC 19845:2015 UBL

Infrastructure

Centralized solution

2019 →

Implementaion of the EN/CIUS

PEPPOL CIUS
Domestic CIUS

Plans for infrastructure

PEPPOL + Connection to central
solution directly or through service
provider

Legislation (transposition of the directive)

Mandatory to send

Mentimeter

www.menti.com

Enter #69 50 89



What are

the CEF building blocks?

The CEF Building Blocks



eID

Extending the use of online services to citizens of other EU member states

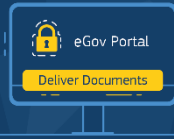

eDelivery

Supporting electronic registered delivery of data and documents



eSignature

Creating and verifying electronic signatures

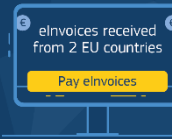

eInvoicing

Supporting Public Entities in the uptake of the EU Standard for eInvoicing

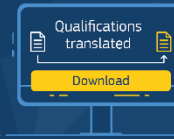

eTranslation

Exchanging information across languages in the EU Member States

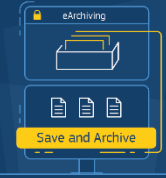

eArchiving

Tackling the challenge of short, medium and long-term data management and reuse

EU Login

EU Send

EU Sign
f.k.a. ESSI

Available
as-a-service to the
European Commission

Data Value Chain

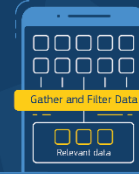

Context Broker

Managing and sharing real time data (context information) via a central hub



Big Data Test Infrastructure

Data and analytics services from infrastructure to tools for experimenting with Big Data technologies

The CEF Building Blocks are creating a common digital platform across Europe

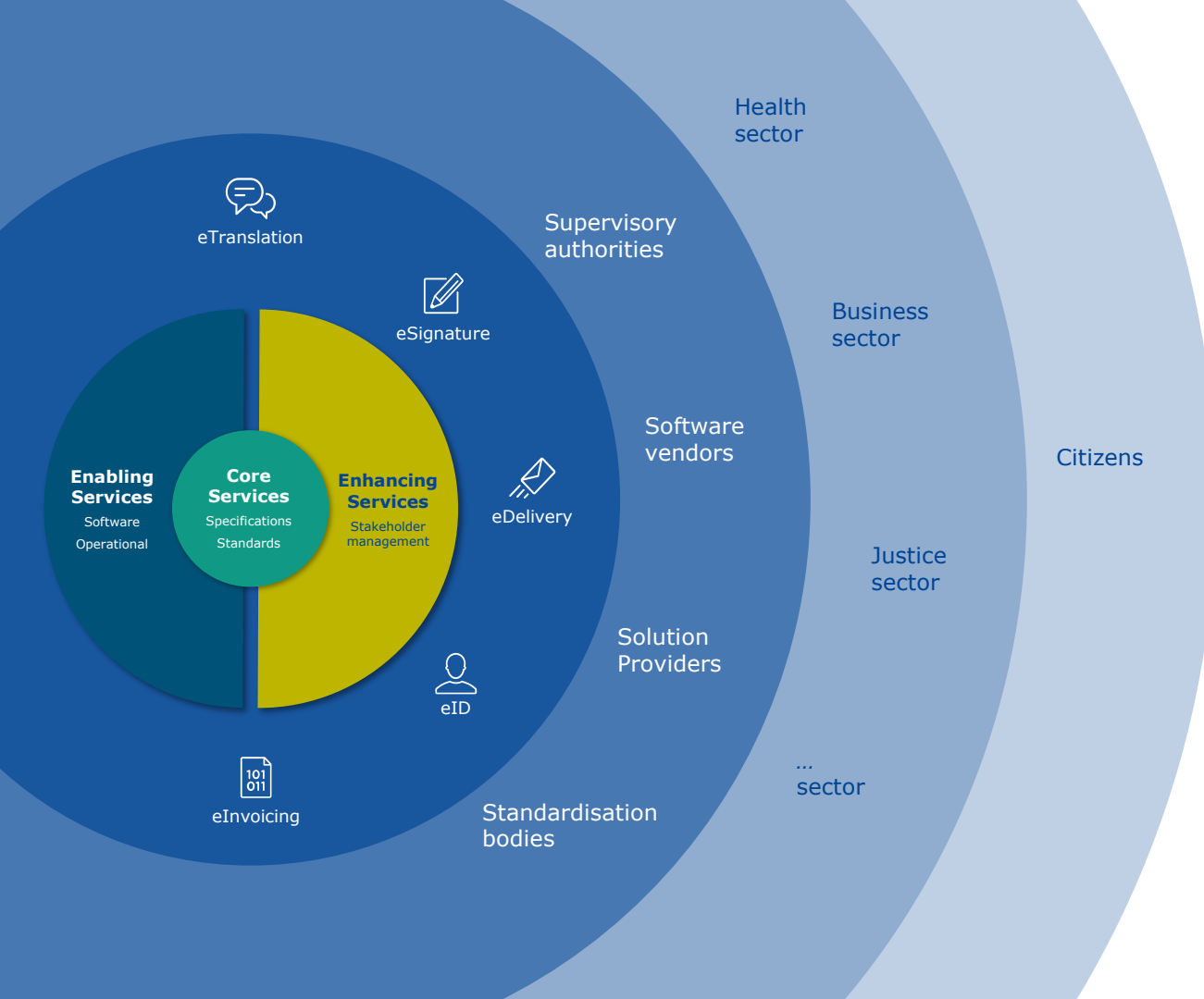

We are at the tipping point of the Connecting Europe Roadmap

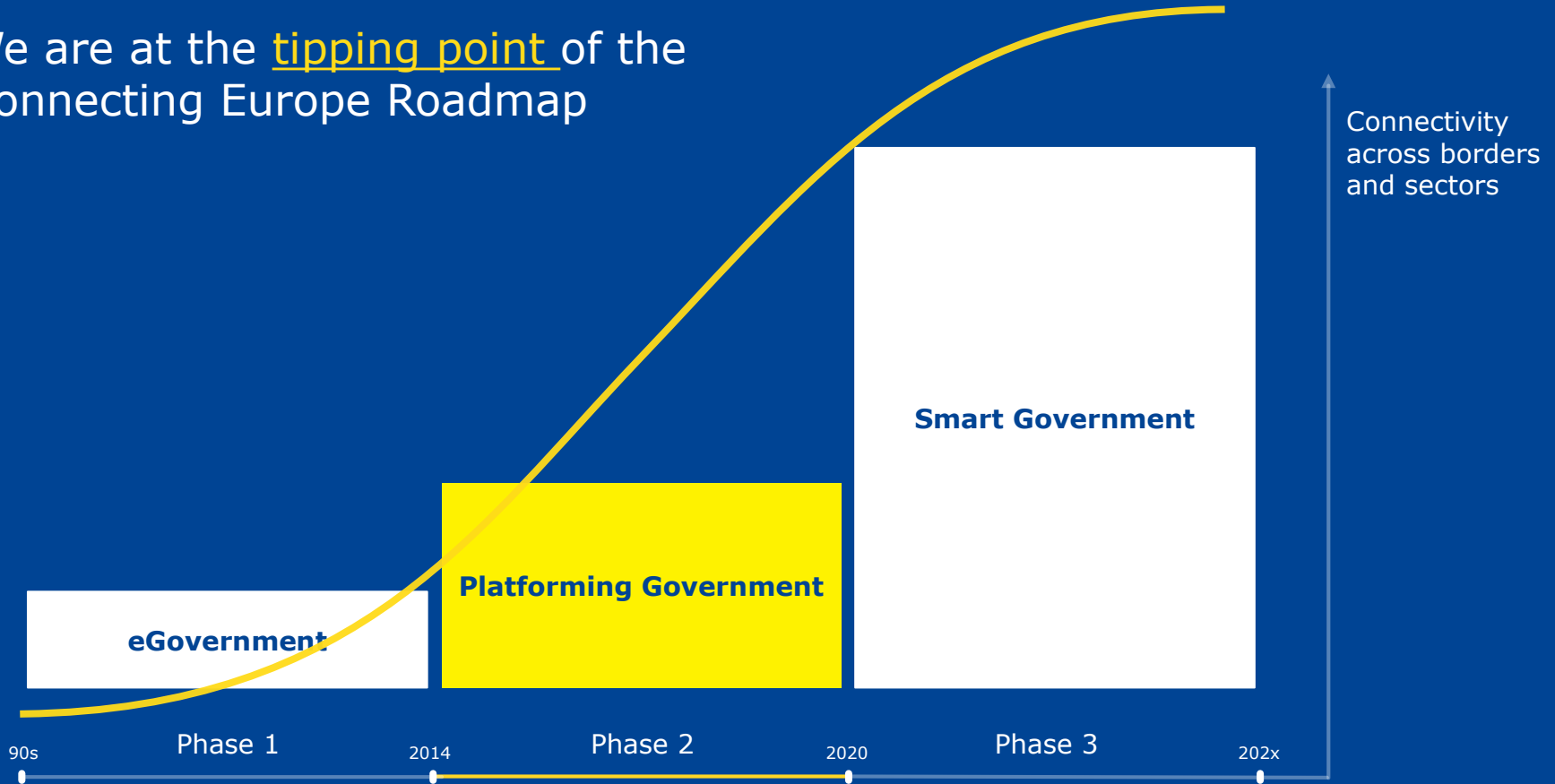

Phase 1: eGovernment.

However Europe cannot fully benefit from it because we are still working in silos, we still have digital borders....

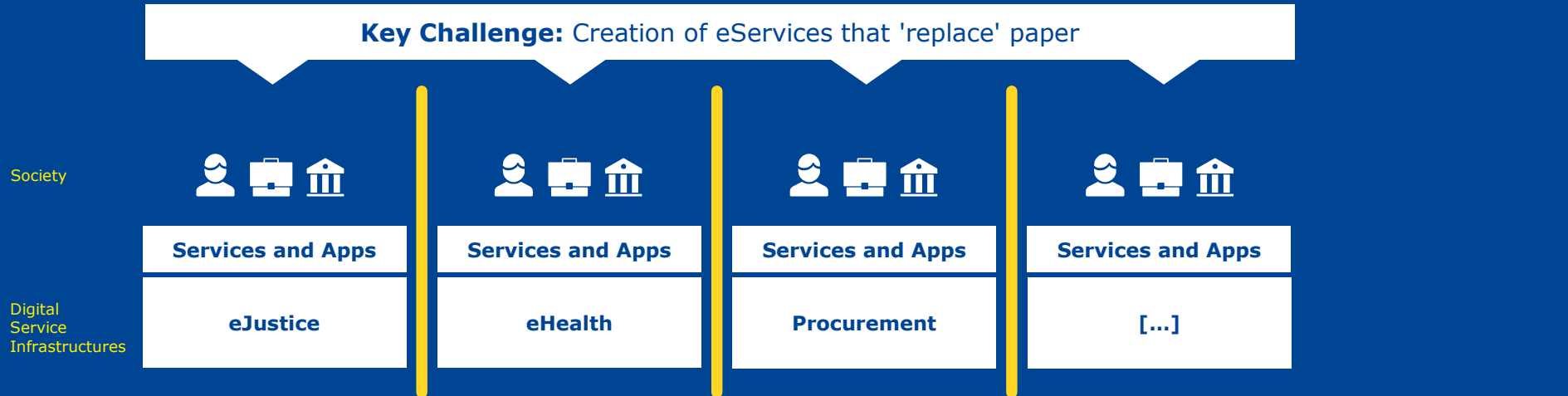

Phase 2: Platforming Government.

We need to remove digital barriers to create a fully functioning Digital Single Market.

Key Challenge: Connecting eServices across-borders and across-sectors

Society



Services and Apps

Services and Apps

Services and Apps

Services and Apps

Services and Apps

eJustice

eHealth

Procurement

Taxation

[...]

Digital Service Infrastructures

←..... Enabling Seamless Flow of Data→

Powered by the CEF Building Blocks



eID



eSignature



eDelivery



eInvoicing



eTranslation

CEF Building Blocks

Sectors are still being on boarded



Citizens



Businesses



Public Administrations

Phase 3: **Smart Government**. This is how we will ensure high quality, user-centric digital public services for citizens and seamless cross-border public services for businesses.

Key Challenge: Exploitation of the Digital Platform i.e. Once Only, Digital by Default, ...

Society



Services and Apps

Services and Apps

Services and Apps

Services and Apps

eJustice

eHealth

Procurement

Other Sectors

Digital Service Infrastructures

EIF Principles

← Enabling Seamless Flow of Data →



eID



eSignature



eDelivery



eInvoicing



eTranslation

CEF Building Blocks



Citizens



Businesses



Public Administrations



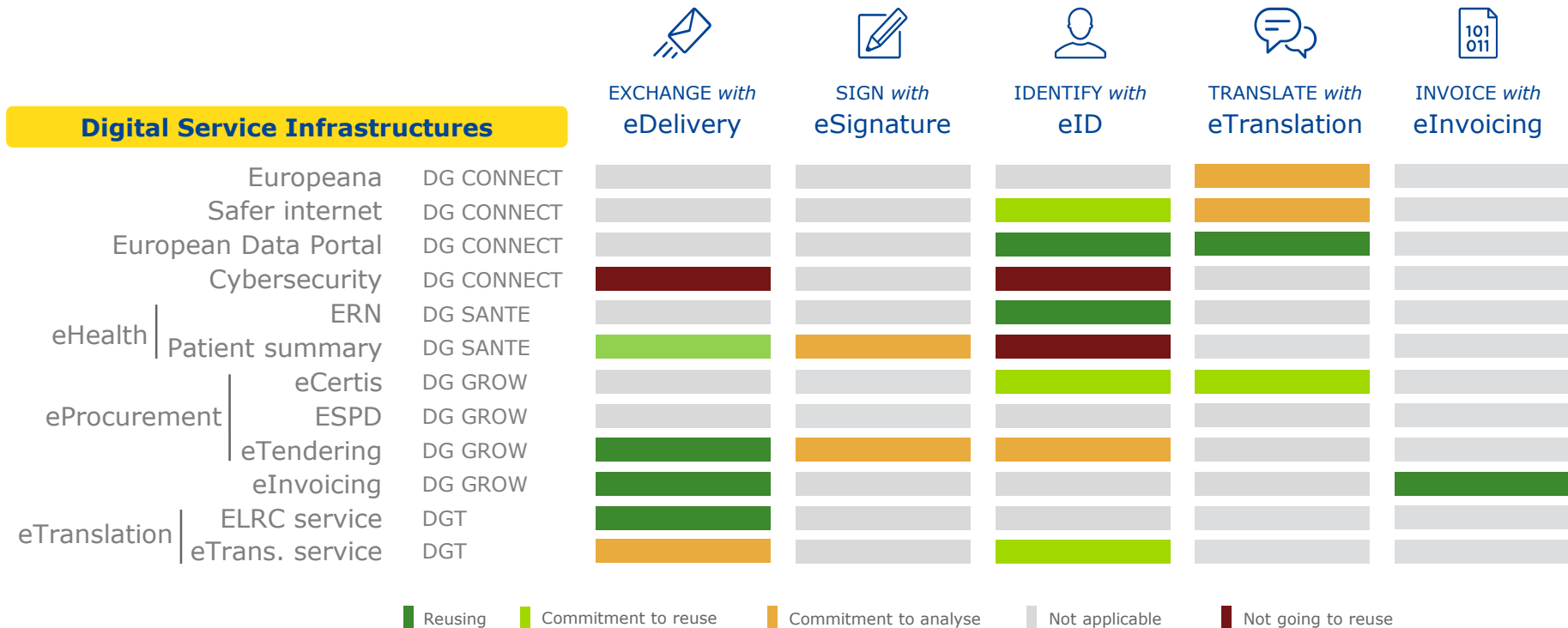

***Uptake of the
CEF building blocks***

Deployment in the CEF Digital Programme



■ Reusing
 ■ Commitment to reuse
 ■ Commitment to analyse
 ■ Not applicable
 ■ Not going to reuse

Deployment in the CEF Digital Programme

Digital Service Infrastructures		 EXCHANGE with eDelivery	 SIGN with eSignature	 IDENTIFY with eID	 TRANSLATE with eTranslation	 INVOICE with eInvoicing
e-Justice	e-Justice portal	DG JUST	Reusing	Reusing	Reusing	Not applicable
	E-evidence	DG JUST	Commitment to reuse	Commitment to reuse	Commitment to analyse	Not applicable
	IRI	DG JUST	Commitment to reuse	Not applicable	Not applicable	Not applicable
	Standard forms	DG JUST	Not applicable	Not applicable	Not applicable	Not applicable
	Me-CODEX	DG JUST	Reusing	Reusing	Not applicable	Not applicable
	e-Justice BRIS	DG JUST	Reusing	Commitment to analyse	Not applicable	Not going to reuse
	ODR	DG JUST	Reusing	Not going to reuse	Reusing	Not applicable
	ESSI	DG GROW	Reusing	Reusing	Reusing	Reusing
	P2P Mobile Payments	DG FISMA	Commitment to reuse	Commitment to analyse	Commitment to analyse	Commitment to analyse
eArchiving	DG CNECT	Commitment to analyse	Commitment to analyse	Commitment to analyse	Commitment to analyse	Not applicable

■ Reusing
 ■ Commitment to reuse
 ■ Commitment to analyse
 ■ Not applicable
 ■ Not going to reuse

Significant growth in the last year. Since November 2017...

Reuse

+ 128 %

41 more projects at the EC are **reusing** the CEF Building Blocks

32

EC projects reusing BBs



Nov. 2017

73

EC projects reusing BBs

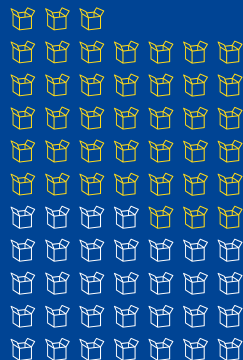

Nov. 2018

[Monitoring dashboard on CEF Digital](#)



Success Stories

+ 350%

21 more teams told us how they have successfully re-used the CEF Building Blocks

6

Success Stories



Nov. 2017

27

Success Stories

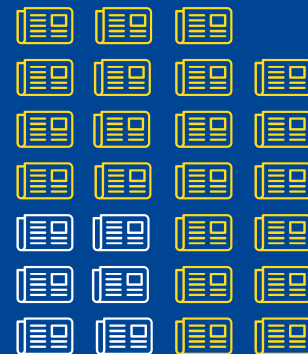

Nov. 2018

[View Success Stories on CEF Digital](#)

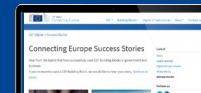

How does CEF support projects to use the building blocks?

In two ways:

- **One**, it provides services to help you implement them in your system. There are a range of services across the building blocks but services typically include training, sample software, testing services.

Free Services



Training sessions



Sample software



Testing services



Funding opportunities

Call	Open Calls	Deadline for submissions
CEF-TC-2019-1 Automated Translation (indicative budget: €4M)	14 February 2019	14 May 2019
CEF-TC-2019-1 eID & eSignature (indicative budget: €5M)	14 February 2019	14 May 2019
CEF-TC-2019-1 eDelivery (indicative budget: €1M)	14 February 2019	14 May 2019
CEF-TC-2019-1 eInvoicing (indicative budget: €6.2M)	14 February 2019	14 May 2019

How does CEF support projects to use the building blocks?

In two ways:

- **One**, it provides services to help you implement them in your system. There are a range of services across the building blocks but services typically include training, sample software, testing services.
- **Two**, CEF provides grant funding. You can apply for grant funding to pay for the implementation of a building block in you system. More information on how you can apply, grant winners and on-going projects is available via INEA's website.

[Visit INEA Website](#)

How many projects have used the building block?

118
projects

[View Dashboard](#)

Growing potential cases
are bringing us closer to
fulfilling the dream.

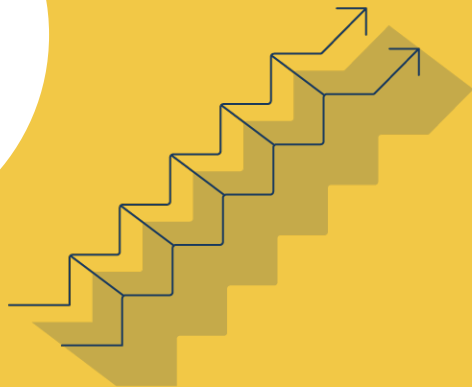

Connected Europe

Vision



**Great experience for
citizens and businesses**

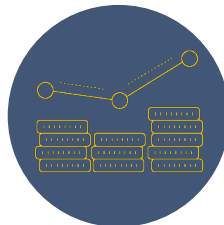

Building a data-economy

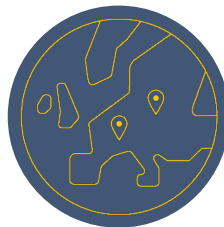

**Promoting cross-border
interoperability**

Main Benefits



1

The building blocks are mature, ready to deploy solutions that will save projects time and money.



2

The building blocks are based on open European standards so you avoid vendor lock-in.



3

They help public administrations connect to collaborate to deliver a great European experience for citizens and businesses.

How do we support you?

1

Apply for grant funding to pay for the implementation of a building block



2

The CEF Digital website has details of a range of services across to support your implementation



3

Our service desk is available for you to provide answers to any questions you may have



Join us, we're Connecting Europe!

The vision is to deliver user-centric digital public services for citizens and seamless cross-border public services for businesses.

Public administrations must exchange data securely across borders in order to collaborate effectively and deliver a great experience to citizens and businesses.

Projects using the building blocks are supporting the digital transformation of Europe by implementing eIDAS and contributing to the digital single market.



CEF Digital



CEF Digital
Connecting Europe

MENU COMMUNITY

[CEF Digital Home](#)

eInvoicing

Helping public entities adopt the European standard on electronic invoicing.

Learn about eInvoicing

Everything you need to know about eInvoicing +

Use eInvoicing

For public entities getting started with eInvoicing in public procurement +

Make your solution conformant

For solution & service providers looking to adopt the European standard on eInvoicing +

Join the community

Join one or more communities or help promote the uptake of eInvoicing +

Featured





Call for [grants](#) opens 28 June 2017

Communities

[eInvoicing User Community](#) 

[European Multi-Stakeholder Forum on eInvoicing](#) 

Quick Links

-  [Contact support](#)
-  [All eInvoicing Services](#)
-  [Readiness Checker](#)
-  [Monitoring dashboard](#)

Latest

[CEN Publishes eInvoicing Semantic Data Model](#)

The Innovation and Networks Executive Agency (INEA) launches grants of up to €10 million to support electronic invoicing (eInvoicing) in Europe.

CEF eInvoicing User Community

The screenshot shows a social media page for the 'eInvoicing User Community'. The top navigation bar includes 'Spaces', 'People', 'Polls', 'Calendars', 'Analytics', and 'Create'. The left sidebar contains navigation options like 'Analytics', 'SPACE SHORTCUTS', 'PAGE TREE', and 'Archive'. The main content area features a large banner for 'eINVOICING USER COMMUNITY' and a section titled 'THE EUROPEAN STANDARD' with a countdown timer showing '328 Days' and a 'Learn More' button. Below this is a 'FEATURED TWEETS' section with a blue banner for Portugal's public procurement code. The right sidebar includes 'About the community', 'Your space moderators' (with profile pictures), 'Contact us' (with a 'Contact' button), and a link to 'Read more about the eInvoicing Service Desk'. At the bottom right, there is a link for 'New Video & Infographic Now Available'.

UC eInvoicing User Community

Pages 1 JIRA link Analytics

CEf DIGITAL

eINVOICING USER COMMUNITY

THE EUROPEAN STANDARD

The European Parliament and Council adopted **Directive 2014/55/EU**, establishing the European standard. The recent publication of the European Standard on eInvoicing in the Official Journal of the European Union marks the beginning of the implementation phase of the standard.

The Directive mandates an 18-month implementation period after the publication of the standard, with **18 April 2019** fixed as the deadline for this.

3 2 8

Days

[Learn More](#)

FEATURED TWEETS

The Country Sheets for eInvoicing 2017 are here! Want to **learn more**? Simply click on the button below and **visit the Country Sheets!**

We kindly invite you to **spread the word!** By simply **retweeting** this message, together we create **more visibility** for the eInvoicing B2G status throughout Europe.

 Did you know that according to the Public Procurement Code, all public procurement processes in Portugal 🇵🇹 should preferably be performed electronically? More on #eInvoicing in Portugal: <http://europa.eu/!Gn73bt> #ConnectingEurope

About the community

The eInvoicing User Community space enables stakeholders involved and interested in cross-border eInvoicing, to discuss eInvoicing in the EU public and private sectors. The space is also used for co-creative activities with the Advisory Group and Early Adopters of the eInvoicing Readiness Checker Website, which is designed to help public administrations implement electronic invoicing, as per the requirements of Directive 2014/55/EU.

Your space moderators



Contact us

Get in touch with the CEF eInvoicing team for questions, comments or other type of requests.

[Contact](#)

Read more about the eInvoicing Service Desk

[New Video & Infographic Now Available](#)

Space tools

Stakeholder management services

Knowledge base

OBJECTIVE OF THE SERVICE

This service provides public entities and solution & service providers an easy reference repository for eInvoicing related information.

It includes information about access to the different code lists, codes used and their meaning, and a glossary of elements used in the European eInvoicing standard.

The Knowledge base provides information on EU and country specific levels.

BENEFITS

- This service provides a useful and reliable information repository that helps users to find, consult and interpret information resources about eInvoicing in Europe.
- It provides useful information that public administrations can use to plan, initiate and execute eInvoicing implementation plans and strategies.

The screenshot shows a news article on the CEF Digital website. At the top left is the CEF Digital logo with the text 'Connecting Europe'. Below the logo is a search bar. The article title is 'CEF eInvoicing Video and Infographic: Available Now'. The main image is an infographic titled 'Directive 2014/55/EU' showing three computer monitors with checkmarks and a central monitor with a document icon. Below the infographic is a stylized cityscape with labels for 'REGIONAL', 'CENTRAL GOVERNMENT', and 'LOCAL GOVERNMENT'.

USERS

Public entities

Policy makers

Economic operators & suppliers

Solution & service providers

More info

[CEF Digital](#) >

Get started

[Contact us](#) >

2018 Country Factsheets



CEF Digital
Connecting Europe

MENU COMMUNITY

[CEF Digital Home](#) > [eInvoicing](#)

Situation per country

Interested in the uptake of eInvoicing in Europe?

[CEF Monitoring Dashboard >](#)

Every European Union Member State has a unique approach to dealing with eInvoicing. For each country you can find out more about their:

- policy framework
- eInvoicing platform (if existing)
- approach for receiving and processing electronic invoices

Summary

Organisation responsible for eInvoicing	
eInvoicing legislation	
eInvoicing is mandatory for	
eInvoicing standard(s)	
eInvoicing platform	

Full Country Factsheet

Legislation

..

eInvoicing platform and eInvoicing management solutions

..

Approach for receiving and processing eInvoices

..

Additional information

..

Country factsheets

EU Member States

Austria	Italy
Belgium	Latvia
Bulgaria	Lithuania
Croatia	Luxembourg
Cyprus	Malta
Czech Republic	The Netherlands
Denmark	Poland
Estonia	Portugal
Finland	Romania
France	Slovakia
Germany	Slovenia
Greece	Spain
Hungary	Sweden
Ireland	United Kingdom
ADDITIONAL EEA (European Economic Area) COUNTRIES	
Iceland	Norway
Liechtenstein	



Read all the Connecting Europe success stories on CEF Digital

[View >](#)

Ready to get started?

Reach out to us to learn more!

Or visit our website www.ec.europa.eu/cefdigital

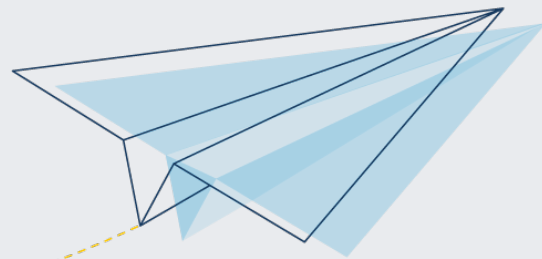

Funding and Grants – possibilities within CEF



Funding opportunities

Call	Open Calls	Deadline for submissions
CEF-TC-2019-1 Automated Translation (indicative budget: €4M)	14 February 2019	14 May 2019
CEF-TC-2019-1 eID & eSignature (indicative budget: €5M)	14 February 2019	14 May 2019
CEF-TC-2019-1 eDelivery (indicative budget: €1M)	14 February 2019	14 May 2019
CEF-TC-2019-1 eInvoicing (indicative budget: €6.2M)	14 February 2019	14 May 2019

Visit INEA Website

Member States Number of projects and CEF funding (€ thousand)

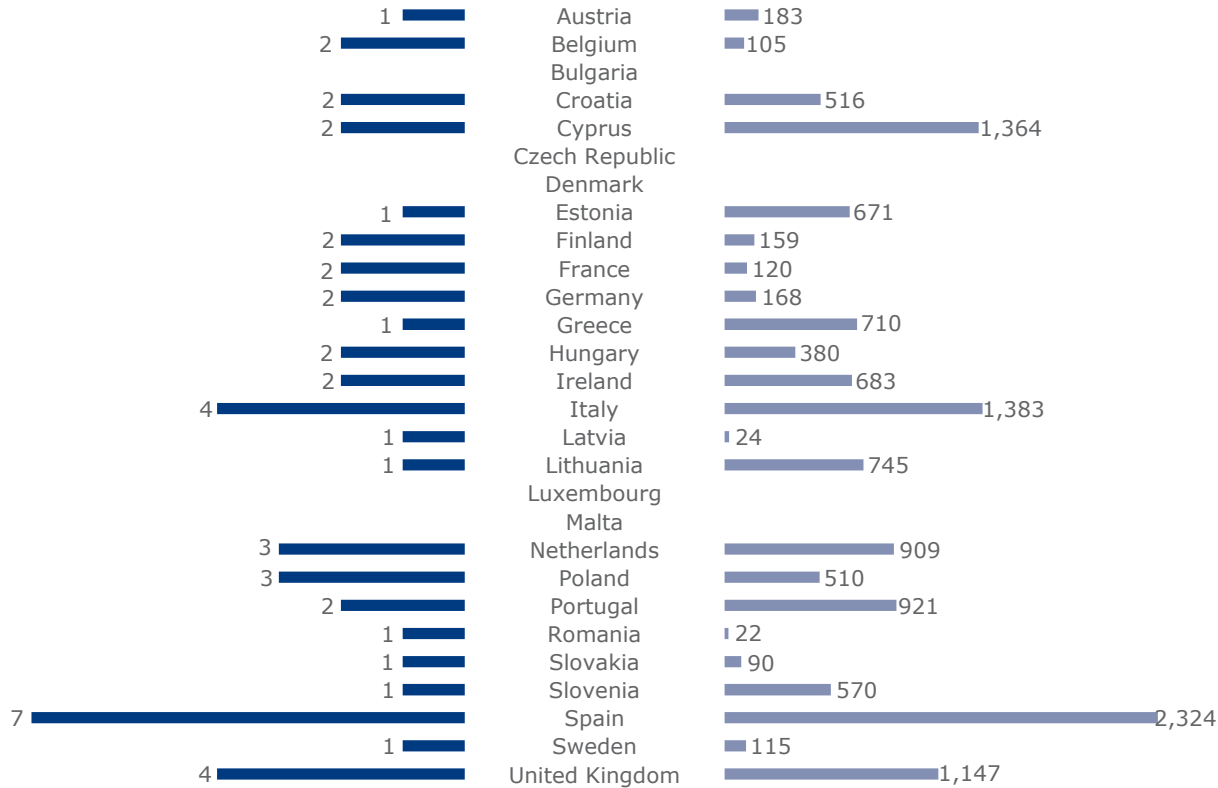

EEA and Third Countries Number of projects and CEF funding (€ thousand)

1 Norway 714

CEF Telecom 2014-2016

List of grant agreements for eInvoicing DSI building blocks

Project Code	Title	Beneficiary countries	Start Date	End Date	Project Status	CEF funding for the action (€)
2015-AT-IA-0049	EVA - e-Invoicing for Austria	AT	01/09/2016	31/12/2017	Ongoing	183,000
2015-CY-IA-0052	E-invoicing Cyprus	CY	01/10/2016	31/12/2017	Ongoing	561,430
2015-ES-IA-0055	SMART eINVOICING PLATFORM TO ENFORCE CROSS-BORDER DOCUMENTATION EXCHANGE (SEINPEX)	ES	01/08/2016	31/12/2017	Ongoing	222,781
2015-EU-IA-0050	eIGOR - eInvoicing GO Regional	IT,UK	01/01/2017	31/12/2017	Ongoing	1,252,500
2015-EU-IA-0054	Semantic conversion of business documents (SCOBDO)	DE,NL	01/09/2016	31/12/2017	Ongoing	283,199
2015-EU-IA-0058	GOVeIn European eInvoicing Project: implementation of the European electronic invoice within the Public Health area	ES,FR,HU,IE,IT,NL,PL,RO,UK	01/10/2016	31/10/2017	Ongoing	770,249
2015-HR-IA-0048	Croatian eInvoicing Business-to-Administration Exchange Project	HR	02/06/2016	30/05/2017	Closed	251,328
2015-UK-IA-0056	eInvoice Expansion	UK	01/10/2016	31/12/2017	Ongoing	901,624
2016-CY-IA-0105	Cy e-Invoicing (Local Authorities)	CY	01/01/2018	31/12/2018	Ongoing	802,134
2016-EL-IA-0130	Interoperable eInvoicing in Greece (GRinv)	EL	01/10/2017	30/09/2018	Ongoing	710,065
2016-ES-IA-0117	FACe - The core platform of the Spanish public authorities to process the European standard on electronic invoice	ES	01/09/2017	30/11/2018	Ongoing	298,691
2016-ES-IA-0134	EUeInvoicing.cat - European standards adoption for eInvoicing in Catalonia	ES	01/09/2017	31/08/2018	Ongoing	622,833
2016-EU-IA-0086	Tools and support towards the adoption of the future EN on electronic invoicing in SMEs	BE,ES,IT	01/09/2017	31/08/2018	Ongoing	372,054
2016-EU-IA-0096	GOV2EU - Supporting public entities to adopt EU Standard on electronic invoice for cross-border transactions	BE,DE,ES,FR,HU,IT,PL,PT,SK	01/09/2017	31/10/2018	Ongoing	1,248,208
2016-EU-IA-0109	SAPHeIN – Implementing SAPHetydoc for the wide adoption of eInvoicing	ES,PT	01/06/2017	31/08/2018	Ongoing	908,837
2016-EU-IA-0119	Facilitate and increase the use of the European Norm on e-invoice and the use of access point in the EU	FI,NO,SE	15/12/2016	01/06/2018	Ongoing	887,879
2016-EU-IA-0120	Internet of Business (IoB)	EE,FI,LV	01/06/2017	31/05/2018	Ongoing	795,248
2016-EU-IA-0126	Promote uptake of e-invoicing in Ireland	IE,UK	01/07/2017	30/06/2018	Ongoing	755,904
2016-HR-IA-0090	eINVOICING For Croatian Public Authorities (eICPA)	HR	19/09/2017	19/09/2018	Ongoing	264,201
2016-LT-IA-0104	eInvoicing cross-border LT	LT	01/09/2017	01/09/2018	Ongoing	744,553
2016-NL-IA-0088	NL eInvoicing	NL	16/12/2016	31/05/2018	Ongoing	705,068
2016-PL-IA-0106	European cross-border e-invoice in local public procurement in Poland	PL	01/10/2017	30/11/2018	Ongoing	420,442
2016-SI-IA-0103	Readiness of Slovenian E-invoicing	SI	01/06/2017	01/06/2018	Ongoing	570,248

Mentimeter

www.menti.com

Enter #69 50 89



Curious to learn more?!

Contact info

- CEF-BUILDING-BLOCKS@ec.europa.eu

Planning for 2019

- Several workshops in planning

Meanwhile – take a look at the available material on CEF Digital

- <https://ec.europa.eu/cefdigital/wiki/display/CEFDIGITAL/eInvoicing>



Lessons learned

QUESTIONS?