

Analysis of Electricity Network Capacities and Identification of Congestion

Final Report

Aachen, December 2001

commissioned by the

European Commission

Directorate-General Energy and Transport

carried out by the

Institute of Power Systems and Power Economics (IAEW)

of Aachen University of Technology (RWTH Aachen)

Schinkelstr. 6, D-52056 Aachen, Tel. +49. 241. 8097652, Fax +49. 241. 8092197

e-mail: haubrich@iaew.rwth-aachen.de

and

CONSENTEC Consulting für Energiewirtschaft und -technik GmbH

Krantzstr. 7, D-52070 Aachen, Tel. +49. 241. 93836-0, Fax +49. 241. 93836-15

e-mail: info@consentec.de

Analysis of Electricity Network Capacities and Identification of Congestion

Final Report

Aachen, December 2001

commissioned by the

European Commission

Directorate-General Energy and Transport

carried out by

Univ.-Prof. Dr.-Ing. **Hans-Jürgen Haubrich**, Dr.-Ing. **Christian Zimmer**,

Dipl.-Ing. **Klaus von Sengbusch**, M.Sc. **Feng Li**

Institute of Power Systems and Power Economics (IAEW)

of Aachen University of Technology (RWTH Aachen)

Schinkelstr. 6, D-52056 Aachen, Tel. +49. 241. 8097652, Fax +49. 241. 8092197

e-mail: haubrich@iaew.rwth-aachen.de

and

Dr.-Ing. **Wolfgang Fritz**, Dipl.-Ing. **Stefanie Kopp**

CONSENTEC Consulting für Energiewirtschaft und -technik GmbH

Krantzstr. 7, D-52070 Aachen, Tel. +49. 241. 93836-0, Fax +49. 241. 93836-15

e-mail: info@consentec.de

with a sub-task contributed by

Prof. Dr. **Walter Schulz**, Dipl.-Volksw. **Felix Müsgens**, Dipl.-Volksw. **Markus Peek**

Institute of Energy Economics (EWI) at the University of Cologne

Albert-Magnus-Platz, D-50923 Köln, Tel. +49. 221. 4702258, Fax +49. 221. 446537

Table of Contents

Abbreviations	vii
Executive Summary	I
1 Introduction and objective	1
2 Methodical approach	5
2.1 Phase 1: Capacity determination methods and transmission bottlenecks	5
2.2 Phase 2: Demand and possibilities to increase transmission capacity	7
3 Determination and allocation of cross-border transmission capacity	9
3.1 Overview	9
3.2 Determination of indicative NTC values published by ETSO	10
3.2.1 Data base and methodology	10
3.2.2 Assessment of network security	17
3.2.3 Limits of feasible network operation	19
3.2.4 Consideration of uncertainties	25
3.3 Differences between indicative NTC and allocable capacities	29
3.4 Conclusions	31
4 Identification of critical bottlenecks	32
5 Investigations on the demand for transmission capacity	34
5.1 Introduction	34
5.2 Investigations carried out by TSOs	36
5.3 Investigation for France-Italy based on a generation dispatch model	37
5.3.1 Objective	37
5.3.2 Methodology	38
5.3.3 Results for the base scenario	40
5.3.4 Results of the sensitivity analysis	44
5.3.5 Summary	46
5.4 Considerations for France-Spain based on dispatch information	47
5.5 Evaluation of transmission capacity auctioning results	51
5.6 Evaluation of publicly available energy forecasts	56
5.7 Determination of network density	57
5.8 Conclusions	61

6	General considerations on “soft measures” to increase transmission capacity	63
6.1	Principles of capacity determination and allocation	63
6.1.1	General remarks on the applicability of NTC values	63
6.1.2	Co-ordinated capacity allocation	64
6.1.3	Cross-border congestion management	68
6.1.4	Probabilistic evaluation of operational uncertainties	69
6.1.5	Transparency and harmonisation	72
6.2	Extension of operational limits	73
6.2.1	Assumptions on environmental conditions	73
6.2.2	Temporary overload and corrective measures	77
6.2.3	Neglecting rare failures	78
6.3	Costs of soft measures	80
6.4	Legal issues	80
6.5	Conclusions	81
7	General considerations on network reinforcement measures	82
7.1	Overview on possible reinforcement measures	82
7.2	Economic assessment	84
7.2.1	Cost determination	84
7.2.2	Evaluation criteria	87
7.3	Feasibility issues	87
7.4	TEN projects of common interest	88
8	Evaluation of measures to increase individual cross-border capacities	89
8.1	Overview	89
8.2	Significance of load flow based investigations as evaluation criterion	89
8.3	France/Switzerland/Austria(/Slovenia) → Italy	90
8.3.1	Soft measures	90
8.3.2	Network reinforcement	92
8.3.3	Evaluation	95
8.4	Germany ↔ Denmark	96
8.4.1	Soft measures	96
8.4.2	Network reinforcement	98
8.4.3	Evaluation	99
8.5	Belgium/Germany → Netherlands & France → Belgium	100

8.5.1	Soft measures	100
8.5.2	Network reinforcement	104
8.5.3	Evaluation	107
8.6	France → Spain	108
8.6.1	Soft measures	108
8.6.2	Network reinforcement	109
8.6.3	Evaluation	112
8.7	Norway ↔ Sweden	112
8.7.1	Soft measures	113
8.7.2	Network reinforcement	113
8.7.3	Evaluation	115
9	Conclusions	117
9.1	Observations	117
9.2	General recommendations	118
9.3	Recommendations for individual borders	123
9.3.1	France/Switzerland/Austria/(Slovenia) → Italy	123
9.3.2	France → Spain	124
9.3.3	Belgium/Germany → Netherlands & France → Belgium	124
9.3.4	Germany ↔ Denmark	125
9.3.5	Norway ↔ Sweden	126
10	References	127
	Appendix	A-1
A	Meetings held in the course of this study	A-1
B	Electricity transmission and network access	B-1
B.1	Interconnected power systems in Europe	B-1
B.2	Technical aspects of interconnected transmission systems	B-5
B.2.1	Power balancing	B-5
B.2.2	AC transmission	B-5
B.2.3	DC transmission	B-7
B.2.4	Network security requirements	B-8
B.3	Access to transmission systems	B-9
B.3.1	Basic principles	B-9
B.3.2	Definitions of transmission capacity	B-13

B.3.3	NTC Assessment	B-14
C	Present state of cross-border access to transmission networks	C-1
C.1	General country-related information on transmission access	C-1
C.1.1	Key figures on electricity supply	C-1
C.1.2	Status of electricity market opening	C-2
C.2	Regulators, TSOs, network access and market organisation	C-2
C.3	Cross-border connections of the European transmission systems	C-10
D	Additional information on the determination and allocation of cross-border transmission capacity	D-1
D.1	Determination of indicative NTC values published by ETSO	D-1
D.1.1	Data base and methodology	D-1
D.1.2	Assessment of network security	D-3
D.1.3	Limits of feasible network operation	D-4
D.1.4	Determination of TRM	D-7
D.1.5	Summary of NTC determination principles	D-8
D.2	Methods for allocation of cross-border capacity and determination of allocable capacity	D-12
D.2.1	Portugal ↔ Spain	D-12
D.2.2	France ↔ Spain	D-13
D.2.3	France ↔ Great Britain	D-14
D.2.4	France ↔ Belgium	D-14
D.2.5	France ↔ Germany	D-15
D.2.6	Netherlands ↔ Belgium/Germany	D-15
D.2.7	Germany ↔ Denmark	D-16
D.2.8	Germany ↔ Sweden	D-16
D.2.9	France/Switzerland/Austria ↔ Italy	D-17
D.2.10	Borders inside the NORDEL interconnection	D-18
E	Individual analysis of cross-border transmission congestion	E-1
E.1	Overview	E-1
E.2	Portugal ↔ Spain	E-1
E.3	France ↔ Spain	E-3
E.4	France ↔ Great Britain	E-5
E.5	France ↔ Belgium	E-6

E.6	France ↔ Germany	E-7
E.7	Netherlands ↔ Belgium/Germany	E-8
E.8	Germany ↔ Denmark	E-12
E.9	Germany ↔ Sweden	E-16
E.10	France/Switzerland/Austria(/Slovenia) ↔ Italy	E-16
E.11	Austria ↔ Switzerland	E-19
E.12	Austria ↔ Germany	E-19
E.13	Finland ↔ Sweden	E-21
E.14	Norway ↔ Sweden	E-21
F	Details on investigations regarding transmission capacity demand	F-1
F.1	Details on the model-based investigation for France-Italy	F-1
F.1.1	The model EUDIS	F-1
F.1.2	Parameterisation	F-5
F.1.3	Simulation results	F-7
F.2	Details on the evaluation of publicly available energy forecasts	F-12
F.2.1	Introduction	F-12
F.2.2	Forecast documents	F-13
F.2.3	Results	F-19
G	Probabilistic approach to derive assumptions for ambient temperatures	G-1
G.1	Variation with respect to time of year and time of day	G-1
G.2	Relation between probability of excessive temperature and resulting temperature assumptions	G-3
H	Assumptions on investment and maintenance costs	H-1
I	Load flow based investigations	I-1
I.1	Overview and data base	I-1
I.2	Determination of network density	I-1
I.2.1	Algorithm	I-1
I.2.2	Results	I-3
I.3	Measures to increase transmission capacity	I-5
I.3.1	Methodology	I-5
I.3.2	France/Switzerland/Austria(/Slovenia) → Italy	I-8
I.3.3	Germany → Netherlands & France → Belgium/Netherlands	I-14

I.3.4	France → Spain	I-19
J	Questionnaire on NTC Assessment and Congestion	J-1
J.1	NTC Assessment	J-1
J.1.1	TTC Assessment	J-1
J.1.2	TRM assessment	J-5
J.2	Congestions	J-6
K	Questionnaire on measures to increase transmission capacity	K-1
K.1	Purpose of this questionnaire	K-1
K.2	Operational Measures	K-1
K.2.1	Variation of ambient temperature	K-1
K.2.2	Other operational measures	K-3
K.3	Network reinforcements	K-3
K.3.1	Planned network reinforcements	K-3
K.3.2	Evaluation of network reinforcements	K-5

Abbreviations

Country codes

A	Austria	GR	Greece
B	Belgium	I	Italy
CH	Switzerland	IRL	Ireland
D	Germany	L	Luxembourg
DK	Denmark	N	Norway
E	Spain	NL	The Netherlands
F	France	P	Portugal
FIN	Finland	S	Sweden
GB	Great Britain		

Other abbreviations

AC	Alternating current
ATSOI	Association of Transmission System Operators of Ireland
BCE	Base case exchange
CCGT	Combined Cycle Gas Turbine
CHP	Combined Heat and Power
CENTREL	Association of transmission system operators of Czechia, Hungary, Poland, and Slovakia
DACF	Day ahead congestion forecast
DC	Direct current
DVG	Deutsche Verbundgesellschaft (Association of German TSOs)
ETSO	European Transmission System Operators Association
FACTS	Flexible AC transmission systems
NORDEL	Organisation för nordiskt elsamarbete (Association of Nordic TSOs)
NTC	Net Transfer Capacity
NTPA	Negotiated third party access

OCGT	Open Cycle Gas Turbine
RES	Renewable Energy Sources
RTPA	Regulated third party access
SB	Single buyer
SMC	System marginal cost
SPS	Special protection system
TRM	Transmission Reliability Margin
TSO	Transmission System Operator
TTC	Total Transfer Capacity
UCTE	Union pour la Coordination du Transport de l'Électricité
UKTSOA	United Kingdom Transmission System Operators Association

Appendix

A Meetings held in the course of this study

During the execution of this study, communication with all concerned TSOs and regulators as well as other organisations (traders, consumers, associations) has taken place by means of ordinary mail, e-mail or telephone. In addition, the following meetings with the orderer and the other concerned parties have been held in order to obtain the necessary information and arguments for a comprehensive discussion of the study subjects.

Date	Place	Participants (Company/Association/Authority)
5 Feb. 2001	Brussels	DG TREN
19 Feb. 2001	Brauweiler	RWE Net (German TSO)
2 Mar 2001	Aachen	ATEL (Swiss TSO)
15 March 2001	Brauweiler	DVG (German TSOs' association) and members
3 April 2001	Vienna	Verbund APG (Austrian TSO)
3 April 2001	Innsbruck	TIWAG (Austrian TSO)
4 April 2001	Frankfurt	Enron (power trader)
10 April 2001	Frankfurt	DVG and members
25 April 2001	Stockholm	Svenska Kraftnät (Swedish TSO)
17 May 2001	Paris	RTE (French TSO)
18 May 2001	Brussels	EURELECTRIC working group
5 June 2001	Aachen	Pechiney (industrial consumer)
27 June 2001	Brussels	DG TREN
28 June 2001	Frankfurt	VIK Committee
27 July 2001	Lisbon	ERSE (Portuguese regulatory authority)
28 Aug 2001	Arnhem	TenneT (Dutch TSO)
3 Sep 2001	Zurich	Swiss TSOs and ETRANS
6 Sep 2001	Brussels	DG TREN
11 Sep 2001	Paris	RTE
17 Sep 2001	Fredericia	Eltra (Danish TSO)
20 Sep 2001	Brauweiler	DVG and members
21 Sep 2001	Rome	GRTN (Italian TSO)
24 Sep 2001	Stockholm	Svenska Kraftnät
25 Sep 2001	Milan	Edison (power generator, trader and transmission network owner)
25 Sep 2001	Milan	Autorità per l'energia elettrica e il gas (Italian regulatory authority)
26 Sep 2001	Brussels	ELIA (Belgian TSO)
4 Oct 2001	Madrid	REE (Spanish TSO)
10 Oct 2001	Oslo	Statnett (Norwegian TSO)

B Electricity transmission and network access

B.1 Interconnected power systems in Europe

The system of electrical power supply comprises elements:

- for procuring primary energy sources and for generating electricity in different types of power plants,
- for long-distance transmission of electricity from large power plants, which represent the dominant part of generation today and in the future, to major customers and load centres,
- for distribution of required amounts of electricity to the consumers on a regional and local level, and finally
- for conversion of electricity into the appropriate energy form needed by customers, i.e. final consumption (fig. B.1).

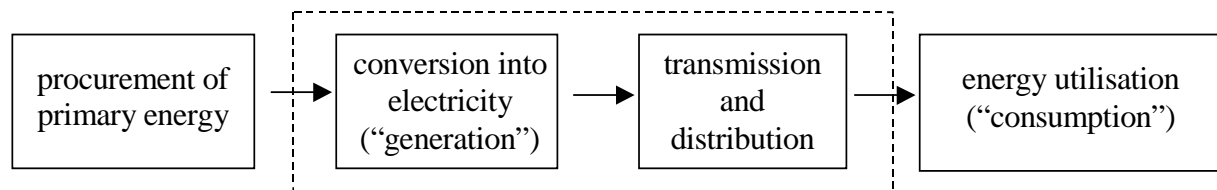

Fig. B.1: Subsystems of electrical power supply

In its narrowest sense, electrical power supply is defined as the subsystems of generation, and transmission and distribution networks, as shown in the dotted box in fig. B.1. Both subsystems comprise several components of different technologies and largely different capacities:

- The power generation sector
consists of generation units with capacities varying from kilowatts (kW) to gigawatts (GW = million kW), mainly using water, natural gas and oil, brown and hard coal and nuclear fuel as primary energy sources.
- The power transmission and distribution sector
consists of networks at different voltage levels which are vertically connected via transformers.

In Europe, the electricity networks are basically composed of four groups of voltage levels (fig. B.2):

- extra high voltage (EHV): 380 kV (standard in UCTE and GB),
400 kV (standard in NORDEL) and
220 kV ... 300 kV (non standard)
- high voltage (HV): 60 kV ... 150 kV
- medium voltage (MV): 10 ... 50 kV
- low voltage (LV): 0.23 / 0.4 kV

Often there exist networks of more than one voltage level within the above groups. Only low voltage is generally defined at one standardised voltage level of 0.4 kV. The EHV networks are, with the exception of few lines that clearly serve distribution purposes, defined as transmission networks. In some countries, a part of the HV and sometimes even MV networks are also regarded transmission networks. The separation between transmission and distribution is therefore not derived from the definition of voltage levels, but from the function of the networks. Since parts of the network serve both transmission and distribution purposes, this separation is not made uniformly.

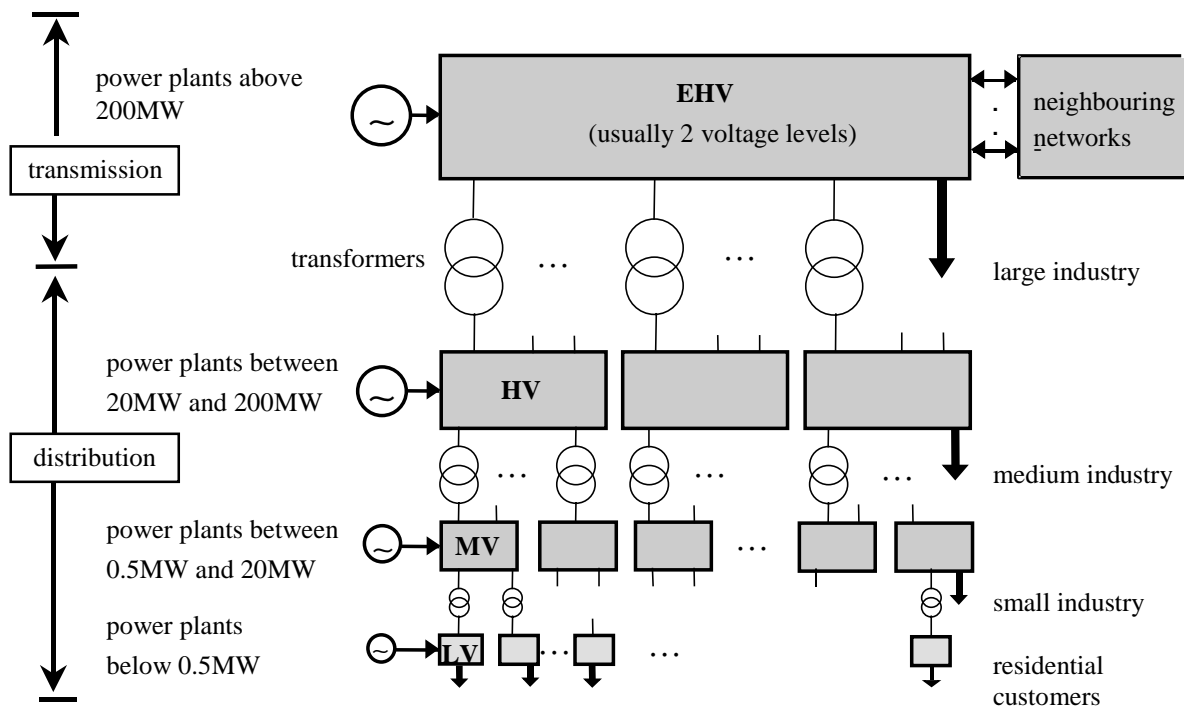

Fig. B.2: Typical network structure in European countries (MW limits for power plants are approximate values)

Power plants and consumers are connected to the different voltage levels depending upon their generation capacity or demand.

Development of national and international network infrastructure has evolved over a lengthy period. As a result of the rapid growth in electricity demand and the necessity for each national economy to meet demand in a secure way, and at minimal cost, many small local supply "islands" that were established at the beginning of the 20th century were only totally interconnected in the fifties, thus forming nationally connected systems.

The development of the 380 kV technology and the political integration of Western Europe have facilitated the development of the West European interconnection system, envisaged since 1930, during the second half of the 20th century. Today, 18 countries in continental Europe, or more precisely the Transmission System Operators (TSOs) of these countries, have connected their EHV networks synchronously, i.e. by alternating current (AC) lines thus enforcing operation at equal frequency. This includes the members of the UCTE interconnection ("Union pour la Coordination du Transport de l'Electricité"; before July 1999 named UCPTE = "...de la Production et du Transport...") plus the continental part of Denmark (fig. B.3). More recently, this interconnection has been extended to Northern Africa.

Similar interconnected transmission networks have been established in Ireland, Great Britain and Scandinavia, represented by the regional organisations ATSOI (Association of TSOs in Ireland), UKTSOA (United Kingdom Transmission System Operators Association) and NORDEL (Organisation for Nordic Electric Power Co-operation).

The aforementioned four interconnected systems are not synchronously coupled to each other so far, mainly as a consequence of the geographical separation. Between the systems of NORDEL, UCTE and UKTSOA, there exist however a number of direct current (DC) connections that facilitate power transmission between these systems, too.

The main benefits of operating large interconnected power systems are:

- load profiles of large groups of consumers are much smoother than those of single consumers,
- nation-wide and even international access to local deposits of primary energy sources that are impossible or expensive to transport (e.g. water, brown coal), and to generation capacity that is temporarily available in the short term,
- economy of scale as a result of large generation and transmission capacities (which are sometimes operated collectively by several owners),
- aggregating the reserve demand to improve quality of supply (particularly reliability), by mutually exchanging reserve power when faults or forecast errors occur.

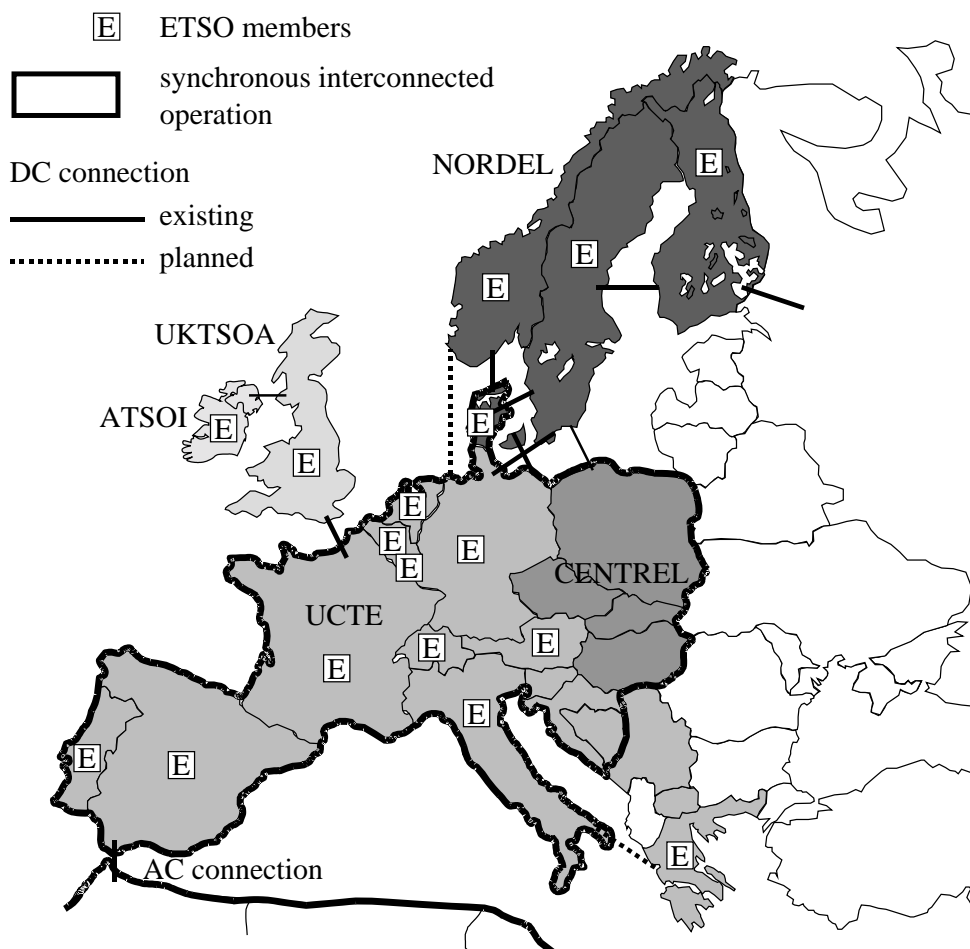

Fig. B.3: Western and Northern European interconnected systems (Note: Since mid-2001, CENTREL countries are full members of UCTE)

In addition, the interconnection of transmission networks has given rise to electricity trading among the interconnected utilities long before market liberalisation, e.g. to facilitate access to the cheapest sources of electricity at all times, or to substitute own generation capacity by long-term electricity purchase contracts with other utilities.

Upon the emergence of the Internal Electricity Market in the European Union, the above-mentioned regional TSO organisations as well as the member states, their regulatory authorities and the European Commission recognised the need for an EU-wide harmonisation of network access and conditions for usage, especially for cross-border electricity trade. In 1999, the Association of European Transmission System Operators (ETSO) was created by ATSOI, UKTSOA, NORDEL and UCTE as founding associations. The countries covered by these associations are the 15 countries of the European Union plus Norway and Switzerland. This study is focused on the cross-border transmission capacity between these 17 countries, thus not including the borders between CENTREL and the western part of UCTE or other interconnections.

B.2 Technical aspects of interconnected transmission systems

B.2.1 Power balancing

Electricity is not storable in sufficient quantity, and therefore cannot be produced in advance of being consumed. The size of electrochemical (batteries) or electromagnetic (super conductive coils) storage systems makes them impractical for the public electricity supply, except in very special cases. Therefore, power plants and networks have to be designed to maintain the power balance, i.e. to meet the momentary power demand of customers, at all times. Particularly, this requires generation reserves and regulating mechanisms in different time scales. If generation and demand are not equal, the system frequency rapidly increases or decreases, which is only acceptable within a very tight bandwidth around the nominal frequency of 50 Hz in Europe. Therefore, power balancing includes the task of frequency control.

In UCTE, for instance, short-term balancing is composed of three levels:

- a very fast decentralised automatic frequency control in some of the power plants (“primary control”),
- a centralised automatic load-frequency control in each TSO’s control centre (“secondary control”),
- and the manual activation of additional short-term reserves, also co-ordinated in the control centres.

Since generators contributing to primary control react to power imbalances regardless of their location within the interconnected system, primary response inevitably leads to temporary cross-border power transfers.

In contrast, the secondary control particularly fulfils the task to compensate the power surplus or deficit in that part of the system where it has occurred. To do this, each TSO’s secondary controller needs as input data the planned amount of power to be exchanged with the interconnected system in hourly intervals. Such “exchange programmes” have to be set up and agreed among the members of an interconnected system periodically (e.g. daily), based on the individual import and export schedules notified by the market participants.

B.2.2 AC transmission

As already mentioned, the European electricity transmission systems are mainly (extra) high-voltage three-phase AC networks, with the exception of few DC connections. The special characteristics of

AC transmission are described in this section, while DC transmission aspects are discussed in the following one.

From a technical point of view, the components of AC transmission systems are mostly „passive“ elements that do not allow any control of the power flows across them. Rather, the pattern of power flows is determined „naturally“ by the electric parameters of lines and transformers, the network topology, i.e. the way lines and transformers are connected in substations, and the patterns of power injected into or extracted from the network by generators and consumers.

Of course, there are some instruments for influencing power flows, like voltage controllers, transformer tap changers, switches within the substations and so-called FACTS elements („Flexible AC Transmission Systems“), but during normal system operation, the means of controlling power flows without affecting power quality or increasing power losses are very limited. This is also true for power flows on interconnection lines across borders because there is no technical difference between AC lines within a TSO’s area and those across borders.

As an example of natural power flow patterns, fig. B.4 shows the most essential incremental power flows resulting from an incremental power transport of 1000 MW from Northern France to Italy, as has been given in [1] as a result of power flow simulation. The percentage values in the figure relate to the total volume of 1000 MW. This example demonstrates that large parts of the interconnected power system are considerably affected by such international transports.

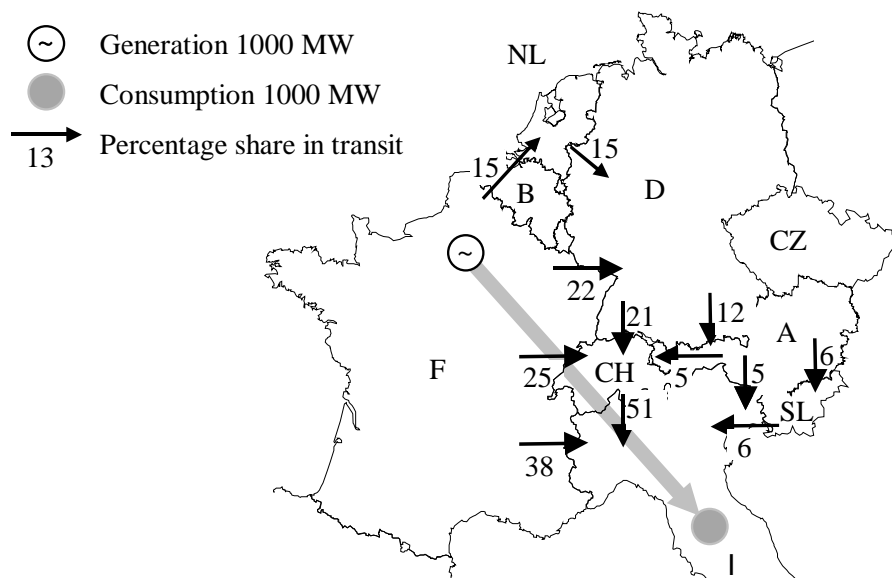

Fig. B.4: Power flow distribution of a 1000 MW transport from Northern France to Italy (simulation results; only major flows shown) [1]

Power flows through the transmission system of a TSO caused by transports between the systems of other TSOs are usually divided into „transit flows“ and “parallel flows”. (The latter are sometimes also referred to as „loop flows“.) There is no strict definition of these terms, but usually transits are considered to flow through systems on the „direct“ path from source to sink or the path that has been arranged by contracts between market actors and TSOs („contract path“), whereas parallel flows are those flowing through the remaining systems.

The problem of parallel flows affecting third systems is not exclusively related to cross-border transactions, although its relevance is of course higher in an environment with significant cross-border trade. Moreover, in a meshed synchronous interconnection, parallel flows affect not only a few TSOs, but *all* TSOs unless they are connected to the remaining system by only one line. Of course, the parallel flows may be very small in some systems, but almost never equal to zero. Reversely, it is not possible in a meshed AC network to identify a limited number of power injections or extractions that contribute to the power flow on a specific line, because practically *all* injections and extractions affect *each* line flow to some extent.

In contrast to the power flow on specific lines, TSOs do have control over the total exchange balance between their area of responsibility (also called control area) and all adjacent areas. This is achieved by the secondary control mechanism described in the previous section.

The AC transmission technology is – in contrast to DC transmission – inevitably associated to the generation, consumption and transport of so-called “reactive power”. In contrast to “active power” that can effectively be transformed into the desired form of energy by the consumer’s equipment, reactive power is not usable. It is however consumed and/or produced (depending on its definition, and on the network status) by network elements, and its transport occupies a part of the existing transmission capacity.

The transport of reactive power is closely related to the profile of voltages at the network nodes. For reasons of voltage stability, loss minimisation and maximisation of available transport capacities, transports of reactive power are normally tried to be kept as small as possible. To achieve this, a number of reactive power sources are operated under automatic or manual control, e.g. so-called compensation devices (coils or capacitors) and generating units which are usually capable of producing reactive power in addition to active power within certain limits.

B.2.3 DC transmission

In addition to synchronous AC interconnections, several high-voltage DC lines have been built in Europe to link different interconnected systems to each other or to islands, for example between Eng-

land and France, between Denmark and Norway/Sweden, between Germany and Denmark/Sweden and between Italy and Corsica, and further ones are planned. Reasons to choose DC technology in certain circumstances are

- to connect different AC interconnections in an asynchronous way, for example to avoid stability or short-circuit current problems,
- to cross long submarine distances, which is not possible in AC technology, or
- to have control over the power exchanged between two areas.

The costs of DC links are however much higher than those of AC links, at least with respect to the range of realistic transport distances within Europe, because AC/DC converter stations are needed on both sides to integrate the lines into AC transmission systems. Apart from that, laying submarine cables is very costly, anyhow.

With respect to power flow, DC lines crucially differ from AC lines in being „active“ network elements: The converter stations, today consisting basically of high-power semiconductors, are directly controlled, so that the power flow across a DC line is not the result of network topology and generation/consumption patterns, but is determined by a programme that has to be input into the controller. Therefore, the amount of power to be exchanged via each single DC line has to be notified in advance for each time interval. For this reason, the problem of parallel flows does not exist in the case of DC lines.

B.2.4 Network security requirements

In normal operation of electricity networks, a number of technical limitations related to individual network components (e.g. thermal transfer capacities of lines and transformers) or to the proper function of the network as a whole (e.g. voltage limits and stability requirements) have to be respected at all times in order to avoid supply interruptions or damage to the network, to persons or other damage.

On top of that, a minimum level of technical redundancy of the network has to be maintained at all times to ensure that the system can continue to properly operate even in case of unforeseeable unavailability of network components. Since however there will never be sufficient redundancy to cover each conceivable combination of component outages, TSOs have developed planning and operating criteria that are applied to ensure a reasonable and broadly accepted level of network reliability.

A very common criterion like that is the (n-1) principle according to which each network must be able to withstand the sudden outage of an arbitrary network component or generating unit at any time without intolerable violation of technical limitations or interruption of supply to any customer. The Euro-

pean transmission networks are basically designed and operated according to this principle or, with respect to critical locations or outages, even to the (n-2) principle which is defined correspondingly.

The fulfilment of the applied security criteria has to be assessed not only in network planning, but also in operation, be it periodically or in connection with operating actions that may affect network security. To do so, network operators apply simulation tools that explicitly simulate the effects of outages or combinations of outages (“contingencies”) on power flows, voltages and/or network stability.

The definitions of commonly applied security criteria leave however significant space for interpretation to the network operators. This for example applies to the selection of contingencies, the toleration of small violations of technical limits, the selection of the relevant network loading situations to be assessed, etc. Such decisions are largely at the discretion of each network operator, and they require a more or less explicit risk assessment because a more generous interpretation of security principles may lead to more damage or supply interruptions, while a more conservative interpretation may lead to a higher demand for corrective actions, possibly including restrictions and costs for the network users.

In meshed AC transmission systems, the operational (n-1) security requirement has the consequence that capacity margins have to be reserved on lines and transformers at all times because power flows may increase in contingency cases, driven by the “natural” power flow distribution rather than by the setting of control devices (see section B.2.2).

This is different for DC connections: being controllable transmission devices, DC lines will never be subject to an unforeseen increase of power flow due to the outage of system components. Therefore it is not necessary to reserve capacity margins on DC lines in order to fulfil the (n-1) principle. DC links can rather be operated at their rated power, unless there are limitations inside the adjacent AC networks.

The failure of a DC link itself can be regarded equivalent to a sudden electricity surplus on one side and a sudden shortfall on the other side. The systems on both sides of the link thus have to be capable of adapting total generation after such an event quickly enough, which is similar to the requirement to withstand the outage of generating units without supply interruptions.

B.3 Access to transmission systems

B.3.1 Basic principles

One of the key elements required by the directive 96/92/EC to achieve the desired opening of the electricity market is open access to the existing electricity networks since these are expected to remain

basically a natural monopoly: with the exception of a limited number of so-called “direct lines”, it will normally not be economic to duplicate the existing networks. To achieve non-discriminatory network access, the directive requires the formerly vertically integrated electric utilities to unbundle at least their accounts with respect to network operation and any other activities. For the transmission level, an independent (at least in management terms) transmission system operator (“TSO”) shall be designated in each country or area to ensure non-discrimination in system use between the incumbents and new entrants.

Regarding the organisation of network access, Member States are given the choice between three models:

- third party access based on published tariffs applicable to all customers (“Regulated third party access”),
- third party access based on negotiations between the market parties and network operators, with published main commercial conditions (“Negotiated third party access”),
- and the so-called “Single Buyer” model that leads to similar conditions for network access as regulated third party access.

Whichever model for network access is opted for, commercial and technical frameworks for network access have to be agreed among network operators, network users, and regulatory authorities (if such exist), in order to facilitate proper functioning of the electricity market.

The electricity directive does not contain specific rules for the organisation of cross-border transmission, which is however considered a key issue for the implementation of a true internal electricity market. To create a platform for discussion about the progress of the implementation of the directive with particular focus on cross-border trade, the European Commission, in 1998, initiated the creation of the European Regulatory Forum for electricity, meeting approximately twice a year in Florence, Italy. While at the beginning of this so-called “Florence process” the financial conditions of cross-border transmission access have been given most attention, technical issues like capacity allocation, congestion management and information exchange are currently gaining more importance.

Generally, technical arrangements for cross-border transmission access as well as “internal” access to the national networks have to be designed such as

- to allow TSOs to always ensure secure network operation, taking into account that they are no longer involved in planning generation dispatch, but have to be informed by market participants about the desired trading transactions and/or the resulting generation dispatch,

- to facilitate the assessment of existing transmission capacities against the transmission demand of market parties in order to anticipate possible network congestion, and to introduce mechanisms for allocating scarce transmission capacity to market parties, and
- to facilitate effective countermeasures to be taken by the TSOs in case secure network operation is immediately threatened by network congestion.

The occurrence of network congestion is not only associated to cross-border transmission, but just as well to transmission inside the national transmission grids. Since interconnections between national transmission systems have however not been built with the primary objective of facilitating bulk cross-border trade, congestion is more likely on the cross-border interfaces than inside countries.

In the above list, an essential distinction has been made between two phases of network access that reveals two different aspects of the term “network congestion” (cf. fig. B.5):

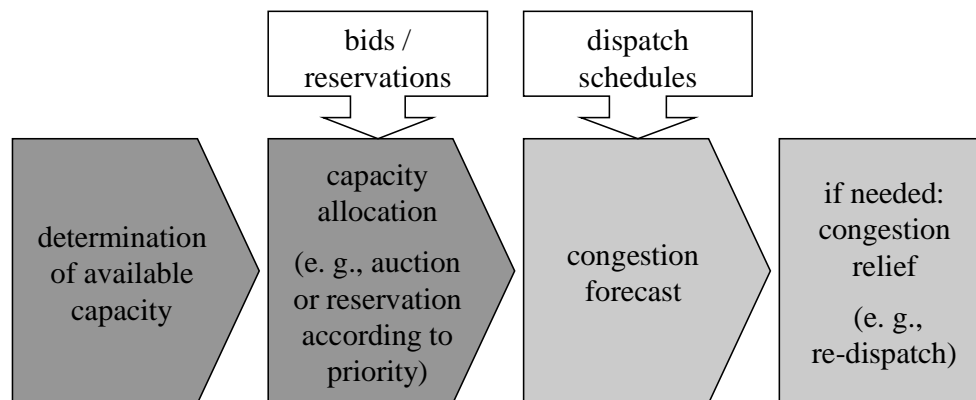

Fig. B.5: Phases of network access with respect to network congestion

- If the occurrence of congestion can be anticipated by TSOs because the market parties’ transmission demand across a specific network interface exceeds the existing capacity more or less permanently, the only practically feasible and economically sensible solution will be to allocate the existing capacity in advance to market parties and thus to impose limitations on their trading activities. This saves the TSOs from excessive costs for later congestion management, whereas market parties will incur opportunity costs caused by such limitations. Mechanisms applied for this purpose will be referred to in this study as “capacity allocation” procedures. Typical examples are auctioning procedures, reservation procedures based on priority rules, or “market splitting”.
- Irrespective if a transmission capacity across a specific network interface is allocated in advance or not, TSOs have to assess network security as a part of their operational planning activities, as soon as actual information about the planned generation dispatch is submitted by the market par-

ties. If network congestion is detected at this stage, i.e. if secure network operation based on the submitted schedules is not considered possible, it is up to the TSOs to initiate countermeasures to relieve the congestion and thus to facilitate secure network operation. This stage of the process is below referred to as “congestion management”. Typical countermeasures to be taken are adjustments of the network topology or (if such exist) devices like phase-shifting transformers that have an influence on power flows, or adjustments of generation dispatch initiated by the TSOs (“re-dispatch”).

In this study, the term “congestion” is used in its broader sense, including cases where capacity is allocated to market parties in advance to avoid excessive congestion in the short term. Congestion is thus regarded generally a lack of transmission capacity, evaluated by the “unconstrained” transmission demand of the market parties.

In case of the application of capacity allocation procedures, the allocable amount of capacity has to be determined in advance, irrespective which allocation method is actually used. General principles of the determination of available transmission capacity are discussed in the sections below.

An essential characteristic of the operation of the European interconnected transmission systems that should be highlighted is their decentralised organisation, according to which each TSO has sole responsibility of the secure operation of his own network, while respecting technical rules that have been agreed among the interconnected TSOs to ensure secure interoperability of the different systems.

Due to this form of organisation, and due to the absence of internationally harmonised and comprehensive technical network access arrangements, cross-border transmission access in Europe is still dominated by the “contract path” principle: Market parties have to determine a path of control areas from the source to the sink area of a desired transaction, and have to acquire transmission rights for each interface on this path as far as capacity allocation procedures are applied. This mechanism is used by the TSOs to determine consistent exchange programmes of all control areas despite the decentralised organisation of network access and operation. Technically, the inclusion of an inter-area power transaction into the exchange programmes of the source and sink areas is a prerequisite for the actual physical power exchange. However, the contract path principle leads to a discrepancy of contractual and physical power flows, which threatens network security or, to avoid this, implies to reserve significant capacity margins for security reasons.

One should note that this restriction is not valid for DC interconnections. Due to their controllability, it is quite simple to determine which market actors contribute to the power flow on each DC line, because all desired transports have to be notified in advance for being aggregated and programmed. In other words, the physical transmission path is, in contrast to AC systems, identical to the contract path.

B.3.2 Definitions of transmission capacity

As stated above, the determination of transmission capacities is an indispensable step of the application of capacity allocation methods. The methods applied for capacity determination by different TSOs are however quite different in many respects, not only caused by different historically developed criteria and standards, but also due to differences in the risk attitude regarding the necessary trade-off between security margins and the amount of capacity made available to the market.

(It should be noted that in the UCTE area, a rule has been agreed which can impose additional limits on allocable transmission capacity. According to this rule, transmission capacity between two areas can never be allocated in excess of the sum of power transfer ratings of the tie lines directly connecting these two areas [2]. However, the limits set by this rule are in most cases above the limits obtained by capacity determination methods based on technical simulations.)

In 1999, short after founding ETSO and as a consequence of the Florence process, TSOs have decided to determine and publish non-binding values of cross-border transmission capacity for all borders within the area covered by ETSO, independent from the publication of allocation-relevant capacities by some of the TSOs. The objective of this was to provide the market with indicative information on transmission capacities on the basis of uniform definitions. For this purpose, ETSO has developed definitions for transmission capacity values in 1999 along with a rough description of how to assess these values. These definitions have been applied for the assessment of “net transfer capacity” (NTC) values that have been published by ETSO twice a year since winter 1999/2000.

As the practical application of these definitions raised some ambiguities in interpretation and problems of compatibility with capacity allocation procedures, ETSO has developed new definitions in 2001 as follows:

TTC (“total transfer capacity”) is the maximum exchange programme between two areas compatible with the operational security standards of the respective TSOs if future network conditions, generation and load patterns were perfectly known in advance.

TRM (“transmission reliability margin”) is a security margin that copes with uncertainties on the computed TTC values arising from

- unintended deviations of physical cross-border power flows during operation due to the effects of “load-frequency” regulation (= “secondary control” in UCTE area),
- emergency exchanges between TSOs to cope with unexpected imbalances in real time, and
- inaccuracies, e.g. in data collection and measurements.

NTC (“net transfer capacity”) is the maximum exchange programme between two areas compatible with security standards applicable in both areas and taking into account the technical uncertainties on future network conditions ($NTC = TTC - TRM$).

AAC (“already allocated capacity”) is the total amount of allocated transmission rights, whether they are physical tie line capacity or exchange programmes depending on the allocation method.

ATC (“available transfer capacity”) is the part of NTC that remains available after each phase of the allocation procedure, for being allocated in a further step ($ATC = NTC - AAC$).

However, these new definitions are so far only suggestions, and they still leave significant degrees of freedom to the TSOs regarding the process of NTC assessment. This process is discussed in more detail below and in section 3 of this report.

B.3.3 NTC Assessment

In this section, the basic principles of the determination of NTC values are described in a generic way that is applied similarly by all TSOs. At the same time, issues that open up space for individual interpretation as well as uncertainties associated to this determination process will be pointed out as a basis for the later discussion of methods and criteria actually applied by the TSOs. Most of the aspects discussed here apply also to the determination of allocable capacities for the allocation procedures because this is normally based on the same basic algorithm.

The starting point of NTC assessment is a network model for technical simulations representing one load and generation situation of the network, below referred to as the base case. This base case should be as realistic as possible, including a “normal” situation of cross-border transports. In selecting an appropriate base case, TSOs are already confronted with uncertainties because of the unpredictability of load and generation. A possibility to cope with this uncertainty is to take into account multiple base cases, representing a realistic range of load and generation situations. One typical example of generation-related uncertainty that even remains in the very short term is the prediction of wind generation.

Starting from the base case, the transmission capacity, e.g. between two countries, is determined by stepwise increasing the power exchange between these two countries and by assessing through simulation the maximum exchange that is feasible without breaching the limits of network security. The amount of commercial exchange between the two countries which is already present in the base case is added to this exchange in order to reflect the pre-loading of the transmission system.

The increase of power exchange is normally modelled by an increase of power generation in the exporting country and an equivalent decrease of power generation in the importing country at the same time. This step also requires a number of assumptions to be made, since the geographic distribution of the generation increase within the exporting and the generation decrease in the importing country is not uniquely defined, and it can significantly influence the transmission capacity across the border. Therefore each TSO has to specify for his calculations the way in which the increase and decrease of generation is distributed among the existing generating units. This requires to trade off between modelling effort on the one hand and the risk of under- or overestimating capacities on the other hand, due to unrealistic dispatch assumptions. For example, if transmission capacity is limited by thermal ratings of lines, the worst case assumption is normally an increase and decrease of generation close to the investigated border, whereas if stability problems are more critical, an increase and decrease of generation far away from the border is normally more restrictive.

As discussed already in section B.2.4, the technical details of network security assessments which are also applied in the determination of transmission capacity require a lot of individual specifications by TSOs, based on a more or less explicit individual risk analysis. This applies for example to the selection of contingencies to be assessed, and for the definition of tolerances regarding slight overloads during contingencies.

Additionally, the assessment of NTCs requires the specification of TRMs which have explicitly been introduced to cover further uncertainties. (There is however no strict definition which types of uncertainties are covered by TRM and which ones should already be taken account of in the determination of TTC.) A rigorous way to specify TRM would be to evaluate comprehensive statistical data on the relevant uncertain parameters, but such data is often not available in sufficient detail.

Finally, a fundamental and general problem of the determination of capacity values for transports from one area to another shall be highlighted. As stated before, power transactions in a meshed transmission network influence the power flow on practically all the lines of the network. In consequence, the transmission capacity across a specific interface between two areas is not only influenced by exchanges between those areas, but also by almost any other exchanges in the interconnected system. Therefore transmission capacities in a meshed system cannot be defined independently from each other.

Nevertheless, the usual algorithm for capacity determination is based on the implicit assumption that additional capacity as compared to the underlying base case is only allocated for one network interface at a time. This simplification facilitates the determination and the understanding of capacity values, but does not correctly reflect reality because capacity allocation of course takes place at several bor-

ders at the same time. We assume that this problem can only be overcome by a comprehensive and harmonised approach to capacity allocation covering large parts of the interconnected system, e.g. by the “co-ordinated auctioning” approach that is currently under discussion.

C Present state of cross-border access to transmission networks

C.1 General country-related information on transmission access

C.1.1 Key figures on electricity supply

In the table below, we summarise general data regarding area, population, electricity consumption and generation of the countries in the scope of this study. This shall serve as background information for the later evaluation of transmission capacities.

Country	Area [km ²]	Population [mio]	Installed generation capacity [MW]	Maximum system load [MW]	Total Generation [GWh]	Total consumption [GWh]	Net imports [GWh]
Austria	83 900	8.1	16 200	7 700*	54 100	52 700	-1 400
Belgium	30 500	10.2	15 600	12 300*	80 200	84 500	4 300
Denmark	43 000	5.3	11 900	6 300	34 200	34 900	700
Finland	338 000	5.2	16 600	12 700	67 200	79 100	11 900
France	544 000	58.6	110 800	66 900*	504 000	433 200	-69 900
Germany	357 000	82.0	103 700	74 300*	496 600	499 700	3 200
Great Britain	243 300	59.0	75 305	57 800	345 600	331 400	14 200
Greece	132 000	10.5	18 800	7 700*	45 200	45 200	0
Ireland	70 300	3.7	4 800	3 800		21 200	
Italy	301 300	57.6	75 900	49 000*	262 400	306 900	44 500
Luxembourg	2 600	0.4	1 200	900*	1 100	6 900	5 700
Netherlands	41 500	15.6	18 600	12 300*	52 900	71 800	18 900
Norway	324 000	4.5	27 800	20 400	142 800	123 800	-19 000
Portugal	92 400	9.9	9 600	6 200*	37 600	38 500	900
Spain	504 800	39.7	49 000	32 400*	195 400	199 800	4 400
Sweden	450 000	8.9	30 900	26 000	141 900	146 600	4 700
Switzerland	50 000	8.9	17 200	9 000*	65 400	58 400	-7 000

Table C.1: Key figures on electricity supply in Europe (*: Peak load on the 3rd Wednesday in 2000); sources: UCTE-Statistical Yearbook 2000, NORDEL-Annual Report 2000, Fischer Weltatmanach 2000, <http://www.electricity.org.uk>, <http://www.esb.ie>

C.1.2 Status of electricity market opening

According to the electricity directive 96/92/EC, the member states have been allowed to open their electricity markets stepwise. The table below gives an overview of the current degrees of market opening, including also the non-EU countries Norway and Switzerland.

Country	definition of eligible costumers	degree of market opening	Year of legal implementation of market opening
Austria	all	100 %	1999
Belgium	> 20 GWh/a	33 %	2000
Denmark	> 1 GWh/a	90 %	1998
Finland	all	100 %	1997
France	> 16 GWh/a	30 %	2000
Germany	all	100 %	1998
Great Britain	England, Wales, Scotland: all Northern Ireland: > 0,97 GWh/a	E, W, S:100 % N.I.: 35 %	1989
Greece	> 100 GWh/a	26,5 %	2001
Ireland	> 4 GWh/a	28 %	2000
Italy	> 20 GWh/a	35 %	1999
Luxembourg	> 20 GWh/a	45 %	2000
Norway	all	100 %	1991
Netherlands	> 20 GWh/a or > 2 MW	33 %	1999
Portugal	> 9 GWh/a and distributors for 8% of their consumption	>33%	1995
Spain	all high voltage costumers	54 %	1998
Sweden	all	100 %	1996
Switzerland	none	0 %	-

Table C.2: Status of electricity market opening in Europe (as of October 2001)

C.2 Regulators, TSOs, network access and market organisation

The tables below give an overview over

- the regulatory authorities,
- the transmission system operators (TSOs),
- the general network access regimes (SB, RTPA, NTPA),

- the existence of market rules and/or technical rules like grid codes, and
- the existence of organised markets like power exchanges and their influence on the allocation of cross-border transmission capacity

in the countries covered by the scope of this study.

Country	Austria
Regulator	Elektrizitäts-Control GmbH Kärntnerring 5-7/7, A-1010 Wien, www.e-control.at
TSOs	Verbund-Austrian Power Grid GmbH (APG) Parkring 12, A-1010 Wien, www.apg.at
	Powergrid-Tiroler Wasserkraftwerke AG Eduard-Wallnöfer-Platz 2, A-6010 Innsbruck, www.powergrid.at
	Vorarlberger Kraftwerke AG Weidachstraße 6, A-6901 Bregenz, www.vkw.at
Network access	RTPA
Market rules/ Gridcode	„Technical and organizational rules for carriers and users of distribution and transmission networks“ („Technische und organisatorische Regeln für Betreiber und Benutzer von Verteil- und Übertragungsnetze“ - TOR) (valid from 01.10.2001)
Power exchange	In spring 2002 an independent power exchange, the Alpen Adria Power exchange (AAPEX), shall open. It will be based on a spot market system and will have no influence on the allocation of cross-border capacity.

Country	Belgium
Regulator	Commission de Regulation de l'Electricite et du Gas (CREG) Rue Wiertz 50, B-1050 Bruxelles, www.creg.be
TSO	ELIA Bd. de l'Empereur 20, B-1000 Brussel, www.elia.be
Network access	RTPA, plus NTPA as an option for transmission of large volumes of electricity and transits of electricity between transmission grids
Market rules/ Gridcode	planning stage
Power exchange	none

Country	Denmark
Regulator	Danish Energy Regulatory Authority (Energitilsynet) Nørregade 49, DK-1165 København, www.ks.dk
TSOs	Elkraft System a.m.b.a. Lautruphøj 7, DK-2750 Ballerup, www.elkraft-system.dk
	Eltra Fjordvejen 1-11, DK-7000 Ferdericia, www.eltra.dk
Network access	RTPA
Market rules/ Gridcode	”Market Regulations” (”Markedforskrifter”) Grid Code is common for all NORDEL members
Power exchange	Nord Pool: spot and future market with allocation of cross-border capacity to the NORDEL members

Country	Finland
Regulator	The Energy Market Authority Eteleinen Makasiinikatu 4, FIN-00130 Helsinki, www.energiainfo.fi
TSO	Fingrid Oyj Arkadiankatu 23B, P.O:Box 530, FIN-00101 Helsinki, www.fingrid.fi
Network access	RTPA
Market rules/ Gridcode	”General connection terms of Fingrid Oyj’s grid” (Fingrid Oyj: N Yleiset Liittymisehdöt”); ”Fingrid Oyj’s main grid service conditions, 1.1.1999”(“Fingrid Oyj: N Kantaverkopalveluehdöt 1.1.1999”) Grid Code is common for all NORDEL members
Power exchange	Finnish electricity exchange (EL-EX) participates in Nord Pool, the objective is to merge EL-EX with Nord Pool. Cross-border capacities to the NORDEL countries are allocated by Nord Pool.

Country	France
Regulator	Commission de Régulation de l'Électricité 149, rue de Longchamp, F-75116 Paris, www.cre.fr
TSO	Reseau de Transport Electricite (RTE) 34-40, rue Henri Régnauld, F-92068 Paris la Défense Cedex 48
Network access	RTPA
Market rules/ Gridcode	Different contracts for import, export and transits of electricity; "RTE-Balancing-Market-Rules"; planning stage: "Network code" ("Code de Reseau")
Power exchange	On July 30th 2001 the Powernext SA was founded. It will be based on a spot market system and will have no influence on the allocation of cross-border capacity. A training and market simulation phase has started in September 2001.

Country	Germany
Regulator	none
TSOs	<p>Bewag AG Puschkinallee 52, D-12435 Berlin, www.bewag.com</p> <p>EnBW Transportnetze AG Kriegsbergstraße 32, Postfach 101362, D-70012 Stuttgart, www.tngsl-enbw.de</p> <p>Hamburgische Electricitäts-Werke AG (HEW) Überseering 12, D-22297 Hamburg, www.hew.de</p> <p>RWE Net AG Flamingoweg 1, D-44139 Dortmund, www.rwenet.com</p> <p>E.ON Netz GmbH Luitpoldplatz 5, D-95444 Bayreuth, www.eon-energie.com</p> <p>VEAG Vereinigte Energiewerke AG Chausseestr. 23, D-10115 Berlin, www.veag.de</p>
Network access	NTPA or SB possible; all TSOs have opted for NTPA
Market rules/ Gridcode	„GridCode 2000“; "Associations' Agreement 2" („Verbändevereinbarung 2“)
Power exchange	Leipzig Power Exchange (LPX) and European Energy Exchange (EEX): spot and future market, no cross-border capacity allocation.

Country	Great Britain
Regulators	<p>England, Wales, Scotland: Office for Gas and Electricity Markets (OFGEM) 9 Millbank, London, SW1P 3GE, www.ofgem.gov.uk</p> <p>Northern Ireland: Office for Regulation of Electricity and Gas (OFREG) Brookmount Buildings, 42 Fountain Street, Belfast, BT1 5EE, http://ofreg.nics.gov.uk</p>
TSOs	<p>The National Grid Company plc (NGC) Kirby Corner Road, Coventry CV4 8JY, www.nationalgrid.com/uk</p> <p>Northern Ireland Electricity plc (NIE) 120 Malone Road, Belfast BT9 5HT, www.nie.co.uk</p> <p>Scottish & Southern Energy plc (SSE) 200 Dunkeld Road, Perth PH1 3AQ, www.scottish-southern.co.uk</p> <p>Scottish Power plc (SP) 1 Atlantic Quay, Glasgow G2 8SP, www.scottishpower.com</p>
Network access	RTPA
Market rules/ Gridcode	<p>England & Wales: Balancing & Settlement Code, Grid Code (NGC)</p> <p>Scotland: Settlement Agreement for Scotland, Grid Codes (SP and SSE)</p> <p>Northern Ireland: administered arrangements (NIE)</p>
Power exchange	<p>England & Wales: Number of competing power exchanges (e.g. UKPX, APX, IPE). Exchanges play no role in cross-border capacity allocation</p> <p>Scotland, Northern Ireland: No power exchanges in operation</p>

Country	Greece
Regulator	<p>RAE-Regulatory Authority for Energy Panepiothmiou 69 Kai Aiolou, GR-Athens, www.rae.gr</p>
TSO	<p>Public Power Corporation – Hellenic Transmission System Operator 22, Asklipiou str., GR-14565 Krioneri, www.dei.gr</p>
Network access	RTPA
Market rules/ Gridcode	“Operating code; “Transmission Connection Agreement”; “Detailed Definition and Description of Electricity System Trading Arrangements in Greece”
Power exchange	None

Country	Ireland
Regulator	Commission for Electricity Regulation (CER) 5-9 South Frederick Street - 1floor, IR-Dublin 2, www.cer.ie
TSO	Electricity Supply Board Lr. Fitzwilliam St, IR-Dublin 2, www.esb.ie
Network access	RTPA
Market rules/ Gridcode	“Grid Code”
Power exchange	none

Country	Italy
Regulator	Autorità per l’Energia Elettrica e il Gas Piazza Cavour, I-20121 Milano, www.autorita.energia.it
TSO	Gestore della rete di trasmissione nazionale S.p.A., Viale Maresciallo Pilsudski, 92, I-00197 Roma, www.grtn.it
Network access	RTPA for eligible costumers, SB for captive costumers
Market rules/ Gridcode	“Technical rules for connection” (“Regole Tecniche Di Connessione”), ”Elecricity Market Rules” (“Disciplina del mercato elettrico”)
Power exchange	Energy Market managed by a market operator “Gestore del Mercato”. Based on a pool system with allocation of cross-border capacity.

Country	Luxembourg
Regulator	Institut Luxembourgeois de Régulation 45a, avenue Monterey, L-2922 Luxembourg, www.ilr.lu
TSOs	Cegedel S.A. 2 Rue Thomas Edison, L-1445 Strassen, www.cegedel.lu
	SOTEL
Network access	RTPA
Market rules/ Gridcode	?
Power exchange	none

Country	The Netherlands
Regulator	Dienst uitvoering en toezicht Energie (DTe) P.O. Box 16326, NL-2500 BH The Hague, www.dte.nl
TSO	Tennet b.v. Utrechtseweg 310, NL-6812 Arnhem, www.tennet.org
Network access	RTPA
Market rules/ Gridcode	“Gridcode” (“Netcode”)
Power exchange	Amsterdam Power Exchange based on a pool system without allocation of cross-border capacity

Country	Norway
Regulator	Norwegian Water Resources and Energy Directorate (NVE) Middelthunsgate 29, P.O. Box 5091 Majorstua, N-0301 Oslo, www.nve.no
TSO	Statnett SF P.O.Box 5192 Majorstua, N-0302 Oslo, www.statnett.no
Network access	RTPA
Market rules/ Gridcode	“Main grid commercial agreement” Grid Code is common for all NORDEL members
Power exchange	Nord Pool: spot and future market with allocation of cross-border capacity to the NORDEL members

Country	Portugal
Regulator	Entidade Reguladora do Sector Eléctrico (ERSE) Edifício Restelo -Rua Dom Cristóvão da Gama n °1-3 °,P-1400-113 Lisboa, www.erse.pt
TSO	Rede Eléctrica Nacional, S.A. Av. Estados Unidos da América, 55, P-1749 061 Lisboa, www.ren.pt
Network access	RTPA
Market rules/ Gridcode	“Access to the networks and the Interconnections code” (“Regulamento de acesso às redes e às interligações”); ”Rules for system management” (“Manual de Procedimentos do Gestor de Sistema”)
Power exchange	The Portuguese System Operator participates in the Spanish Pool

Country	Spain
Regulator	Comisión Nacional de Energía (CNE) Marqués del Duero, 4, E-28001 Madrid, www.cne.es
TSO	Red Eléctrica de España Pº del Conde de los Gaitanes, 177, E-28109 Alcobendas Madrid, www.ree.es
Network access	RTPA
Market rules/ Gridcode	“Electricity Market Rules” (“Reglas del Mercado de Producción de Energía Eléctrica”)
Power exchange	Electricity Pool managed by an electricity market operator (COMEESA) with cross-border capacity allocation

Country	Sweden
Regulator	Swedish National Energy Administration - Office of the Electricity and Gas Regulator P.O. Box 310, S-631 04 Eskilstuna, www.stem.se
TSO	Svenska Kraftnät P.O.Box 526, SE-16215 Vällingby, www.svk.se
Network access	RTPA
Market rules/ Gridcode	”General agreement conditions for use of the main grid” (“Allmänna Avtalsvillkor för Nyttjande av Stamnätet”) Grid Code is common for all NORDEL members
Power exchange	Nord Pool: spot and future market with allocation of cross-border capacity to the NORDEL members

Country	Switzerland
Regulator	After liberalisation of the electricity sector a “Schiedskommission” will be the responsible regulator
TSOs	Atel-Aare Tessin AG Bahnhofsquai 12, CH-4601 Olten, www.atel.ch
	BKW-FMB Energie AG Viktoriaplatz 2, CH-3000 Bern 25, www.bkw.ch
	Centralschweizerische Kraftwerke (CKW) Hirschengraben 33, CH-6002 Luzern, www.ckw.ch
	Elektrizitäts-Gesellschaft Laufenburg AG (EGL) Postfach, CH-5080 Laufenburg, www.egl.ch
	EOS-Energie Ouest Suisse Place de la gare 12, CH-1001 Lausanne, www.eos-gd.ch
	EWZ Elektrizitätswerk der Stadt Zürich Postfach, CH-8050 Zürich, www.ewz.ch
	Nordostschweizerische Kraftwerke (NOK) Parkstrasse 23, CH-5401 Baden, www.nok.ch
Etrans Werkstrasse 12, CH-5080 Laufenburg, www.etrans.ch (no TSO, but jointly founded by Swiss TSOs and responsible for capacity calculations)	
Network access	After liberalisation of the electricity sector: RTPA
Market rules/ Gridcode	not yet
Power exchange	none

C.3 Cross-border connections of the European transmission systems

This study is focused on the cross-border transmission capacities between the national electricity transmission systems of the EU member states plus Norway and Switzerland. These capacities are determined in the first place by the capacities of the cross-border interconnections themselves, which are shown in fig. C.1 through fig. C.5, region by region. Capacities for the NORDEL interconnection are taken from the latest annual report [3]. For UCTE we have computed the capacities from the thermal current limits which are included in the load flow data set provided by ETSO (cf. appendix I.1). Additional limitations according to the UCTE Statistical Yearbook 2000 [12] are mentioned where applicable. The capacities between France and Italy and Switzerland and Italy have been computed from updated information provided by GRTN (I).

It is important to note that the tie lines are not the only determining factors of cross-border transmission capacity; other factors like the internal capacities of the national systems as well as the geo-

graphic distribution of power plants can have an essential impact, too. Therefore, the indicated values must not be mixed up with the actually available transmission capacities between the countries.

Most of the relevant interconnection lines are AC lines connecting the 400 kV, 380 kV and 220 kV networks. There are also some cross-border lines operated at 110 kV, but due to their relatively low capacity these lines play a less significant role in bulk power transmission. The different synchronously interconnected systems (UCTE, NORDEL, UKTSOA) are connected to each other by DC lines that are also included in the figures below.

Power transfer capacities of AC lines or transformers are normally defined in the unit MVA, representing the maximum “apparent” power that can be transported continuously at nominal voltage. “Apparent” power includes active (i.e. usable) power, measured in MW, and reactive power, measured in Mvar. Reactive power cannot be used, but is inevitably associated to AC transmission technology (cf. section B.2.2). The amount of reactive power produced, consumed and transported by the network depends significantly on the network loading situation, so that the share of capacity remaining for active power transmission cannot be clearly defined. A reasonable estimate for the minimum capacity usable for active power transmission is approximately 90 % of the MVA capacity.

For the interconnections between the NORDEL networks, transfer capacities are already given in MW in the source that has been available to us, and therefore are represented by MW values also in the figures below. We assume that a reasonable capacity margin for the transport of reactive power has already been taken into account when determining these values.

The capacity of DC lines is generally defined in MW because in DC technology, the phenomenon of reactive power generation, consumption and transport does not exist.

Countries that are in principle in the scope of this study, but do not have their transmission systems connected with those of at least one other country in the same scope are not included in the further analysis and consequently not in the figures below. This applies basically to Greece and Ireland as well as the Scottish and Northern Irish parts of Great Britain. In addition, the network of Luxembourg is not taken into account here, because it consists of two physically decoupled systems, one of which is connected to the Belgian system and the other one to the German system, that are practically only used for the supply of the electric load in Luxembourg. This is due to the fact that Luxembourg covers only a small part of its demand by domestic generation. Therefore, the transmission capacity on the borders of Luxembourg practically cannot impose any limitations on cross-border electricity trade in Europe. (Nevertheless, the TSOs of Luxembourg have been asked to contribute to our survey with respect to network security standards applied for internal transmission considerations.)

The interconnections to countries outside the scope of this study, but adjacent to countries within this scope are indicated in the figures below by arrows just as an additional information to the reader; the capacities of these connections are however not taken into account in the further analysis.

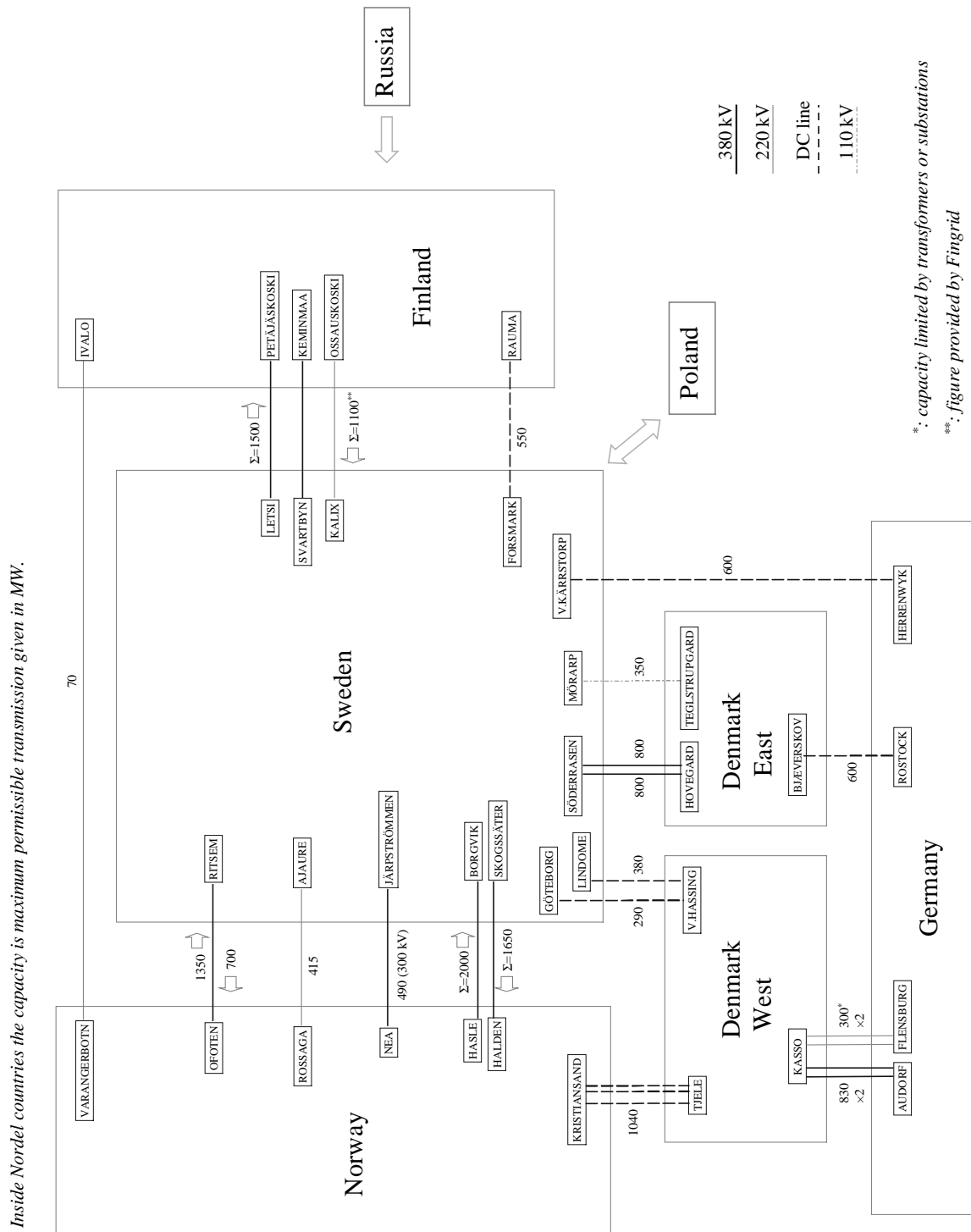

Fig. C.1: Cross-border lines between Norway, Sweden, Finland, Denmark (capacity values in MW) and Germany (capacity values in MVA, except for DC lines)

Conventional transmission capacity of tie-lines given in MVA

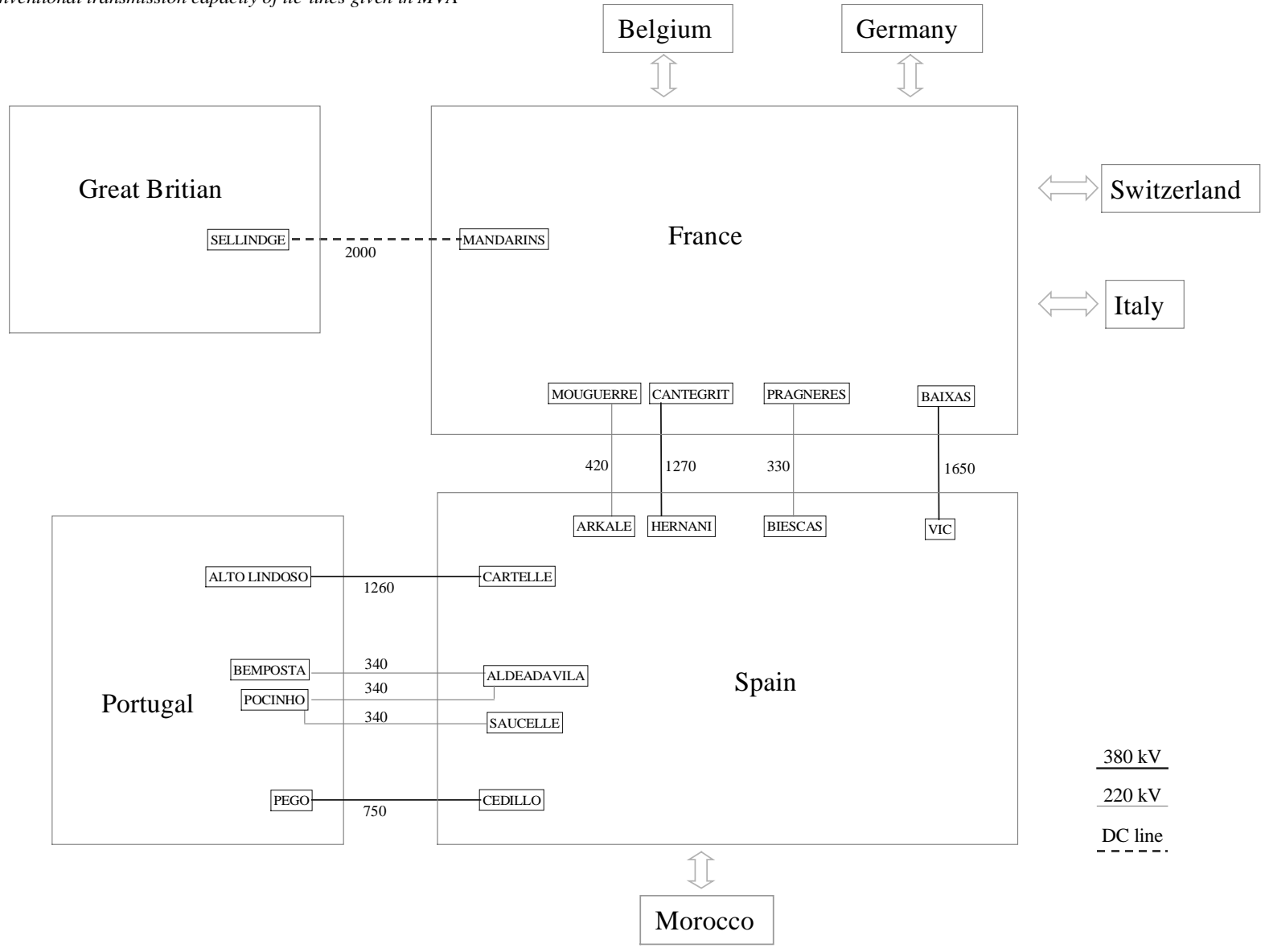

Fig. C.3: Cross-border lines between France, Great Britain, Spain and Portugal (capacity values in MVA, except for DC lines)

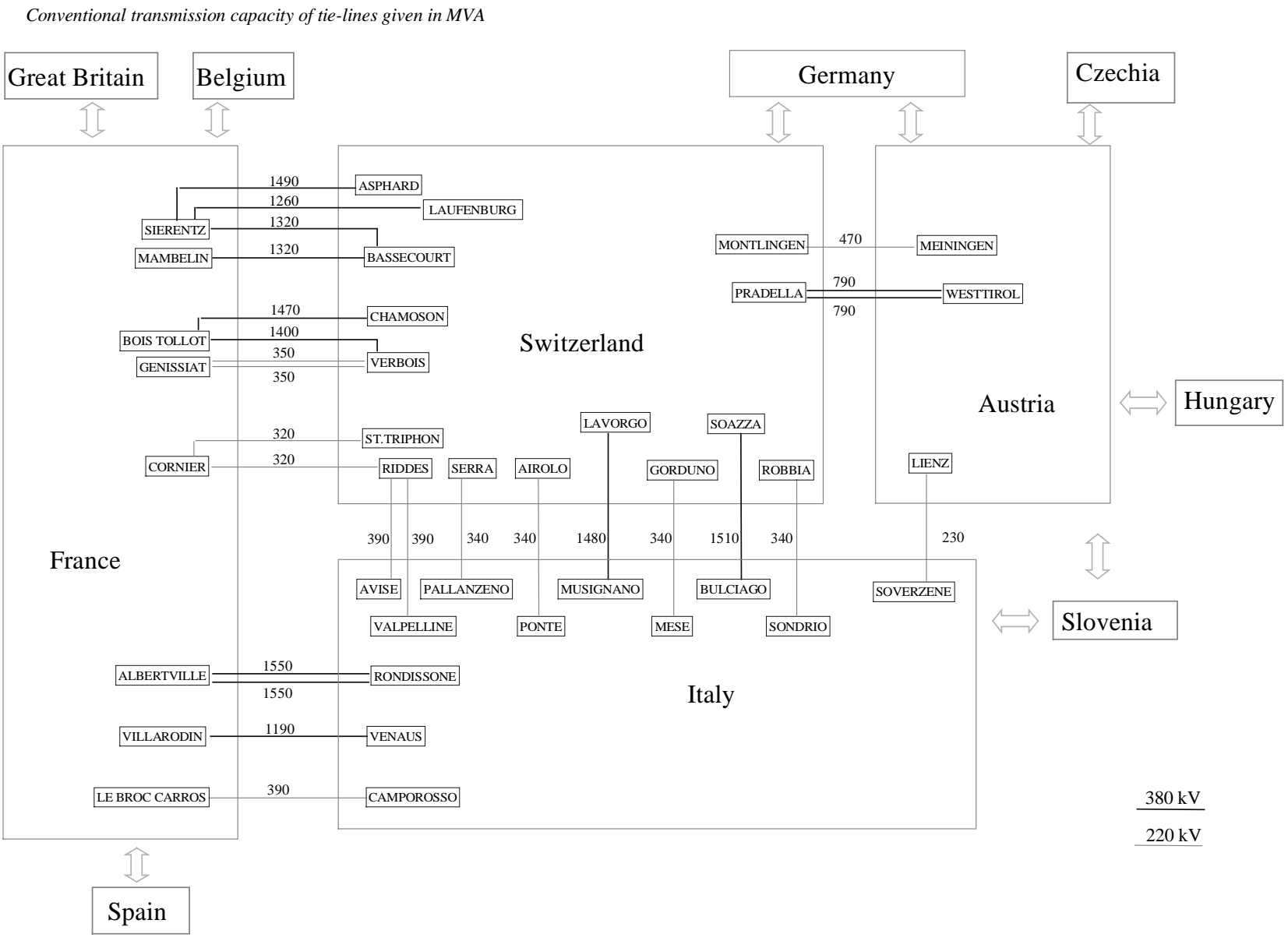

Fig. C.4: Cross-border lines between France, Switzerland, Austria and Italy (capacity values in MVA)

Conventional transmission capacity of tie-lines given in MVA

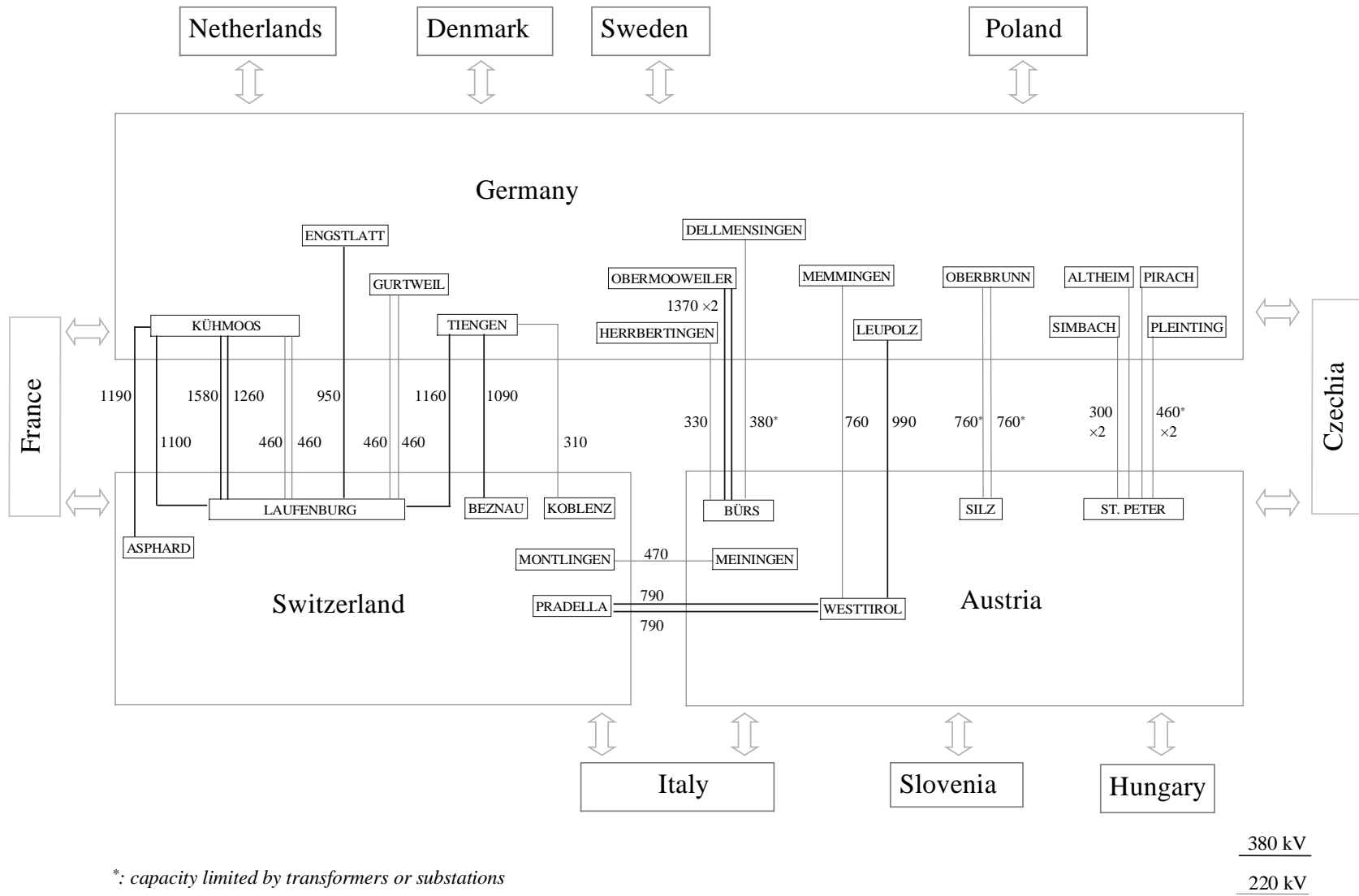

Fig. C.5: Cross-border lines between Germany, Austria and Switzerland (capacity values in MVA)

D Additional information on the determination and allocation of cross-border transmission capacity

In this appendix chapter, in-depth information is given with respect to some of the issues discussed in chapter 3 of this report.

D.1 Determination of indicative NTC values published by ETSO

D.1.1 Data base and methodology

Power system data

Most TSOs in the UCTE interconnection base their NTC assessment either on the forecasted or the recorded real load flow data sets which are jointly prepared twice a year. While formerly only the forecast data was available, there now seems to be a development towards a broader use of the snapshot situations, either completely or for a partial update of the forecast data sets. Apart from the base case selection, there are several individual solutions regarding the power system data base for NTC assessment, some of which are listed below:

- RTE (F) and TenneT (NL) individually update the model, e.g. in terms of topology, thermal line ratings or maintenance outages, if new information becomes available after the co-ordinated creation of the model.
- According to DVG (D), some German TSOs have experienced congestion situations due to transfer limits in voltage levels below 220 kV. For these cases, regional load flow models are used in addition to the common UCTE model.
- REN (P) use a set of load flow models to cover a range of possible scenarios. These models are based on a bilateral data exchange with REE (E) and cover only the Iberian peninsula. This does however not in principle restrict the applicability of the model for NTC calculation because of the peripheral location of the REN grid.
- TIWAG (A) – who have so far not experienced congestion nor computed own NTC values (the TIWAG area has been covered by Verbund APG's (A) calculations), but plan to do so in the future – note that they could use the common UCTE model only if their 110 kV interconnections were included.
- In addition to the preparation of the two complete UCTE data sets per year, two groups of TSOs have started to exchange network data on a weekly (and partly even daily) basis. Among REE (E),

RTE (F), ELIA (B), TenneT (NL), GRTN (I), German and Swiss TSOs, recorded and forecasted load flow data are exchanged, whereas the second group, i.e. VEAG (D), E.ON Netz (D), Swiss TSOs, Verbund APG (A) and the CENTREL TSOs, exchange recorded data only. While this data exchange has originally been initiated with the purpose of day-ahead congestion forecast (DACF), these load flow models can also serve as an updated data base for short-term capacity assessment.

Modelling of generation increase/decrease

In order to model the generation increase or decrease within their own network area, the European TSOs apply two different methods:

- One group of TSOs distribute the generation change **proportional to the base case** dispatch. This group comprises Verbund APG (A), Swiss TSOs/ETRANS, German TSOs, REE (E), TenneT (NL), Svenska Kraftnät (S), and Statnett (N).

Among these TSOs, all but the German TSOs take into account the installed capacities of generators to avoid fictitious line overloading caused by unrealistic dispatch assumptions. DVG (D) state that due to the high amount of overall generation the contribution of each individual generator remains small enough to justify this simplified modelling. Installed capacities will however be taken into account in the future when they are included in the common UCTE load flow model. (In contrast to the internal area, German TSOs do consider installed generation capacity in external areas in some particular cases (e.g. Eastern France) to avoid unrealistically low cross-border capacity results.)

REE (E) do not modify generation levels of nuclear power plants because these are considered to always operate at their maximum level.

Swiss TSOs/ETRANS distribute the generation shift proportional to the remaining capacity of the generators. This means that theoretically, all generator reach their maximum output simultaneously. Individual exceptions to this rule are applied to avoid unrealistically low computation results for the cross-border transmission capacity.

Svenska Kraftnät (S) distribute the generation shift proportional to the individual capacities of generating units instead of the base case dispatch. Moreover, participation is restricted to generators in specific regions based on a worst-case assumption with respect to the interconnection under study.

- In other countries (B, F, GB, I, P and FIN) TSOs use information on the generation costs of individual units to distribute the generation change according to an **estimated merit order**. This

method aims at simulating the market behaviour under the assumption of a globally economically efficient generation dispatch within each TSO's area.

As a consequence of their independence in the liberalised market, TSOs in principle do not have access to generation costs. Therefore, the information needed to economically rank the generators is acquired either by statistical analysis of the generation dispatch actually observed, or by explicit information provided by generation companies, e.g. in the context of balance service regulations (F) or because the TSO is also responsible for the centralised generation dispatch (P). (It should be noted that no absolute costs, but only a relative ranking of generators is needed to estimate the merit order.)

D.1.2 Assessment of network security

Considered types of failures

As regards single failures, the TSOs' approaches are described in section 3.2.2.

In addition to the simulation of single failures, some TSOs also investigate certain **failure combinations**, i.e. "(n-2)" outages:

- REN (P), REE (E), RTE (F), GRTN (I) and NGC (GB) consider **double circuit outages**.

REE thereby follow a rule of the detailed Spanish grid code requiring all double circuit lines beyond 30 km length to be considered in security analyses.

RTE investigate outages of "important" double circuits according to a statistical analysis of failure frequencies. (As a result of the same analysis, bus bar failures are *not* considered by RTE because they are too rare.) Based on similar considerations, REN also consider only some of their double circuits.

NGC consider all double circuit lines, stating that these could – similarly to bus bar failures in the Nordic countries – endanger voltage stability. To compensate the resulting restrictive effect on steady-state voltages, the limit for the voltage drop per failure is doubled in these cases (cf. p. 25). Regarding thermal currents, high tolerances for short-term overload are mentioned (cf. p. D-6).

GRTN consider all double circuit lines, in terms of tie lines referring to the risk of losing the synchronous connection to the UCTE network if actual double circuit failures cause a subsequent tripping of all tie lines.

- REN (P) and REE (E) additionally consider a few **combinations of a single circuit failure and a single generator outage**. At least for REE these cases are restricted to certain special regions with a lack of structural network redundancy.

D.1.3 Limits of feasible network operation

Thermal limits – assumptions on environmental conditions

The **variation of ambient temperature with respect to the time of year** is taken into account very differently by the individual TSOs:

- German TSOs, TenneT (NL), Verbund APG (A), and Eltra (DK) currently do not consider this effect at all.
- REN (P) lower the assumed outside temperature from 30 °C to 15 °C in winter. Transformed to current limits, this leads to an increase between 16 % and 48 %, depending on the maximum conductor temperature¹.
- REE (E) differentiate on a monthly basis using temperature statistics for each individual line (i.e. that for each substation, meteorological data from the closest weather station is taken into consideration). For winter and inter-season months, the average daily maximum temperature is used to derive thermal current limits. For summer months, the average monthly maximum (i.e. a higher value) is used, because only in summer the highest daily temperature and peak load coincide (air-conditioning).

For the ETSO summer/winter NTC values, the maximum temperature of the respective six months period is considered. Transformed to current limits, the difference between minimum and maximum values amounts to about 20 % on the important tie lines.

- RTE (F) apply a probabilistic approach. Based on statistics on temperature, wind speed and solar radiation for three geographic regions, thermal currents have been derived so that the maximum conductor temperature is exceeded with a probability of 3 %. The results can be expressed in terms of ambient temperature assumptions, which are differentiated in four seasons for simplicity

¹ When lowering the assumed outside temperature, the gap between outside temperature and maximum conductor temperature increases. The relative increase of this gap is larger for lines with low maximum conductor temperature than for those with high allowed conductor temperature.

(and, according to RTE, with minor loss of accuracy): Nov 10 to Apr 20 (15 °C), Apr 20 to May 10 (21 °C), May 10 to Sep 20 (30 °C), and Sep 20 to Nov 10 (21 °C). In cold winter, the temperature assumption is lowered to 5 °C. (All temperatures are related to the northernmost of three geographical regions.) The range of current limits resulting from this differentiation amounts to about 25-30 % above the minimum value. When calculating ETSO NTC for winter and summer, temperatures in a range from 9 °C to 17 °C and 21 °C to 29 °C are applied, respectively.

- NGC (GB) consider five seasons: December to February, March to April, May to August, September to October, and November. Similar to RTE, a probabilistic approach, taking into account ambient temperature and wind speed, is used. Thermal current limits are derived so that the probability of excessive conductor temperature is 0.1 % in normal operation (and 12 % in contingency situations).
- ELIA (B) also apply a probabilistic approach based on statistical weather data. The probability threshold for excessive conductor temperature is 10 %. The resulting assumptions on ambient temperature yield a difference of 12 % between highest and lowest thermal current limits. Four different seasons are considered: spring (Mar 15 to May 15), summer (May 16 to Sep 15), autumn (Sep 16 to Nov 15), and winter (Nov 16 to Mar 14).
- GRTN (I) use thermal current limits provided by the Italian grid owners. For the tie lines, an ambient temperature of 30 °C in summer and 10 °C in winter is assumed. For internal lines, constant values are applied so far, because the necessary agreement for data exchange between GRTN and the grid owners has not been signed yet.
- Swiss TSOs/ETRANS consider a temperature of 10 °C in winter (compared to 40 °C in summer).
- Statnett (N) consider 0 °C in winter and 20 °C in summer for NTC calculation. Regarding day-ahead assessment of allocable capacities, temperature forecasts are used including a day/night differentiation and three different geographical regions.
- Svenska Kraftnät (S) make a summer/winter differentiation for a few selected lines where thermal limits restrict cross-border capacity. There are plans to extend the differentiation to further lines. Similar to Statnett (N), temperature forecasts including a day/night differentiation are used for the day-ahead assessment of allocable capacities.
- Fingrid (FIN) take into account three different temperature ranges (10..20 °C, 20..25 °C, >25 °C).
- TIWAG (A) assume an increase of the admissible line currents by 20 % from November to beginning of March.

Besides the ambient temperature, **wind speed** and direction also have a significant effect on conductor cooling and therefore on the relation between line current and conductor temperature. Unfortunately, the wind parameters do not follow an annual cycle in the way temperature does. Therefore, almost all TSOs so far assume a constant value for the average wind speed throughout the year:

- A wind speed of 0.6 m/s is applied by German TSOs, REN (P), Fingrid (FIN), TenneT (NL), REE (E), Verbund APG (A), TIWAG (A), Eltra (DK), Statnett (N), and Svenska Kraftnät (S).
- A wind speed of 0.5 m/s is applied by Swiss TSOs/ETRANS and ELIA (B).
- NGC (GB) and RTE (F) imply statistical wind data in their probabilistic approaches to derive thermal current limits.

Thermal limits – temporary overload

In chapter 3.2.3, an overview is given on how much overload of network branches – separated by internal lines, tie lines and transformers – is tolerated by the European TSOs in cases of (n-1) contingencies, i.e. outage of a single network element. Several TSOs apply specific rules that reach beyond the specification of a single percentage value:

- REE (E) also consider (n-2) failures; in these cases, a transformer overload between 10 % and 20 % is tolerated depending on the time of year.

Regarding the tie lines to France, REE state that these have an extreme importance for the stable supply of the whole Iberian peninsula, because they constitute the only connection to the rest of the UCTE system. Therefore, the accepted risk of an actual thermal overload is lower than for the internal lines, which results in post-fault current limits being equal to the pre-fault values.

- NGC calculate the tolerated continuous overload by means of a probabilistic analysis. During undisturbed operation a risk of 0.1 % is accepted that the conductor temperature exceeds its limit (under consideration of statistics on wind speed and temperature). For post-fault situations, this risk threshold is raised to 12 % which equivalents to the thermal rating increased by 19 % for continuous current. Short-term limits (i.e. prior to corrective measures) reach up to 150 % of this continuous post-fault rating (i.e. an overload of 50 %).
- RTE (F) accept a continuous post-fault conductor temperature of 75-90 °C (depending on the line) instead of 65 °C in undisturbed operation. In addition, RTE tolerate 20 % to 50 % of short-term overload depending on the availability of fast corrective measures (three time frames: <1 min (automatic measures), <10 min, continuous operation). However, to take into account measuring errors, only 85 % of the 1 min limits and 95 % of the 10 min limits are actually accepted during

security analysis. Thus, short-term post-fault ratings are in a range of 115-125 % of the continuous ratings (i.e. 15-25 % of short-term overload).

- At Statnett (N), tolerated (n-1) overload depends on the branch load immediately before the occurrence of the failure. The value of 20 % indicated in fig. 3.4 on page 24 represents the maximum limit.
- Svenska Kraftnät (S) actually accept the conductor temperature to exceed its normal rated value by 20 °C. This rule is individually transformed into a current limit per line; thus, the value of 20 % indicated in fig. 3.4 is just a rough estimate. Transformer overload of 20 % is accepted for 15 min.
- TenneT (NL), being the only TSO to consider bus bar failures without being threatened by their dynamic consequences (cf. section 3.2.2), accept 50 % transformer overload after this type of failure because of the implicit assumption that appropriate countermeasures will be available in such events to relieve overloads of this extent.

TenneT state that due to their peripheral geographical location and the usually high amount of power import, more importance – and less risk of actual overload – is assigned to the tie lines than to internal lines. To avoid subsequent tripping after a tie line failure, no overload is accepted here in contrast to 10 % on internal lines.

- REN (P) reduce tolerated transformer overload from 20 % to 10 % in summer. On the other hand, a further increase of 10 % is accepted for all branches in situations where effective re-dispatch is possible.
- Swiss TSOs/ETRANS allow no overload when determining indicative ETSO NTC, but tolerate 20 % of short-term overload during determination of actually usable capacities.
- GRTN (I) accept up to 20 % of short-term overload as long as corrective measures are available.
- Also Elkraft (DK) accept short-term overloading, taking into account both material softening and distances to earth.

D.1.4 Determination of TRM

Unfortunately, most TSOs estimate their TRM as a whole, so that a quantitative comparison of the individual contributions is not possible. Among those TSOs who base TRM on explicit considerations, a number of different and incompatible approaches can be identified:

- German TSOs determine TRM depending on the number of tie lines. They estimate that all contributions to TRM amount to 100 MW per tie line circuit. Based on the idea that deviations from es-

estimated flows per circuit are stochastically independent, the TRM per border is derived from the number n of interconnection circuits crossing that border by the formula $\text{TRM} = 100 \text{ MW} \cdot \sqrt{n}$.

- TenneT (NL) base their TRM on statistical analysis of observed amounts of inadvertent exchange plus a (small) surplus for uncertainty on system conditions beyond the portion already coped with by explicitly considering different scenarios.
- REE (E) separately calculate the contributions of uncertainty about generation/load/topology (as a fixed percentage of TTC) and about inadvertent exchange (based on statistical analysis). The superposition of these contributions is performed by simply adding them up, which can be regarded a worst case assumption. REE state that TRM on the border to Portugal is dominated by the large sensitivity of capacity with respect to small changes in generation and load distribution. For the French border, REE emphasise the extreme importance for frequency stability of the Iberian peninsula as well as a lack of detailed information about network conditions on the French side. Regarding the latter reason, REE hope to be able to lower TRM as soon as information exchange with RTE (F) has been intensified.
- Svenska Kraftnät (S) state that the level of uncertainty is related to which kind of physical phenomenon is the limiting factor for the capacity across a certain border. When assessing voltage stability, the system's reaction to the fault (e.g. regarding transformer tap changers) is more difficult to predict than in cases where thermal current limits impose the most restrictive limitation. Therefore, TRM is highest in cases of voltage stability limits, lower for static stability and lowest for thermal limits.

D.1.5 Summary of NTC determination principles

In section 3.2 and in the preceding sections of this appendix, the methods and standards applied by the different TSOs to determine the NTC values as published by ETSO have been analysed on a topic by topic basis to point out how individual aspects are treated among TSOs. In order to facilitate an overview how an individual TSO deals with all relevant aspects, the following tables give a brief summary of NTC determination principles. It should however be noted that this compressed information should not be evaluated without consideration of the more detailed explanations in section 3.2 and in the previous sections of this appendix.

		CEGEDEL (L)	CH	D	ELIA (B)	Eltra (DK)	
model	system model	UCTE as is	UCTE as is	UCTE as is + regional models	UCTE as is	own area + vicinity	
	modelling of generation change	internal	not relevant	proportional, subset of generators	proportional	estimated merit order	estimated merit order
		external	not relevant	proportional	proportional	proportional	equivalent
security assessment	regarded (n-1) failures		lines	lines, transformers	lines, transformers, generators	lines, generators	lines, transformers, generators
	regarded (n-2) failures		none	none	none	none	none
	consideration of corrective measures		yes	yes	no	yes	no
	max. conductor temperature		80 °C	80 °C	50-80 °C	75 °C	65-80°C
	ambient temperature	max. value	>40 °C	40 °C	35 °C	25 °C	30 °C
		geographical differentiation	no	no	no	no	no
		time of year differentiation	winter 40 °C	10 °C in winter	no	four seasons	no
		max. current / min. current	[n. a.]	[n. a.]	-	112%	-
	wind speed		[n. a.]	0.5 m/s	0.6 m/s	0.5 m/s	0.6 m/s
	overload in contingency cases	internal line	[n. a.]	0 % / 20 %	0	0	25 %
		tie line	[n. a.]	0 % / 20 %	0	0	25 %
		transformer	[n. a.]	0 % / 20 %	0	0	25 %
ETSO NTC limited by	thermal limits		not relevant	yes	yes	yes	yes
	steady-state voltage		not relevant	no	no	no	no
	voltage stability		not relevant	no	no	no	no
	static stability		not relevant	no	no	no	yes
TRM	contributions		not relevant	uncertainty on generation, load, topology; inadvertent exchange; primary response	uncertainty on generation, load, topology; inadvertent exchange; primary response (partially)	uncertainty on generation, load, topology; inadvertent exchange	primary response, uncertainty on generation, load, inadvertent exchange
	determination		not relevant	estimation as a whole	function of number of tie lines per border	estimation as a whole	no TRM specified; uncertainties considered implicitly in TTC
	amount(s)		not relevant	150 MW	200-350 MW	300	0

Table D.1: Summary of NTC determination principles (table 1 of 3)

		Elkraft (DK)	Fingrid (FIN)	GRTN (I)	NGC (GB)	REE (E)	REN (P)	
model	system model	own area	FIN	UCTE snapshot	GB	UCTE as is	P + E	
	modelling of generation change	internal	actual prod. plans	proportional	estimated merit order	estimated merit order	proportional except nuclear	estimated merit order
		external	-	equivalent	merit order (F), proportional	estimated merit order	proportional	proportional
security assessment	regarded (n-1) failures	lines, generators; rarely bus bars	lines, bus bars, generators	lines, bus bars, transf., generators	lines, transformers, bus bars, generators	lines, transformers, generators	lines, transformers, generators	
	regarded (n-2) failures	rarely double circuit lines	none	double circuit lines	double lines	double lines >30 km, few combinations generator + line	few double lines, combinations line + transformer	
	consideration of corrective measures	yes	no	yes	yes	yes	no	
	max. conductor temperature	various based on forecasts	60-80 °C	70-75 °C	50-90 °C	50-85 °C	50-75 °C	
	ambient temperature	max. value	30 °C	30 °C	no single value	no single value	30 °C	
		geographical differentiation	no	no	no	yes	individually for each line	no
		time of year differentiation	NTC: sum./wint.; alloc.: daily forec.	yes	summer/winter (tie lines only)	five seasons	monthly statistics	15 °C in winter
		max. current / min. current	[n.a.]	-	120-125 %	[n.a.]	120 %	116-148 %
	wind speed	[n.a.]	0.6 m/s	0.6 m/s	no single value	0.6 m/s	0.6 m/s	
	overload in contingency cases	internal line	yes	0	120%	19-79 %	15 %	20-30 %
		tie line	yes	0	120%	only HVDC	0	20-30 %
transformer		yes	0	120%	19-79 %	10 % (n-2: 10-20 %)	10-30 %	
ETSO NTC limited by	thermal limits	yes	yes	yes	yes*	yes	yes	
	steady-state voltage	no	no	no	yes*	yes	no	
	voltage stability	yes	yes	no	rarely*	no	no	
	static stability	yes	yes	no	rarely*	no	no	
TRM	contributions	inadvertent exchange, regulating power	uncertainty on generation and load	inadvertent exchange, emergency exchange, common reserve	not relevant	uncertainty on generation, load, topology; inadvertent exchange	inadvertent exchange	
	determination	individual for the two contributions	estimation as a whole	statistics, reserve contracts	not relevant	separate determination of the two contributions; worst case superposition	estimation as a whole	
	amount(s)	200 MW	100 MW	500-600 MW	not relevant	300-400 MW	50 MW	

Table D.2: Summary of NTC determination principles (table 2 of 3)
 *: NGC limitations related to internal transmission capacity rather than ETSO NTC

		RTE (F)	Statnett (N)	Svenska K. (S)	TenneT (NL)	TIWAG (A)	Verbund APG (A)	
model	system model	UCTE updated	NORDEL	NORDEL	UCTE as is	UCTE + 110 kV links	UCTE as is	
	modelling of generation change	internal	estimated merit order	proportional to base case or start/stop of generators	proportional in worst case regions	proportional	not relevant	proportional
		external	proportional	proportional load or generation adjustment	proportional in worst case regions	proportional in 3 regions (scenarios)	not relevant	proportional
security assessment	regarded (n-1) failures	lines	lines, transformers, generators, some bus bars	lines, transformers, bus bars, generators	lines, transformers, bus bars, generators	lines, transformers	lines, transformers	
	regarded (n-2) failures	few double lines	none	none	none	none	none	
	consideration of corrective measures	yes	yes	yes	no	yes	no	
	max. conductor temperature	75-90 °C	50-100 °C	50-80 °C	70 °C	80 °C	80 °C	
	ambient temperature	max. value	no single value	20 °C	no single value	30 °C	35 °C	35 °C
		geographical differentiation	3 regions	no	yes	no	no	no
		time of year differentiation	five seasons (down to 5 °C)	NTC: summer/winter; allocation: daily forecast	NTC: sum./wint.; alloc.: daily forecast	no	+20 % in winter	no
		max. current / min. current	130 %	[n. a.]	[n. a.]	-	120 %	-
	wind speed	0.5 m/s	0.6 m/s	0.6 m/s	0.6 m/s	0.6 m/s	0.6 m/s	
	overload in contingency cases	internal line	15-25 %	0-20 %	20 °C	10 %	0	0
		tie line	15-25 %	0-20 %	20 °C	0	0	0
transformer		not considered	0-40 %	20 % for 15 min	10-50 %	10 %	0	
ETSO NTC limited by	thermal limits	yes	yes	yes	yes	not relevant	yes	
	steady-state voltage	no	no	no	no	not relevant	no	
	voltage stability	rarely	yes	yes	no	not relevant	no	
	static stability	no	yes	yes	no	not relevant	no	
TRM	contributions	observed fluctuations and uncertainties	regulation band	uncertainty on generation, load, topology; inadvertent exchange	uncertainty on generation, load, topology; inadvertent exchange	not relevant	uncertainty on generation and load; inadvertent exchange; primary	
	determination	estimation as a whole	estimation as a whole	depending on limiting phenomenon	statistical analysis for inadvertent exchange + surplus for other uncertainties	not relevant	estimation as a whole	
	amount(s)	200-300 MW	150 MW	150-300 MW	300 MW	not relevant	[n. a.]	

Table D.3: Summary of NTC determination principles (table 3 of 3)

D.2 Methods for allocation of cross-border capacity and determination of allocable capacity

For a number of reasons, the methods applied for determining allocable, i.e. binding capacity figures deviate from those used for the calculation of ETSO NTC. In this section, for those borders where actual congestion occurs, such deviations are described along with a brief introduction of the respective allocation methods.

D.2.1 Portugal ↔ Spain

Allocation method

Capacity allocation for this border is performed via the Spanish day-ahead market auction where REN (P) is an authorised “external agent”. Available cross-border capacity is first divided among the total of pool bids and the total of physical bilateral contracts according to their respective cumulatively requested volumes. In a second step, the capacity share for pool bids is assigned to the market according to the merit order, whereas for bilateral contracts an explicit auction for transmission rights is held.

Capacity determination

Capacity figures are determined individually by REN (P) and REE (E), the minimum result being retained for allocation.

In principle, **REN (P)** determine allocable capacities similarly to ETSO NTC, with the following differences:

- Allocable capacity is determined once a week for each hour of the following two weeks.
- The calculation is based on archived real, i.e. actually observed systems states from REN’s state estimator. This model reflects the current situation of the Portuguese transmission network; on the other hand, congestion in the Spanish network cannot be detected. Therefore, calculation results are compared to the values obtained by REE (E), and the lower values are retained. (For ETSO NTC determination, a system model of the whole Iberian peninsula is used.)
- In contrast to the determination of ETSO NTC where REN study eight different scenarios and perform a worst case estimation on the resulting capacity, allocable capacity is calculated on the basis of only one network situation, thereby taking into account the better knowledge of actual system conditions at the time of calculation.

- Since the Spanish network is represented by an equivalent, generation increase or decrease in the REE area is modelled by adjusting the equivalent instead of proportional distribution among actual generators.
- Corrective measures to relieve congestion are taken into consideration (this is not the case for ETSO NTC calculation).

REE (E) apply the following modifications compared to their ETSO NTC determination:

- Allocable capacity is determined once a week for a two-week horizon (daily values for peak and off-peak capacity). The results are reviewed daily and amended if necessary.
- A network model is used which is more up-to-date than the common UCTE model, but geographically restricted to the own area, foreign network parts being represented by an equivalent. (For ETSO NTC assessment, the common UTCE model is used.)
- Consequently, generation changes in foreign areas are modelled by adjusting the equivalent instead of proportional distribution among actual generators.
- Thermal current ratings for overhead lines are differentiated on a three-monthly basis.

D.2.2 France ↔ Spain

Allocation method

So far, allocation of capacity between Spain and France is handled individually by RTE (F) and REE (E), thus requiring market players to obtain capacity from both TSOs. On the Spanish side, allocation is done via the day-ahead market auction as described in section D.2.1 about the Spanish-Portuguese border. RTE have not published an allocation procedure. In fact, capacity is allocated on a first-come-first-served basis with prioritisation of long-term contracts from the pre-liberalised era. (REE and RTE are currently planning to introduce a harmonised auction-based allocation scheme.)

Capacity determination

REE (E) calculate allocable capacity in the same way as for the Spanish-Portuguese border discussed in section D.2.1.

In principle, **RTE (F)** use the same methodology as for the determination of ETSO NTC, with the following differences:

- A monthly, weekly and daily recalculation of the capacity is performed to reflect changes of system conditions.
- Regarding ambient temperatures used to determine thermal line current limits, five different seasons are considered instead of two for ETSO NTC calculation.

D.2.3 France ↔ Great Britain

Allocation method

Transmission capacity for the DC link between France and Great Britain is allocated by a joint auctioning procedure executed by RTE (F) and NGC (UK). From France to Great Britain, tri-annual contracts (obtained after a call for tender) as well as annual and daily auctions are available. Capacity for the reverse direction is exclusively allocated by means of yearly and daily auctions.

Capacity determination

Both RTE and NGC state that transmission capacity on this border is usually only limited by the DC link itself. Therefore, the rating of the link is used as allocable capacity without applying special network calculation methods.

If in the NGC grid – e.g. during outages in the vicinity of the interconnection – the actual capacity is reduced below the DC link's rating, this congestion is resolved by means of counter trades, which is the same method that is applied for internal congestion.

D.2.4 France ↔ Belgium

Allocation method

So far, market players have to obtain capacity from both adjacent TSOs, RTE (F) and ELIA (B). In the case of RTE, there is no published allocation method. ELIA allocate capacity according to a modified²

² Details can be found at www.elia.be

first-come-first-served scheme on a monthly basis, but with prioritisation of long-term contracts from the pre-liberalised era.

Capacity determination

RTE (F) determine the capacity to and from Belgium in the same way as for the border between France and Spain as described in section D.2.2.

In principle, ELIA (B) use the same methodology as for the determination of ETSO NTC, with the following differences:

- The load flow model is updated, e.g. by using recent DACF data to reflect changes in foreign networks.
- A regular recalculation of the capacity is performed to reflect changes of system conditions.
- Regarding ambient temperatures used to determine thermal line current limits, four different seasons are considered instead of two for ETSO NTC calculation.

D.2.5 France ↔ Germany

The allocation method for transmission capacity over this border is discussed along with the considerations on the severity of congestion in appendix E.6.

D.2.6 Netherlands ↔ Belgium/Germany

Allocation method

TenneT (NL) and the three adjacent TSOs have harmonised the method for allocation of capacity for transports to and from the Netherlands. The mutually agreed overall import/export capacity is first reduced by the volume of long-term contracts from the pre-liberalised era, then distributed among the three borders according to fixed percentages and finally allocated by six individual auctions (E.ON Netz (D) → TenneT, RWE Net (D) → TenneT, ELIA (B) → TenneT and the respective reverse directions) for three different time horizons (yearly, monthly, daily).

Capacity determination

The ETSO NTC value for import to the TenneT area, multiplied with the fixed percentage corresponding to each border, constitutes the maximum allocable capacity per border. Additionally, each

TSO performs short-term capacity calculations which are presently triggered by approaching events like line maintenance, for example. (It is planned to extend this procedure to a regular daily capacity determination for every hour of the following day.) For these short-term assessments, all involved TSOs apply the same methods and standards than for determination of the ETSO NTC. However, results of short-term calculations may only be used for a reduction, not an increase of the initial capacity values.

D.2.7 Germany ↔ Denmark

Allocation method

The transmission capacity across the Danish-German border is jointly administered by E.ON Netz (D) and Eltra (DK). It is allocated by means of yearly, monthly and daily auctions for both transfer directions.

Capacity determination

Because of the limited geographical extension of the border and the negligible influence of flows induced by third parties both E.ON Netz and Eltra state that transmission capacity is well predictable. Therefore, the ETSO NTC is used for allocation most of the time.

D.2.8 Germany ↔ Sweden

Allocation method

Currently, there is no published allocation method for the “Baltic Cable” DC link between the networks of Svenska Kraftnät (S) and E.ON Netz (D). The cable is operated by the investors Sydkraft, Vattenfall and E.ON Energie.

Capacity determination

The usable capacity of this interconnection is equal to the ETSO NTC values. Since the German terminal is not linked to the 380 kV network yet, E.ON Netz take into account a model of the regional 110 kV network instead of the common UCTE 380/220 kV model.

D.2.9 France/Switzerland/Austria ↔ Italy

Allocation method

Presently, allocation of cross-border capacity for the Italian border is not harmonised. Instead, for each border between the areas of GRTN (I) and one of the adjacent TSOs, 50 % of the available capacity are allocated by GRTN and 50 % by the respective neighbouring TSO or country.

Since the allocation rules for 2001 are not considered a final solution, the method will probably change for the next year(s). So far (as of October 2001), there is however no reliable information on the allocation method for 2002. (Market participants complain about this delayed information as a lack of transparency.) The following information is related to the allocation for 2001.

RTE (F) allocate capacity from France to Italy on a pro rata basis with a prioritisation to long-term contracts from the pre-liberalised era. The standard allocation period is one year, but unused capacity may be returned for re-allocation on a daily basis.

Verbund APG (A), following Austrian legislation, allocate their share of the capacity on a first-come-first-served basis.

GRTN (I) had started to auction off the transmission rights, but the auction was stopped by a trial. The actual allocation was then performed on a pro-rata basis.

In **Switzerland**, there is no official allocation of transmission rights, because network operation is not unbundled from generation yet.

Capacity determination

In principle, **RTE (F)** apply the same methods and standards as for the determination of ETSO NTC. A particularity of the French-Italian capacity is that it is based on an additional risk assessment: The allocable amount of capacity is a constant value published for the whole year in advance (with the exception of a two-week maintenance period). Technically, this capacity may not be available at all times. In these cases, RTE perform a generation re-dispatch inside France. The costs associated with this are covered in advance by an additional charge which is imposed on the allocated cross-border capacity. RTE state that this procedure suits the needs of the market players who wish to acquire transport capacity which is as large as possible and at the same time available practically constantly throughout the year.

In 2001, a working group has been formed by **RTE**, **Swiss TSOs/ETRANS** and **GRTN (I)** who now jointly calculate the cross-border transmission capacities between the respective countries. These capacities are planned to be used for allocation in the future. In principle, all members apply the same methods and standard as for the determination of ETSO NTC, with the following exceptions:

- A common system model is used by all participants which is based on the common UCTE snapshots, but jointly modified to better reflect a representative base case.
- Swiss TSOs/ETRANS tolerate short-term overloading of network branches by 20 % (and higher in particular cases), whereas no overload is accepted for ETSO NTC determination.

Verbund APG (A) regard capacity allocation completely separated from ETSO NTC determination. While the latter is based on network calculation considering the meshed grid, the former is performed with respect to a UCTE rule which limits bilateral allocable capacity to the sum of thermal ratings of all direct interconnection lines [2]. In principle, this rule is valid for all UCTE borders, but the Austrian-Italian interconnection is the only one in Europe where it is more restrictive than a load flow based assessment. The reason for this phenomenon is the specific local network topology. At most borders, the inhomogeneous loading of lines as well as network security criteria cause the transmission capacity to be considerably smaller than the sum of the individual tie line ratings. In contrast, at the Austrian-Italian border there is only one 220 kV tie line so that a power exchange between the two countries would mainly flow over low impedance connections via the neighbouring networks of Switzerland and Slovenia. Therefore, even under consideration of contingency cases, the feasible power exchange would exceed the thermal rating of the direct interconnection and thus the upper bound set by the UCTE rule.

D.2.10 Borders inside the NORDEL interconnection

Allocation method

Restrictions on transmission between (and in Norway also inside) the Nordic TSOs' networks are managed through the method of "market splitting". Between pre-defined network areas, bilateral transmission capacities are determined daily for every hour of the following day. Reflecting the sparsely meshed structure of the NORDEL grid, these areas coincide with the individual TSOs' areas of responsibility, with the exception of the Statnett (N) grid being divided into three areas.

All bids for demand and supply (including bilateral cross-border transactions) are handled by Nord Pool, the Nordic electricity market. If an unconstrained matching of the bids results in area balances (export or import) that would lead to an inter-area exchange in excess of the given capacities, match-

ing is redone with constrained area balances, thereby replacing the system-wide clearing price by a set of individual area prices.

Capacity determination

At least Fingrid (FIN) and Svenska Kraftnät (S) apply the same methods and standards for the calculation of allocable capacity as for ETSO NTC assessment, but perform a daily recalculation taking into account further knowledge on system conditions, line outages etc. For Svenska Kraftnät this implies – for those borders where a set of scenarios needs to be considered – the selection of the scenario which for the given time frame actually accounts for the critical limitation of transmission capacity (cf. discussion on uncertainties on page 28).

E Individual analysis of cross-border transmission congestion

E.1 Overview

The TSOs as well as market actors have stated that congestion occurs at least occasionally at almost every European border. In this chapter, for each of these borders the existing interconnections as well as the reasons for congestion will be further analysed. Besides, the severity of the congestion will be discussed in order to make the selection of the most critical borders (cf. chapter 4) transparent which have been in the focus of the second phase of the study.

In the following sections, data on tie line capacity between countries of UCTE members is taken from the UCTE load flow forecast data as of January 2001 as provided to us by ETSO (cf. appendix I.1) and refers to thermal current ratings. Additional limitations according to the UCTE Statistical Yearbook 2000 [12] are mentioned where applicable. Current ratings for the Italian tie lines have been provided by GRTN (I) and reflect recent negotiations between GRTN, RTE (F) and Swiss TSOs. In contrast to the UCTE figures, the capacity figures for NORDEL interconnections based on [3] are not necessarily related to thermal current limits, but rather represent the results of the TSOs' assessment of transfer capacity per interconnection (comprising one or more lines).

It should be noted that the individual line ratings or any sum of them must not be mixed up with the transmission capacity between two adjacent countries, because such simplified consideration would not take into account a number of limiting factors like security margins, parallel flows, margins for reactive power transport (as far as values are given in MVA) and the “natural” power flow distribution in AC transmission systems.

E.2 Portugal ↔ Spain

Existing interconnections

The network of REN (P) is connected to the Spanish network by two 380 kV circuits (one in the north-west and one in the centre) and three 220 kV circuits in the north-east (table E.1).

tie lines Portugal ↔ Spain	U_N [kV]	capacity [MVA]
Alto Lindoso ↔ Cartelle	380	1260
Bemposta ↔ Aldeadavila	220	340
Pocinho ↔ Aldeadavila	220	340
Pocinho ↔ Saucelle	220	340
Pego ↔ Cedillo	380	750

Table E.1: Tie line capacity on Portuguese-Spanish border

Situation leading to congestion

The load flow distribution on the Iberian peninsula is strongly influenced by the availability of hydraulic generation. Depending on the voltage level, congestion occurs for different reasons:

- In the 380 kV level, the coincidence of three conditions is necessary for congestion. First, a surplus of hydraulic generation in north-western Spain together with the load concentration in the Madrid area induce a strong parallel flow through the Portuguese network. Second, the distribution of generation and load inside Portugal may further increase this parallel flow. Finally, generation units in western Spain (installed capacity of 1700 MW) inject power at the Cedillo and Oriol substations, i.e. at the Spanish terminal of the southern 380 kV tie line (Pego-Cedillo) from Portugal.

These three influences lead to a high loading of the Oriol-Aranuelo double circuit line, i.e. the continuation of the Pego-Cedillo tie line towards central Spain. The critical contingency is the failure of one of these circuits leading to thermal overload of the parallel system.

- Peak output of generation units connected to the northern Portugal 220 kV grid of northern Portugal normally exacerbates the load flow situation of the 380 kV network. To avoid this, these generators are sometimes operated in directional mode, i.e. they are – via the 220 kV tie lines – only connected to the Spanish system. However, regional generation must then be limited to the capacity of the 220 kV tie lines (under consideration of security criteria). Again, thermal overload is the dimensioning phenomenon.

Severity of congestion

According to similar statements from REE and REN, congestion on this border is an occasional, non permanent event mostly related to specific hydraulic generation patterns.

E.3 France ↔ Spain

Existing interconnections

The Iberian peninsula is connected to the French network by two 380 kV lines in the western and eastern part of the border, respectively, and two 220 kV lines in the western and central part of the border (table E.2). The power flow on the central 220 kV interconnection Pragnères-Biescas is controllable by means of a phase shifting transformer in Pragnères.

tie-lines Spain ↔ France	U_N [kV]	capacity [MVA]
Arkale ↔ Mouguerre	220	420
Hernani ↔ Cantegrit	380	1270
Biescas ↔ Pragnères	220	330
Vic ↔ Baixas	380	1650

Table E.2: Tie line capacity on Spanish-French border

Situation leading to congestion

Most of the year, there is a strong demand for import from France (and the rest of UCTE) to Spain. However, depending on the availability of hydraulic power from the Pyrenees, there are also periods of power export, mostly during winter.

Regarding the western part of the border, **import to Spain** is affected by a parallel flow phenomenon: Even when the Spanish system is importing and a significant southbound power flow is taking place on the 380 kV line Cantegrit-Hernani, the almost parallel 220 kV line Arkale-Mouguerre is loaded in northbound direction. (This means that the load in south-western France is “electrically closer” to Spain than to the domestic network.) Therefore, this line does practically not contribute to import capacity today.

According to REE (E), the effects which actually limit cross-border capacity are different for peak and off-peak hours:

- During peak hours, the dimensioning incident is the outage of a nuclear power plant in north-eastern Spain. Due to the subsequent lack of local reactive power support as well as the foreign contribution to primary response leading to temporarily increased import flow, voltage at the Spanish end of the eastern 380 kV interconnection (Vic substation) drops beyond its lower limit.

(RTE (F) state thermal current as the limiting phenomenon regardless of the load situation. This is however not a contradiction because outages of Spanish generators are not considered by RTE.)

- In off-peak periods with lower load, the voltage profile is less critical. Here, thermal currents become the limiting phenomenon: A failure of the eastern tie line Baixas-Vic leads to a violation of the current limit for the second 380 kV line Cantegrit-Hernani. (The central 220 kV line Pragnères-Biescas, although being closer to the tripped line, is prevented from overload because of the phase shifting transformer in Pragnères.)

According to REE (E), **export to France** is usually limited by the thermal ratings of internal Spanish lines. Additionally, RTE (F) report occasional problems with voltage stability.

Severity of congestion

Market players as well as the TSOs state that the Spanish-French border is, at least in the direction from France to Spain, permanently congested. In recent years, power transfer from France to Spain has constantly increased, with the exception of some winter months where also exports from Spain have taken place (fig. E.1). The peak of 800 GWh monthly imported energy in the autumn of 2000 illustrates the severity of the congestion: Even under the favourable assumption of a constant import flow, the corresponding average power import would amount to $800 \text{ GWh} / 730 \text{ h} = 1100 \text{ MW}$, which is equal to the ETSO NTC value. Although actually allocable capacity is somewhat higher because of seasonal (RTE) or monthly (REE) adaptation of current limits, the interconnection must have been fully utilised almost all of the time to make this energy transfer possible.

In contrast to this, power transfer from Spain to France is only occasionally limited by congestion, mostly during winter.

monthly energy exchange

Fig. E.1: Monthly electricity exchange between Spain and France in the last 5 years
(source: <http://www.ree.es>)

E.4 France ↔ Great Britain

Existing interconnections

The transmission networks of RTE (F) and NGC (UK) are connected by a DC link with a capacity of 2000 MW in both directions.

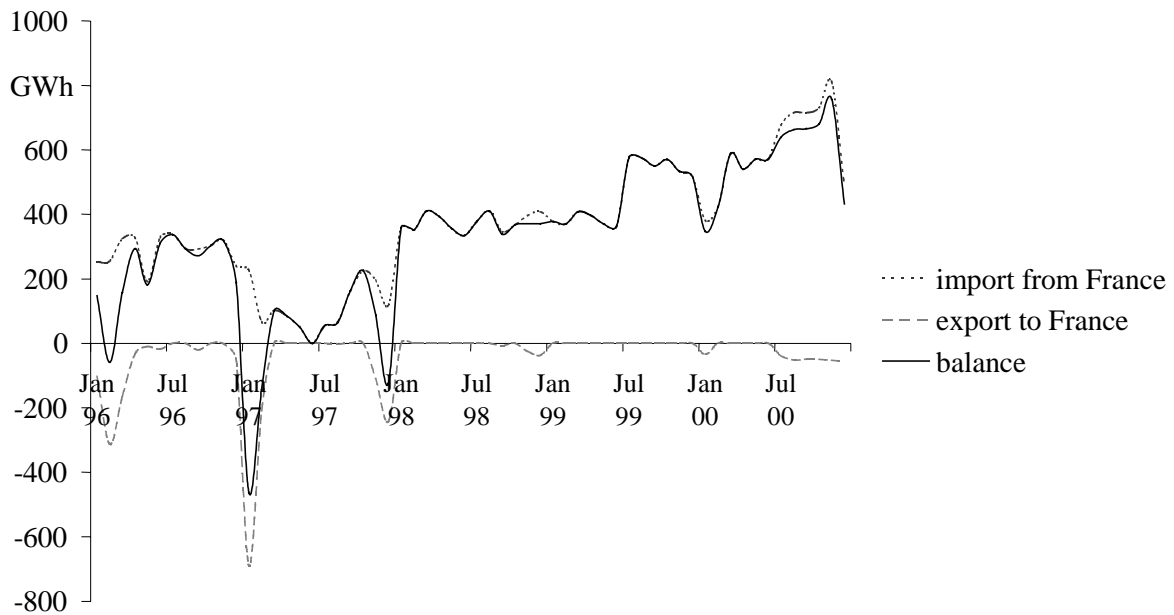
Situation leading to congestion

Both adjacent TSOs state that the amount of cross-border transfer is only limited by the rating of the DC link itself. Neither on the French nor on the British side there are further restrictions technically limiting usable capacity.

Severity of congestion

The DC link is usually fully utilised in the direction from France to Great Britain. The results of the auctions published by RTE (<http://www.rte-france.com>) indicate an almost permanently congested situation.

E.5 France ↔ Belgium

Existing interconnections

The transmission networks of France and Belgium are connected by two 220 kV and two 380 kV circuits (table E.3). The capacity of the 220 kV line Chooz-Jamiolle is slightly restricted (290 instead of 322 MVA) by a 220/150 kV transformer in Jamiolle.

tie lines France ↔ Belgium	U_N [kV]	capacity [MVA]
Chooz ↔ Jamiolle	220	290*
Lonny ↔ Achene	380	1490
Avelin ↔ Avelgem	380	1350
Moulaine ↔ Aubange	220	330

Table E.3: Tie line capacity on French-Belgian border

(* : limited by 220/150 kV transformer in Jamiolle, on 150 kV side)

Situation leading to congestion

Long-term contracts between France and Belgium from the pre-liberalised era as well as transit to the Netherlands cause a predominant load flow in northbound direction. Because of the high degree of meshing, the French-Belgian border must be assessed in conjunction with the northernmost French-German (double circuit) tie line Vigy-Uchtelfangen. Power transfer is limited by thermal current ratings which are reached when either one of the French-Belgian 380 kV lines or one of the Vigy-Uchtelfangen circuits fails.

Severity of congestion

Since most capacity on this border is still assigned to long-term contracts, and since no statistical data on network usage exists, there is no objective information on the degree of congestion. However, a representative of a large industrial consumer has reported great difficulties in getting cross-border access from France to Belgium, in this case to supply a plant in the Netherlands. Moreover, we could draw conclusions from the results of the Belgian-Dutch auction which indirectly justify the assumption that the French-Belgian border is significantly congested (cf. section E.7 below).

E.6 France ↔ Germany

Existing interconnections

France and Germany are connected by four tie line circuits, three of which are in the 380 kV grid (table E.4).

tie lines France ↔ Germany	U_N [kV]	capacity [MVA]
Vigy ↔ Uchtelfangen (RWE Net)	380	1170
Vigy ↔ Uchtelfangen (RWE Net)	380	1170
Muhlbach ↔ Eichstetten (EnBW)	380	1790
Vogelgrun ↔ Eichstetten (EnBW)	220	470

Table E.4: Tie line capacity on French-German border

Situation leading to congestion

The double circuit tie line to RWE Net is the most critical one because it is close to the large French nuclear power plant of Cattenom and at the same time important for power transmission from entire France to Germany as well as to Belgium and the Netherlands.

Severity of congestion

We have been informed by a market participant that transmission from France to RWE Net is sometimes refused during the summer months. According to explanations given to us by RTE (F), this problem however seems to be caused by the particularities of the prevailing access regime for capacity across this border rather than by a severe lack of capacity. Apparently, costs of re-dispatch in case of congestion are only allocated to those actors whose requests actually lead to an excess of transmission demand for a given point in time, and not to those who are “first” allocated the available capacity on the basis of priority rules. Therefore, even if congestion is relatively seldom at this location (which is true as far as we are informed), it can imply significant costs for a small number of affected actors. To our mind, this problem can be solved by introducing more appropriate access regulations for this interconnection without the urgent need to increase available capacity. We therefore do not consider this case, i.e. transmission from France to Germany, a relevant bottleneck for the further investigation within this study. However, the tie line from Vigy to Uchtelfangen needs to be considered in the context of the French-Belgian border (cf. section E.5).

E.7 Netherlands ↔ Belgium/Germany

Existing interconnections

The Dutch network is connected to the networks of Belgium and Germany by ten tie line circuits with an overall capacity of ca. 11.6 MVA (table E.5). On the lines between Gronau and Hengelo, power flow is controllable by a phase shifting transformer installed at Gronau (which on the other hand limits the maximum flow on these tie lines to a value far below the mere line capacities). The transmission capacity of the connection Zandvliet-Borssele is significantly restricted by a transformer in Borssele.

tie lines Germany/Belgium ↔ Netherlands		U_N [kV]	capacity [MVA]
D ↔ NL	Conneforde ↔ Meeden	380	1320
	Diele ↔ Meeden	380	1320
	Gronau ↔ Hengelo	380	1300*
	Gronau ↔ Hengelo	380	
	Rommerskirchen ↔ Maasbracht	380	1580
	Siersdorf ↔ Maasbracht	380	1580
B ↔ NL	Zandvliet ↔ Borssele	380	450**
	Zandvliet ↔ Geertruidenberg	380	1476
	Meerhout ↔ Maasbracht	380	1320
	Lixhe ↔ Maasbracht	380	1320

Table E.5: Tie line capacity on German/Belgian-Dutch borders

(*: capacity restricted by phase shifting transformer in Gronau;

** : capacity restricted by transformer in Borssele)

Despite the large amount of tie line capacity, allocable capacity is much lower (≤ 3600 MW including currently 1500 MW of long-term contracts from the pre-liberalised era). Among the reasons for this are generally applicable aspects like reactive power transfer, load flow based security criteria and the TRM. However, the largest part of the theoretical capacity remains unused because of the inhomogeneous load flow distribution and its sensitivity with respect to the locations of physical power sources and sinks which are not known at allocation time.

Consequently, the uncertainty on the inter-area load flow distribution is taken into account by TenneT (NL) by means of a rather prudent scenario analysis (cf. p. 28).

Situation leading to congestion

Since the Netherlands are currently a high price area, there is a strong demand for import to the TenneT system. (However, TenneT state that due to changing national regulations, a shift towards a more transit dominated situation could take place.) The dimensioning situation for import capacity is the violation of thermal current limits after a line outage. Due to the variability of the load flows in this region, no specific bottleneck can be identified. However, according to TenneT the Dutch grid is usually not critical; ELIA (B) state that the Belgian-Dutch border is not critical either; and RWE (D) report that there is usually no congestion in their internal grid area. Consequently, overload probably occurs either on the French-Belgian tie lines or inside Belgium (note that France is the power source in one of the assessed scenarios), on the German-Dutch tie lines or inside the E.ON Netz (D) grid.

TenneT state that occasionally, steady-state voltages inside their system become the critical factor. (This concern could become even more important if power import was further increased and should therefore be taken into account when assessing measures to increase capacity.)

Severity of congestion

We have analysed the frequency of congestion by evaluating data on the results of the six day-ahead auctions (three neighbours of TenneT, two directions each) available from TSO Auction b. v. (<http://www.tso-auction.org>). Since the *nominated*, i.e. actually used capacity is not published, the analysis had to be restricted to the *auctioned* capacity. Because the “use-it-or-lose-it” principle is applied, usually all offered capacity is auctioned in both import and export directions. However, the achieved clearing price can serve as a criterion to decide if there was actually a congested situation. For the following analyses, we have applied a price threshold of 0.1 Euro/MWh below which we assume the “congestion” to be negligible. (Anyway, this threshold has no significant impact on the results, because in most cases a clear distinction between “congestion” and “no congestion” could be made.)

An exemplary evaluation has been carried out for the month of February 2001 (fig. E.2). For every hour of day, the number of days has been counted at which congestion has occurred during the respective hour. For both RWE Net (D) and E.ON Netz (D), this is the case practically every day between 8 a.m. and 8-9 p.m.

During the same period, the border between ELIA and TenneT has been congested on only one day. Market participants state that this is probably because of congestion at the French-Belgian border blocking transit flows from France before they “reach” the Dutch border.

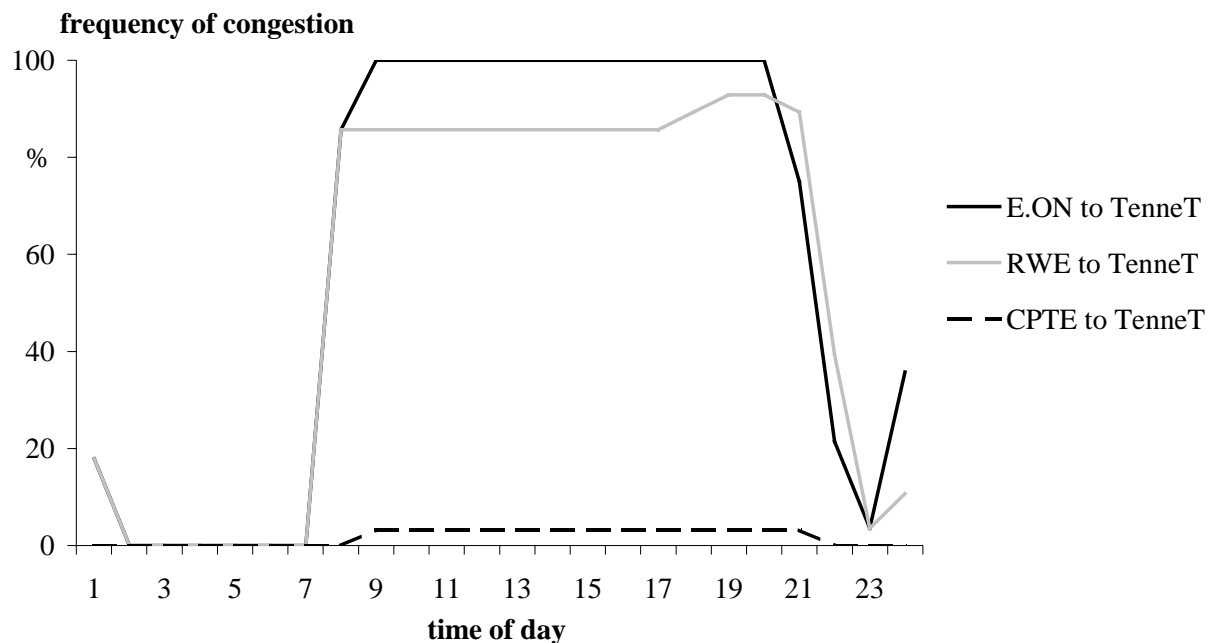

Fig. E.2: Frequency of congestion from Belgium and Germany to the Netherlands in February 2001

An extension from the previously regarded single month to a three months period (shown in fig. E.3 for E.ON Netz to TenneT transfer) reveals no significant differences in congestion frequency. (In January 2001 the present auction scheme has started which may explain the slightly different results in that month.)

A difference between congestion on workdays and during week-ends could not be found either (fig. E.4). Summarising, the analysis underlines that the Dutch border is congested practically every day during day hours.

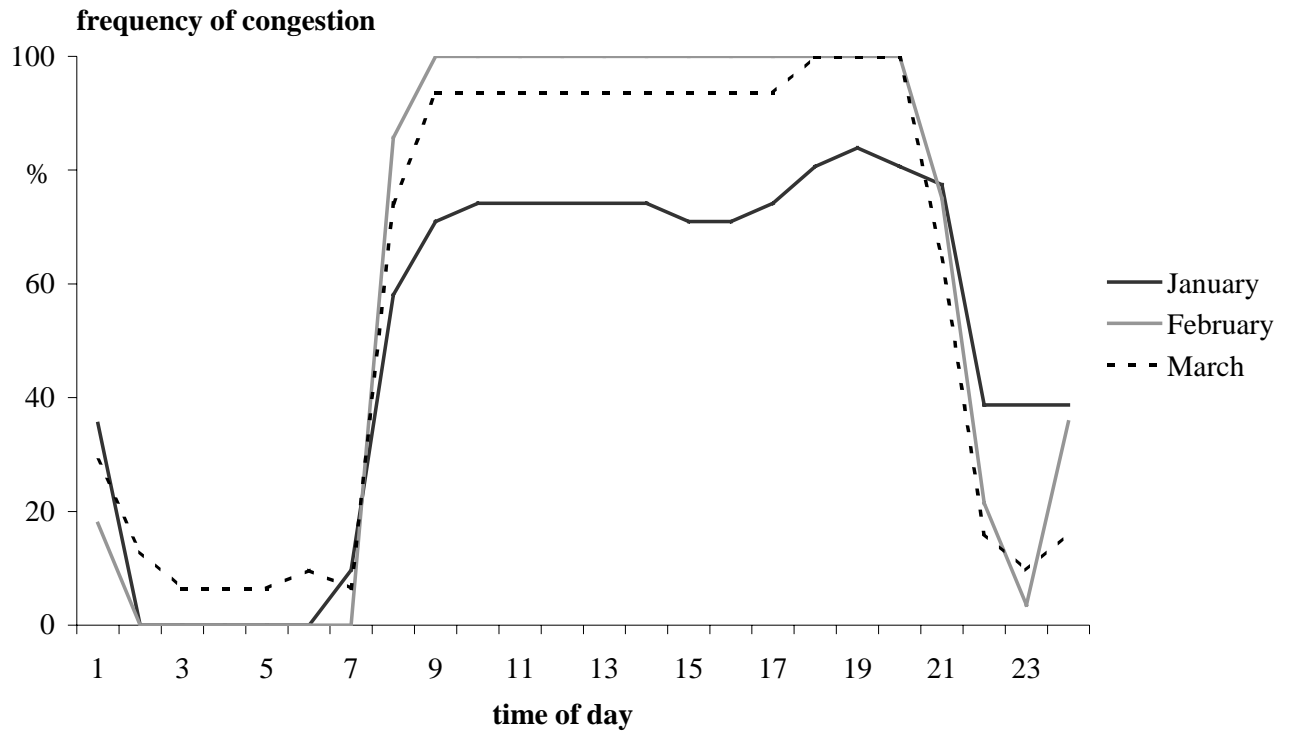

Fig. E.3: Frequency of congestion from E.ON Netz to TenneT in first quarter of 2001

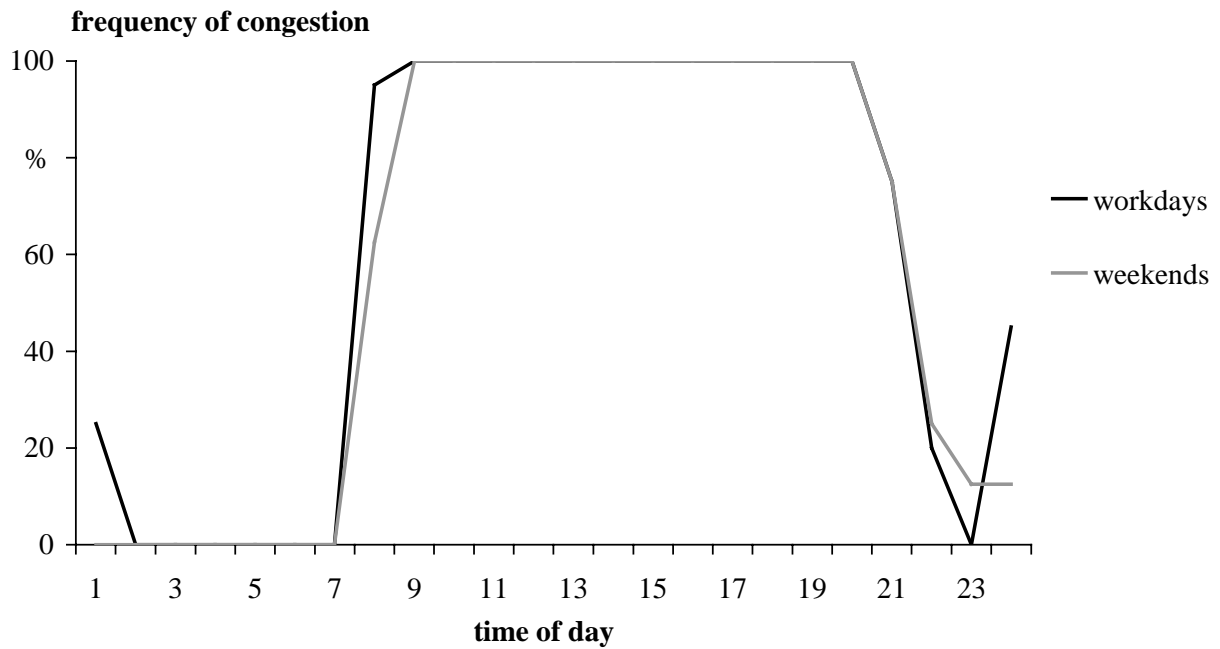

Fig. E.4: Frequency of congestion from E.ON to TenneT: comparison between workdays and weekends in February 2001

E.8 Germany ↔ Denmark

Existing interconnections

The German network is linked to the eastern Danish (Elkraft) network by means of a 600 MW DC link and to the western Danish (Eltra) system by four AC tie lines (table E.6). The transmission capacity of the 220 kV tie lines is additionally restricted by transformers, although only by 30 MVA each.

tie lines Denmark ↔ Germany	U_N [kV]	capacity [MVA]
(west) Kasso ↔ Audorf	380	830
(west) Kasso ↔ Audorf	380	830
(west) Aabenraa ↔ Flensburg	220	300*
(west) Aabenraa ↔ Flensburg	220	300*
(east) Bjæverskov ↔ Bentwisch	DC 400	600

Table E.6: Tie line capacity on Danish-German border

(*: capacity restricted by transformer)

Situation leading to congestion

In recent years, both Denmark and (especially northern) Germany have been facing a strong increase of installed wind generation capacity. The uncontrollable amount of actual wind generation can lead to a local power surplus and, in case this happens in Denmark, southbound export to Germany. Additionally, the Eltra system serves – via its DC interconnections – as a transit platform between Germany and Norway/Sweden. Consequently, congestion on this border may occur in both directions.

Regarding power transport in **southbound** direction, capacity is limited to 1200 MW (1235 MW minus 35 MW for primary control) by static stability problems that have been observed by Eltra (DK) some years ago. If stability was not critical, transmission capacity could – according to Eltra – be raised to 1400 MW, set by thermal limits. (We do however not know if this increase would be impeded by internal restrictions in the E.ON Netz (D) network.) In order to improve static stability, Eltra has in the meantime installed power systems stabilisers (PSS). However, the transmission capacity has remained constant, because no new stability studies have been carried out so far.

Allocable transmission capacity in **northbound** direction amounts to 800 MW which is significantly lower than the southbound value. As regards the reason for this, different explanations have been provided by E.ON Netz and Eltra:

- According to E.ON Netz, a margin in the magnitude of a few hundred MW is assigned to the transport of reserve power in case of a generator outage in southern Denmark.
- According to Eltra, the outage of the internal Danish 380 kV line Tjele-Kassø leads to a violation of thermal current limits in the 150 kV grid between Kassø and Landerupgard.

The amount of cross-border power transfer via the DC connection is only limited by the DC link itself; there are no restrictions in the adjacent AC networks.

Severity of congestion

Regarding the utilisation of the DC link, no information is available that allows for an evaluation of the severity of eventual congestion. Therefore, the following analysis is related to the AC connections only.

In order to assess the frequency of congestion, we have analysed statistical data on the day-ahead auction results from October 2000 to February 2001 available at <http://www.eon-netz.com>. Similarly to the Belgian/German-Dutch border (section E.6) a clearing price above 0.1 Euro/MWh has been used as an indicator for congestion.

During the regarded period, congestion for the southbound direction has occurred every month, while the northbound direction was affected only in October 2000 and February 2001. The evaluation for October 2000 shows that from Denmark to Germany, congestion is restricted to day hours (9 a.m. to 8 p.m.), whereas in the reverse direction congestion occurs at all hours of day, but with an emphasis on night hours (fig. E.5). Another result is that within the same month, there can be congestion during day hours in both directions (although not at the same days). This underlines the short-term influence of wind generation leading to highly variable regional load flow conditions.

The restriction of the southbound congestion to day hours can also be verified for the other analysed months (fig. E.6). Besides, a certain variation of congestion frequency can be identified, but without a distinctive seasonal correlation. Regarding the reverse direction (Germany to Denmark), congestion is generally less frequent and less concentrated on peak hours (fig. E.7).

Different from, for example, the Belgian/German-Dutch border, the German-Danish one is – at least in the more severely congested southbound direction – mainly affected on workdays (fig. E.8). In contrast, transmission from Germany to Denmark is more frequently congested during weekends.

Summarising, the analysis shows that this border is affected by severe congestion due to a superposition of causes. The ongoing increase in wind generation will probably further exacerbate this situation.

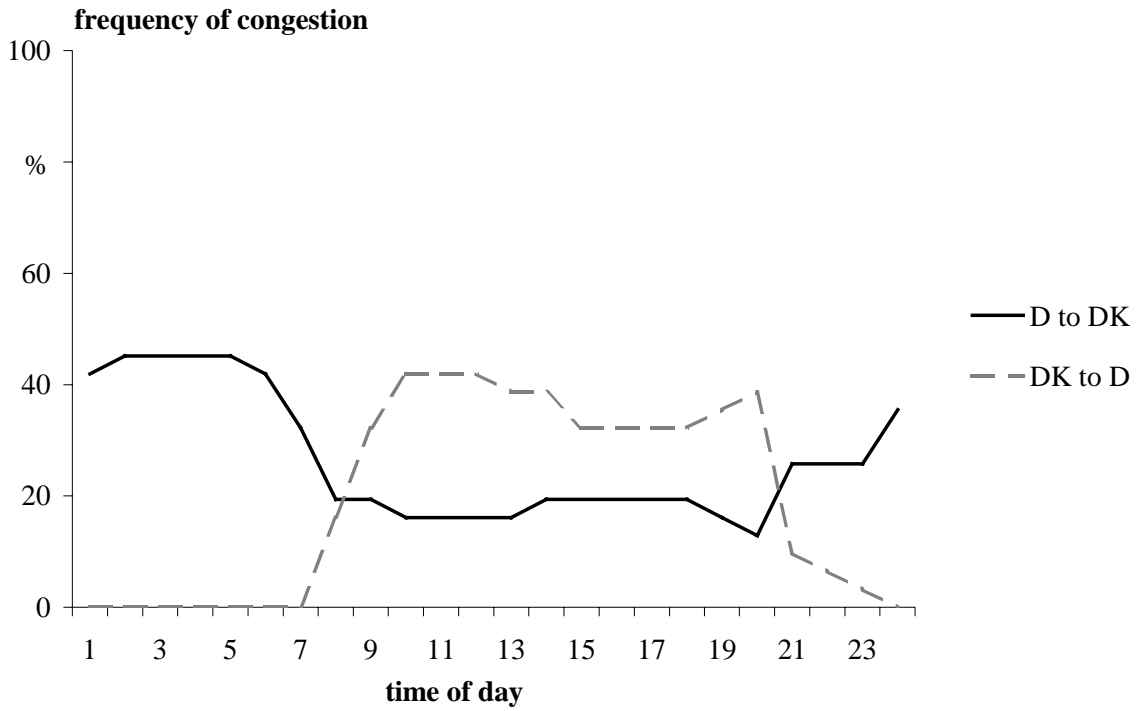

Fig. E.5: Frequency of congestion between Germany and Denmark in October 2000

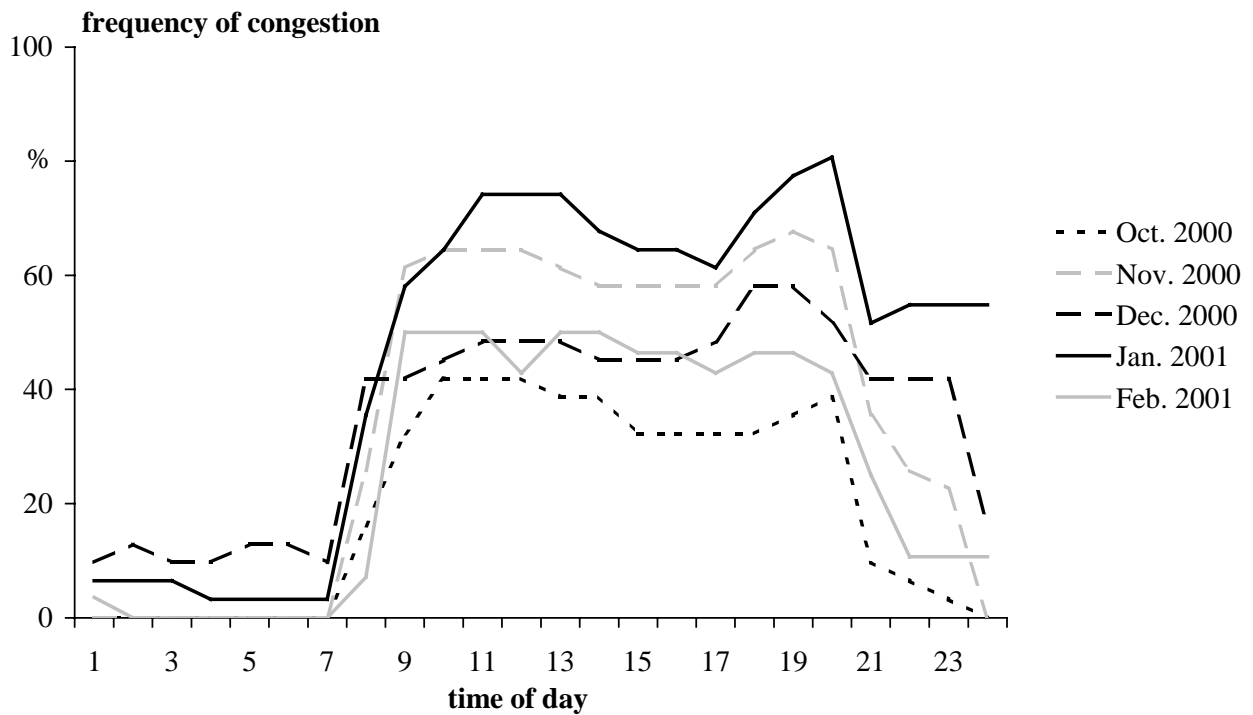

Fig. E.6: Frequency of congestion from Denmark to Germany between October 2000 and February 2001

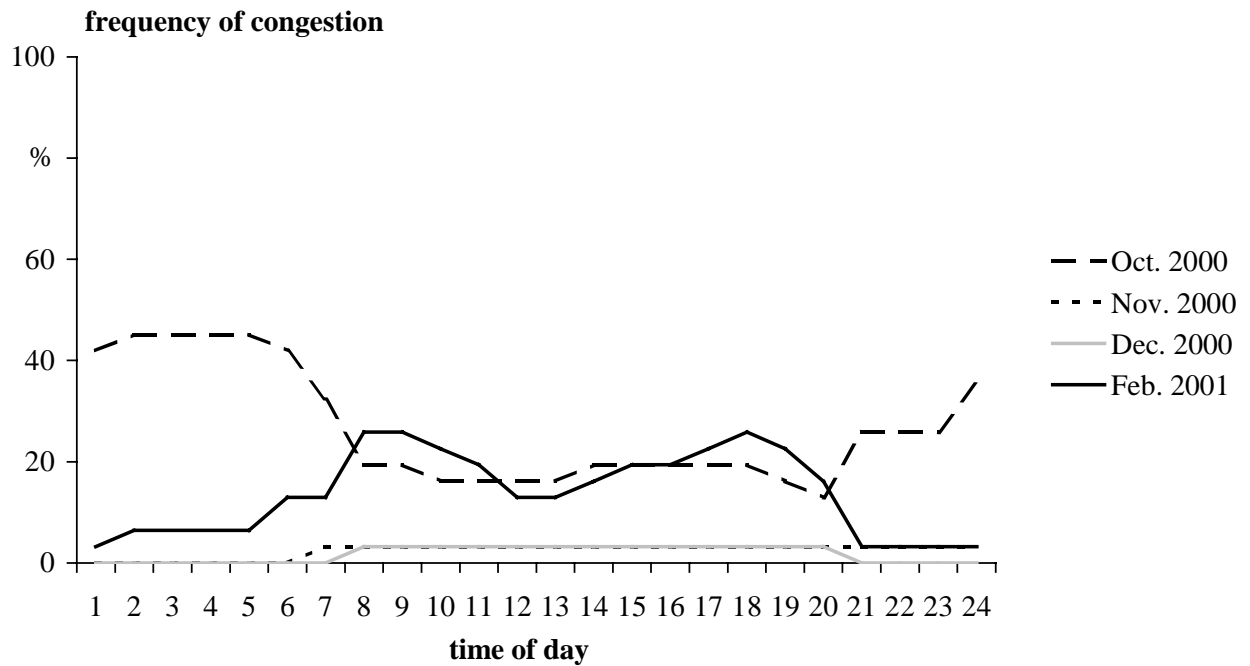

Fig. E.7: Frequency of congestion from Germany to Denmark between October 2000 and February 2001 (no case of congestion in January)

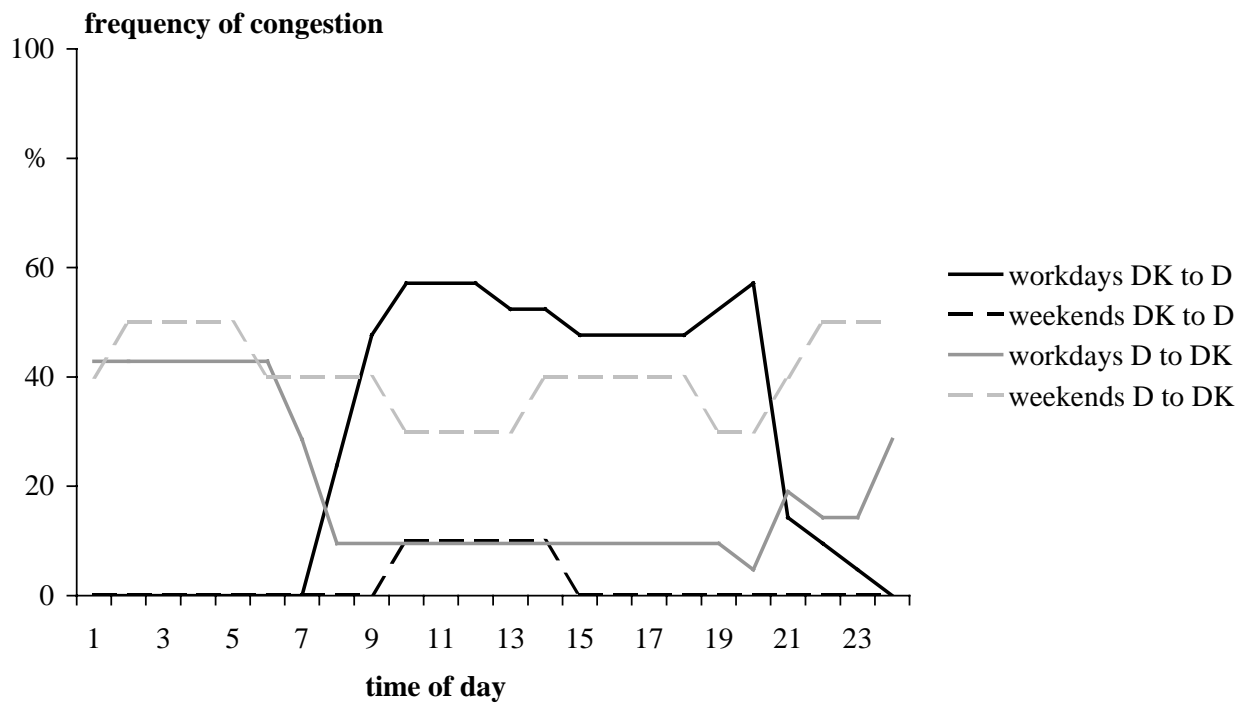

Fig. E.8: Frequency of congestion between Denmark and Germany: Comparison of workdays and weekends in October 2000

E.9 Germany ↔ Sweden

Existing interconnections

The grids of E.ON Netz (D) and Svenska Kraftnät (S) are linked by a DC cable (“Baltic Cable”) with a capacity of 600 MW.

Situation leading to congestion

The AC sides of the DC link’s converter stations have a nominal voltage of 380 kV. On the German side, however, no connection to the 380 kV network exists. Therefore, power transfer to and from Sweden must go across the regional 110 kV network. Here, the requirements on steady-state voltage impose restrictions impeding the full utilisation of the DC link’s capacity. Further restrictions may occur in the southern Swedish grid (cf. discussion on Norwegian-Swedish border, section E.14), so that the ETSO NTC values (which are equal to the actually usable capacity) amount to 370 MW (D→S) and 460 MW (S→D), respectively.

Severity of congestion

The DC link is so far exclusively used by the investors (E.ON Energie, Vattenfall and Sydkraft); therefore, no reliable information on the degree of congestion is available. However, we have been reported interest from traders to use this interconnection, too. Since it may serve as a bypass of the congested Danish-German border, congestion on the Baltic Cable is at least probable.

E.10 France/Switzerland/Austria/(Slovenia) ↔ Italy

At the northern Italian border, GRTN’s (I) grid is connected to the neighbouring networks by nine 220 kV and six 380 kV circuits (table E.7). (The neighbours include the Slovenian grid, which is, although not dealt with in this study, of great importance for the connection to Italy, because it can be used for transit from Austria and the east European countries.) Yet, these tie lines are not distributed homogeneously; especially the Austrian-Italian interconnection (only one 220 kV line) is very weak.

tie lines F/CH/A/SL ↔ I		U _N [kV]	capacity [MVA]
CH ↔ I	Riddes ↔ Avise	220	390
	Riddes ↔ Valpelline	220	390
	Morel ↔ Pallanzeno	220	340
	Airolo ↔ Ponte	220	340
	Lavorgo ↔ Musignano	380	1480
	Gorduno ↔ Mese	220	340
	Soazza ↔ Bulciago	380	1510
	Robbia ↔ Sondrio	220	340
F ↔ I	Albertville ↔ Rondissone	380	1550
	Albertville ↔ Rondissone	380	1550
	Villarodin ↔ Venaus	380	1190
	Le Broc Carros ↔ Camporosso	220	390
A ↔ I	Lienz ↔ Soverzene	220	230
SL ↔ I	Divaca ↔ Padriciano	220	370
	Divaca ↔ Redipuglia	380	1900

Table E.7: Tie line capacity on French/Swiss/Austrian/Slovenian-Italian borders

Situation leading to congestion

Since Italy is currently a high price area, there is a strong demand for power import. For import from or via France, Switzerland as well as Austria, the critical factor determining the limits of transfer capacity is the violation of thermal current limits.

At the **French-Italian border**, the critical incident is the simultaneous loss of both circuits between Albertville and Rondissone. (It has already been mentioned earlier that the TSOs include this (n-2) failure in their security analysis because of the associated risk of major supply interruptions in Italy.)

At the **Swiss-Italian border**, thermal overload may occur either on the 220 kV (workdays, peak generation in Switzerland) or the 380 kV level (off-peak periods, Switzerland importing or transiting).

The **Austrian-Italian border** is crossed by a single 220 kV line (Lienz-Soverzene) only. Because of the considerable distance to the neighbouring tie lines to Switzerland and Slovenia and the dominant position of the 220 kV level in Austria (due to the delay of 380 kV grid extensions) this tie line is

heavily loaded even in undisturbed situations. This forces Verbund APG (A) to frequently (almost half of the time) apply corrective topology changes. In many of these cases, the nearby Malta hydroelectric plant needs to be switched into directional operation towards Italy. (In fact, this topology change may also cause a re-dispatch because in directional operation the Malta plant cannot operate at its maximum due to the restricted capacity of the Lienz-Soverzene line.)

Severity of congestion

Market participants as well as the involved TSOs report permanent congestion on the Italian border. In addition, we have analysed on-line load flow information (available from ETRANS' web site) indicating the physical power flow on the Swiss borders which we have recorded every minute from mid-April to mid-May 2001 (fig. E.9).

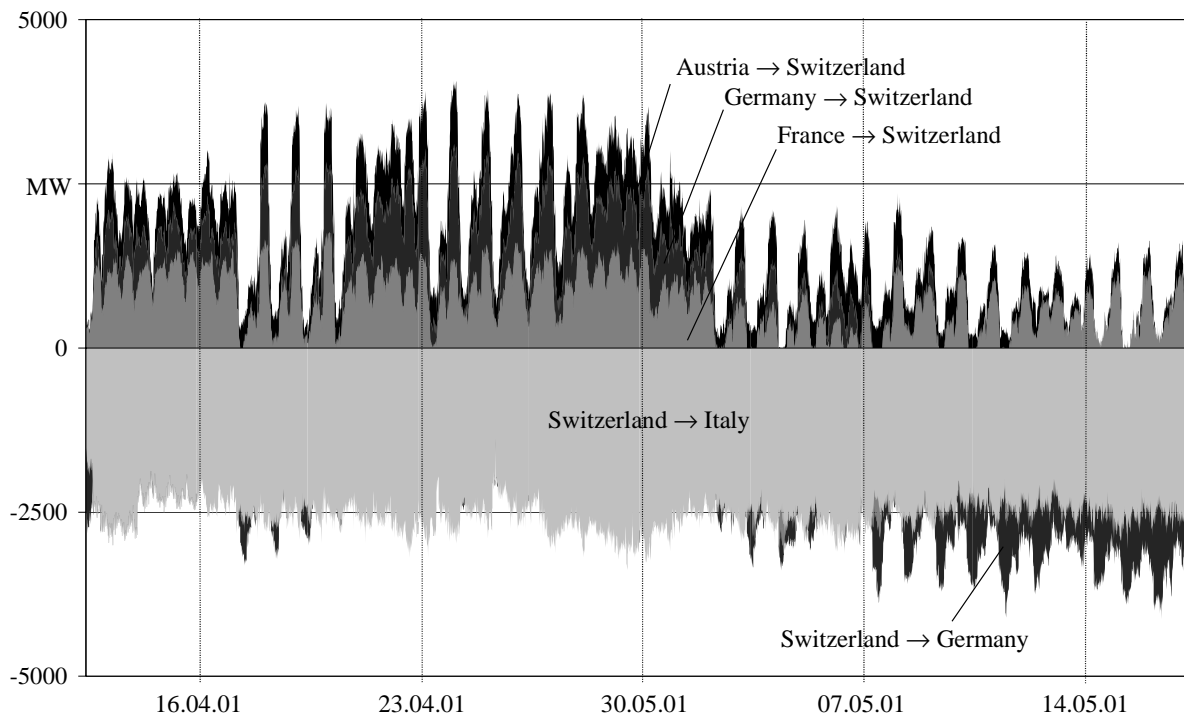

Fig. E.9: *Development of Swiss cross-border power flows in April and May 2001 (source: <http://www.etrans.ch>)*

The power flow between Switzerland and Austria, Germany as well as France shows a considerable variability with a daily cycle and, in the case of Germany, changing directions. In contrast, the export to Italy is almost constant and shows no daily or weekly cycle. Obviously, the Swiss export capacity to Italy is fully utilised all the time, with little variations of actual export only resulting from inadvertent

exchange and the natural load flow distribution between the different (Swiss and non-Swiss) Italian tie lines.

E.11 Austria ↔ Switzerland

Existing interconnections

Austria and Switzerland are connected by one 220 kV and two 380 kV circuits (table E.8).

tie lines Austria ↔ Switzerland	U_N [kV]	capacity [MVA]
Meiningen ↔ Montlingen	220	470
Westtirol ↔ Pradella	380	790
Westtirol ↔ Pradella	380	790

Table E.8: Tie line capacity on Austrian-Swiss border

Situation leading to congestion

In springtime, high hydraulic generation in western Austria (VKW area) in combination with low generation in the eastern Swiss (NOK) region may lead to congestion on the 220 kV interconnection.

Severity of congestion

This congestion is reported to be a rare incident of only minor, regional importance.

E.12 Austria ↔ Germany

Existing interconnections

Germany and Austria are linked by a large number of 380 kV and 220 kV lines (table E.9). About 20 additional 110 kV lines provide another 2 GVA of tie line capacity.

tie lines Austria ↔ Germany	U_N [Kv]	capacity [MVA]
Bürs ↔ Herberlingen	220	330
Bürs ↔ Obermooweiler	380	1370
Bürs ↔ Obermooweiler	380	1370
Bürs ↔ Dellmensingen	220	380*
Westtirol ↔ Memmingen	220	760
Westtirol ↔ Leupolz	380	990
Silz ↔ Oberbrunn	220	760*
Silz ↔ Oberbrunn	220	760*
St. Peter ↔ Simbach	220	300
St. Peter ↔ Altheim	220	300
St. Peter ↔ Pirach	220	460*
St. Peter ↔ Pleinting	220	460*

Table E.9: Tie line capacity on Austrian-German border

(* : capacity restricted by transformer or substation)

Situation leading to congestion

The border is intensely used for bilateral exchange between Germany and Austria as well as by transits and parallel flows, e.g. from the CENTREL area. Nevertheless, congestion occurs only very rarely, particularly resulting in a critical load on the St. Peter-Simbach tie line. This can however be relieved by topology adjustment so that no limitations are imposed on network users.

Severity of congestion

Owing to the rare occurrence and the availability of network-related countermeasures, this congestion is of subordinate importance.

E.13 Finland ↔ Sweden

Existing interconnections

The transmission grid of Finland is linked to Sweden by two 380 kV lines and a 220 kV line in the north as well as a DC cable in the south. Overall capacity according to [3] is 1450 MW (FIN→S) and 2050 MW (S→FIN), respectively.

Situation leading to congestion

Power transfer from Finland to Sweden is limited by static stability (oscillation between Finnish and Swedish generators). For the reverse direction, thermal limits constitute the critical factor, but depending on the scenario, voltage stability can also be critical. According to Fingrid (FIN), the critical incident is usually a bus bar failure in middle Finland or (sometimes in summer) a generator outage in the south.

Generally, congestion occurs mostly in summer when few thermal plants are connected and there is demand for import of hydroelectric power to Finland. The situation is exacerbated by the fact that import via the AC tie lines in the north adds to the predominant southbound load flow from the hydraulic plants in northern Finland to the load centre in the south.

Severity of congestion

Today, congestion from Sweden to Finland is a non-permanent, seasonal problem. Moreover, there are plans for a significant amount of new generation inside Finland so that congestion will probably become less frequent in the future.

E.14 Norway ↔ Sweden

Existing interconnections

Sweden and Norway have a rather long common border. Owing to the loosely meshed network structure, the cross-border network can be separated into three sections: one 400 kV and one 220 kV line in the north, a 300 kV line in the centre, and two 380 kV lines in the south. (Inside Norway, this separation corresponds to the three price areas for the Nord Pool market.)

Situation leading to congestion

A number of reasons lead to restrictions for the power transfer between Sweden and Norway. The generation mix is dominated by hydroelectric plants which are concentrated in south-western and northern Norway as well as northern Sweden. Generally, during peak hours there is demand for transmission of hydro power to the load centres in south-eastern Norway and Sweden, but also to Denmark and the UCTE system. In off-peak hours, cheap thermal power is imported by Norway. This general situation is however highly depending on the reservoir contents in the Nordic countries.

For the northern border section, transfer capacity is limited by a potential loss of static stability after a line failure (either one of the tie lines or an internal Norwegian line).

On the central interconnection Järpströmmen-Nea, thermal current rating constitutes the most restrictive limit.

Power transits from Denmark/Germany via Sweden to Norway are also restricted by thermal limits, in this case on an internal line in south-western Sweden.

Regarding transmission from southern Norway to Sweden, capacity is limited by different phenomena depending on the ambient temperature and the load in the Oslo region (fig. E.10). In case of higher temperature/lower load, static stability restricts capacity to a constant value. When load in Oslo increases, voltage stability becomes the critical factor, and cross-border capacity decreases with increasing load. Before the latest reinforcement (dotted line in fig. E.10), there was even a third effect when – in times of high temperature – thermal ratings became the limit. As Norway's export is highest during peak-load periods, most cases of congestion (i.e. when transmission capacity demand exceeds the available capacity) occur when Oslo load is in the right half of the diagram.

Since power exchange from Norway to Sweden is often related to further transport to Denmark and Germany, it might additionally be restricted by an internal Swedish limit for power transfer to the south. Here, the critical factor is the risk of voltage collapse. The shutdown of the first block of the nuclear power plant at Barsebäck as well as some smaller thermal units all located in southern Sweden has further increased north-to-south power flow and thus exacerbated this internal congestion.

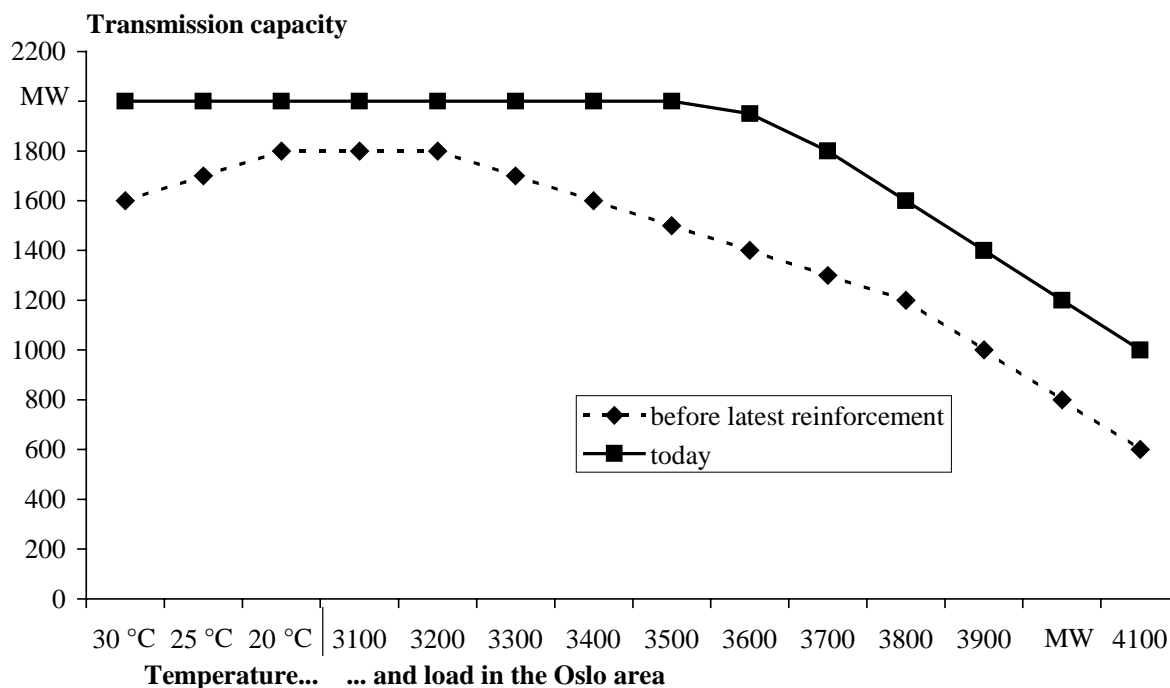

Fig. E.10: Dependence of capacity from southern Norway to Sweden on temperature and load in the Oslo area (source: Svenska Kraftnät)

Severity of congestion

The variability of hydraulic generation, the increasing interaction with the UCTE system and the amount of different effects and limitations lead to frequent congestion between Norway and Sweden with springtime being the most critical period. This is especially true for the southern section of the border where congestion is related to the mutual influence between Sweden's interconnections to Norway and to the south.

However, frequency and direction of congestion may differ significantly from one year to the next, as can be seen from figures E.11 and E.12 indicating the probability density of the power flow on the central and southern border sections in 2000 and 2001. The year 2000 was wet leading to high exports from Norway and frequent congestion on both border sections. As mentioned above, congestion in the south occurred mostly in periods when the capacity was below the maximum of 2000 MW, i.e. limited by voltage stability.

In 2001, which was a dry year forcing Norway to import, the situation at the central border section was mirrored with frequent congestion from Sweden to Norway, although not as frequent as in 2000. At the southern border, the curve for 2001 is much less steep than for 2000, i.e. there was much fewer congestion.

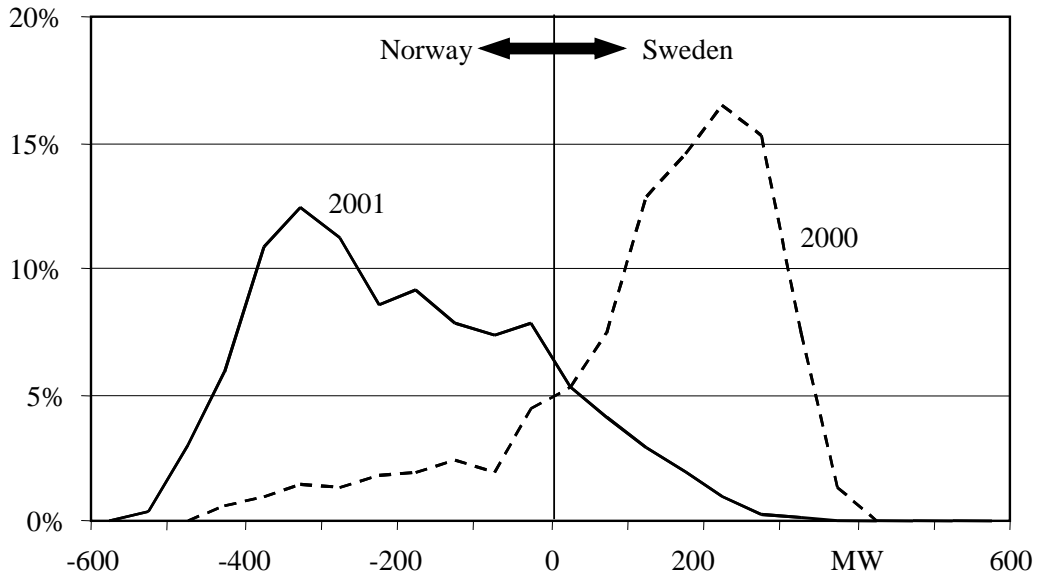

Fig. E.11: Probability density function of power flow on the Nea-Järpströmmen tie line between Sweden and Norway in 2000 and 2001 (source: www.statnett.no, data from 4 Apr 2000 until 26 Oct 2001);
transmission capacity limits: -490..490 MW [3]

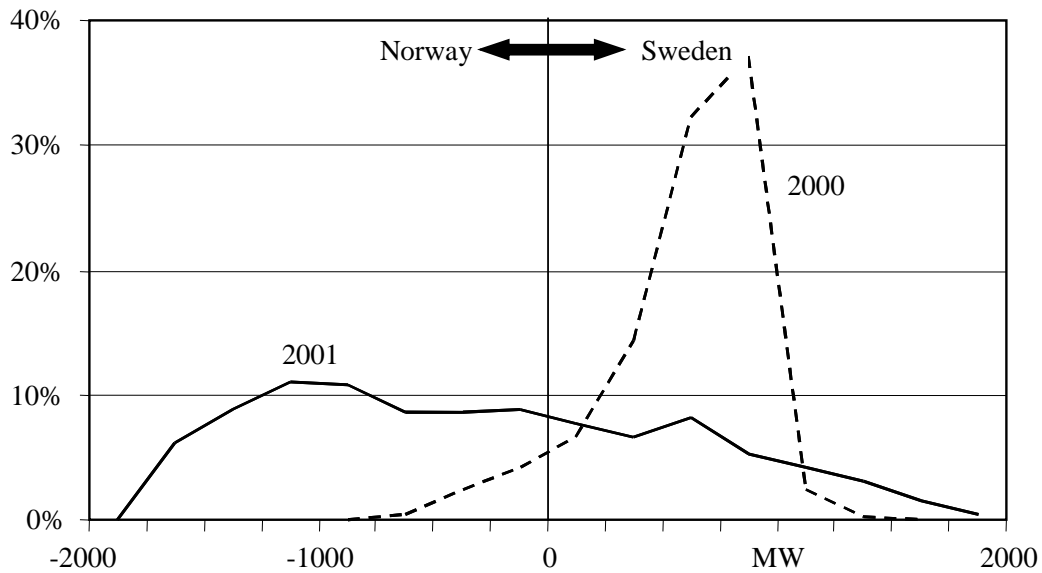

Fig. E.12: Probability density function of power flow on southern border section between Sweden and Norway in 2000 and 2001 (source: www.statnett.no, data from 4 Apr 2000 until 26 Oct 2001);
Transmission capacity limits: -1650 .. ≤ 2000 MW (cf. fig. E.10) [3]

F Details on investigations regarding transmission capacity demand

F.1 Details on the model-based investigation for France-Italy

F.1.1 The model EUDIS

Background

The determination of prices in an electricity spot market, the dispatch of power plants and power imports and exports depend on various factors.¹ It is a major task for a model to determine those being the most crucial factors in a certain market situation. The wholesale electricity markets in most European countries are deregulated now. Due to excess capacity in many countries as well as the entrance of new market players there is a high level of competition on national power markets which are interconnected through cross-border electricity flows. Therefore perfect competition is the most appropriate model assumption. Even in cases where market power prevails model results based on competitive behaviour are useful as a benchmark.

Basic model structure

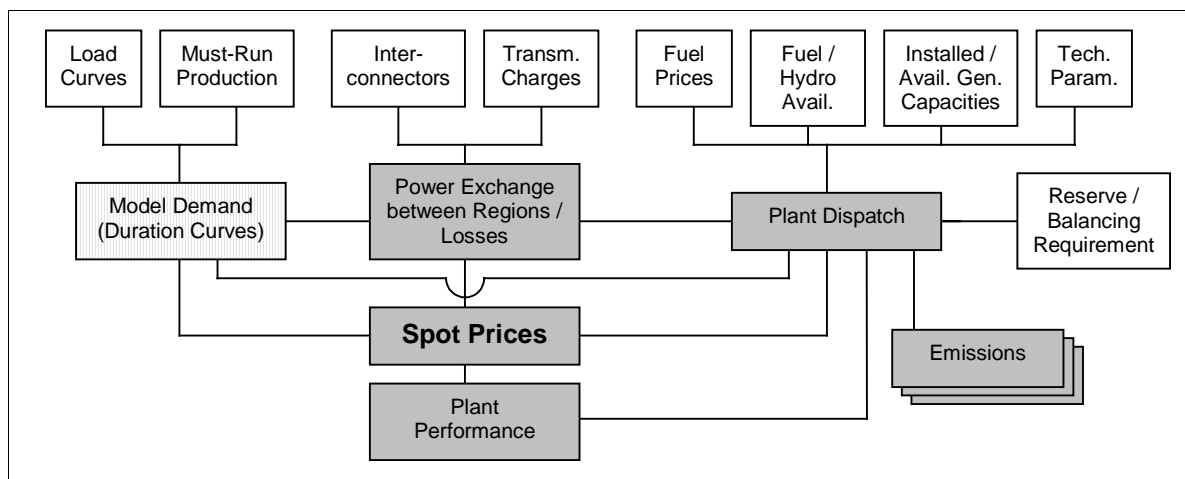

Fig. F.1: Interactions in EUDIS

¹ See for example, Schweppe et al.: Spot Pricing of Electricity, Kluwer Academic Publishers, 1987.

The basic interactions between inputs and outputs of the EUDIS model are summarised in fig. F.1. In the white squares exogenous input data are shown, the dashed square is the result from a crucial transformation of exogenous parameters within the model and the grey squares show some of the most important endogenous outputs. The following subsections will give a short overview of the elements in fig. F.1 and the interactions between them.

Regional resolution of the model

EUDIS uses detailed information about generation capacities and load within and transmission capacities between the seven model regions shown in fig. F.2.

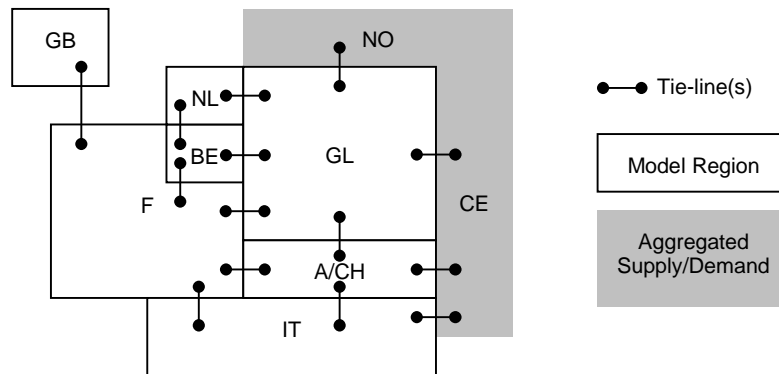

Fig. F.2: Interconnected regions of the model

Some countries are merged to one region in order to save computing time if these are sufficiently homogenous and network congestion between these countries is not very likely. Germany and Luxembourg are combined to one region (GL) as well as Switzerland and Austria (Alpine Countries, A/CH). The Scandinavian Countries and Central-Eastern European Countries (CENTREL Region and Slovenia) are not modelled in detail. Interactions are included using aggregated supply and demand functions to represent power exchanges.

Power flows and interconnections

Within these regions there is almost no transmission congestion in reality. The high voltage grid within regions can usually cope with all kinds of economic power flows. E.g. no grid constraints have been reported during the first year at the LPX. Thus it is a realistic assumption in the EUDIS model to neglect power flow constraints within a region for power plant dispatch decisions. Power exchange between regions is based on the fiction of contract paths under the constraints of maximum transfer

capacities. Electricity flows from one model region to another occur if the differences in marginal costs between both regions are higher than the compensations for transmission losses and transmission fees. Such flows are increased by the model until either an economic equilibrium is found or until transmission capacity between the two regions in question is fully utilised.²

Load

In each region the load level (to be covered by the thermal and hydro power plants) is determined for the 24 hours of the day for working days, Saturdays and Sundays for the 12 months of a year (864 distinct load levels per year). The load levels are determined in three steps: First the load structure is estimated using historical data, second the load structure curve is scaled with the expected annual total electricity demand, third generation by must-run plants (Combined Heat and Power generation, CHP, and Renewable Energy Sources, RES) is subtracted from the scaled load curve to arrive at the load which must be covered by the thermal and hydro power plants.

Generation capacity

Power generation capacities in each region are aggregated into 9 technology groups and vintage groups spanning 5 years to reduce the number of variables. The model can vary the dispatch of power plants from a technology/vintage-group in steps of 1 MW net capacity.

The model comprises the following technologies:

- **Thermal:** Lignite, Hard Coal (HC), Gas CCGT (combined cycle gas turbines), Gas OCGT (open cycle gas turbines), Oil, Nuclear (NUC)
- **Hydro:** Run-of-River (RoR), Storage (S), Pump-Storage (PS)

The model uses 12 vintage classes each of which comprises 5 years spanning 60 years from 1950 to 2010 (for long-term forecasts).

Table F.1 lists the parameters which are used in the model for the dispatch decision.

² In the model electricity is first transferred via the cheapest (usually direct) route. If this is full, other (indirect) routes are used as long as this saves costs.

Parameter	Specifications	Unit
Type of fuel	hard coal, natural gas, nuclear, hydro...	
Technology	steam turbine, gas turbine, combined cycle turbine,...	
Fuel price		Euro-Cent/kWh _{th}
Fuel budgets	maximum amount of fuel that can be used per month (mainly for hydro storage)	kWh _{th} /month
Capacity	net capacity (minimum 1 MW net)	MW _{el}
Availability	percentage of capacity which is available in a certain month	%
Electrical efficiency	electrical energy output / energy input	%
Minimum load	fraction of capacity below which a plant cannot be operated	%
Start-up costs	fuel and attrition costs to start up a plant	Euro-Cent/kW _{el}
Ramp rates	fraction of capacity by which a plant can increase its load per minute	%/min
Other variable costs	aggregate of attrition, environmental protection, and other costs	Euro-Cent/kWh _{el}

Table F.1: Technical parameters of power generation facilities

Planned revisions and forced outages are taken into account by reducing the maximum monthly available capacity. Lignite plants, run-of-river plants and (pure) storage plants are additionally restricted by monthly energy budgets derived from historical data.³

Reserve and balancing capacity

While the amount of capacity held back for reserve and balancing needs is exogenous, based on UCTE recommendations for reserve and balancing capacity, the choice of power plants serving these functions is endogenously determined on the basis of costs and technical requirements.

Solution and results

The EUDIS model solves a linear programming problem subject to constraints. The objective function represents variable costs incurred to cover the load in all model regions. The solution of the problem is minimising these costs separately for twelve independent months. Thus the results describe the least cost dispatch of the total set of power plants in the EUDIS regions given constraints on available

³ Since the model's optimisation period is one month this is an opportunity to take longer term optimisation decisions into account.

power generation and transmission capacities as well as technical properties and variable costs of the power plants.

F.1.2 Parameterisation

Apart from model structure, quality of input data is crucial for the quality of model results. Especially data which characterise the currently existing power plants and transmission capacities as well as load and fuel price data are of great importance. EUDIS draws these data from EWI's own data bank, which contains comprehensive technical information (net capacity, type of fuel, technology, date of commissioning or re-powering, location, historical generation data,...) for thermal and hydro plants as well as data on transfer capacities between regions, fuel prices and load in the regions. Keeping this data base up to date requires a considerable amount of resources. Using only official sources on the national (e.g. Electricity Industry Review for UK) and international level (e.g. Eurelectric statistics and UCTE statistics) is by far not sufficient to get detailed and reliable sets of data. Therefore, these statistics must be refined using data provided in a very time consuming process by other sources (e.g. information from individual generators). The whole data base is subject to a perpetual updating process by EWI. The following tables (table F.2 to table F.5) show some of the assumptions on crucial input parameters used for this investigation.

Table F.2 shows total annual demand and exogenous production in the model regions in 2001. The annual model demand is total annual demand in the regions minus exogenous production. Since the share of exogenous production varies between months, day types and hours exogenous production is not subtracted from annual demand on a yearly aggregation level but the approach described above is used.

[TWh]	A/CH	F	GL	GB	NL	IT	BE	Total
Annual Demand	114.3	451.2	528.4	368.3	109.1	302.8	82.4	1956.4
Exog. Production	18.1	28.6	118.0	28.0	35.6	64.0	12.6	304.9
Model Demand	96.2	422.6	410.4	340.3	73.5	238.8	69.8	1651.5

Table F.2: Annual demand and exogenous (must-run) production in 2001

Aggregated model generation capacity (net capacity) by technologies and regions is shown in table F.3. The table does not include CHP and RES capacities which are considered by reducing model demand.

[GW]	A/CH	F	GL	GB	NL	IT	BE	Total
Hard Coal	1.0	8.0	21.4	22.3	2.9	7.1	3.0	65.7
Gas CCGT	0.6	0.0	9.6	20.7	5.4	18.8	3.4	58.4
Gas OCGT	0.5	0.9	3.3	1.8	0.5	6.7	0.4	14.1
Lignite	0.3	0.0	18.1	0.0	0.0	0.0	0.0	18.4
Oil	1.0	6.8	3.0	5.1	0.0	13.3	0.1	29.3
Nuclear	2.9	63.2	20.9	13.3	0.4	0.0	5.7	106.6
Hydro RoR	8.4	7.5	2.6	1.4	0.1	3.4	0.1	23.4
Hydro S	13.8	13.6	1.5	1.5	0.0	10.3	0.0	40.7
Hydro PS	2.0	4.3	5.3	2.8	0.0	6.0	1.3	21.7
Total	30.5	104.3	85.8	69.0	9.3	65.5	14.0	378.3

Table F.3: Aggregated model capacity in 2001

Table F.4 shows annual averages of fossil fuel prices for the year 2001. Since fuel prices vary considerably over the year monthly prices are used in the model runs.

[ct/kWh _{th}]	GL	F	A/CH	BE	NL	GB	IT
Hard Coal	0.75	0.75	0.84	0.72	0.72	0.75	0.75
Gas	1.55	1.55	1.55	1.40	1.40	1.40	1.40
Oil	1.34	1.34	1.34	1.34	1.34	1.34	1.34

Table F.4: Fuel prices in 2001

The net transfer capacities in table F.5 are based on the publications of ETSO. In most cases the original values for NTCs between two countries as well as common restrictions for three countries are implemented. In the case of the border between Alpine Countries and Germany the values between Austria and Germany and Switzerland and Germany are added. The NTC value from Alpine Countries to Italy is the sum of the NTC values from Switzerland to Italy, Austria to Italy and Slovenia to Italy. Thus we assume that the Swiss-Austrian border is not a bottleneck as well as Slovenia is only used as a transit country with respect to power flows from Alpine Countries to Italy. Two further adjustments are made: The NTC values for the French-Swiss border are computed from the common NTC value from France to Switzerland and Italy minus the NTC value from France to Italy. The definition of summer and winter months corresponds to the definition used by GRTN.

From Region	To Region	Net transfer capacity in MW	
		Summer Months	Winter Month
BE & GL	NL	3,600	3,600
F & A/CH	IT	5,000	5,400
F	BE & GL	2,600	3,750
F	A/CH & IT	4,600	4,950
NL	BE & GL	3,600	3,600
GL	F	1,750	2,250
GL	A/CH	2,700	3,650
GL	NL	3,600	2,800
GL	NORDEL	1,720	1,720
GL	CE	2,000	1,200
F	GL	2,350	2,850
F	A/CH	2,800	2,950
F	BE	1,500	1,800
F	GB	2,000	2,000
F	IT	1,800	2,000
A/CH	GL	2,600	2,600
A/CH	F	no realistic limit	no realistic limit
A/CH	IT	3,200	3,400
A/CH	CE	1,100	2,000
BE	F	1,600	2,500
BE	NL	2,200	1,400
NL	GL	no realistic limit	1,350
NL	BE	1,700	1,700
GB	F	2,000	2,000
IT	F	no realistic limit	no realistic limit
IT	A/CH	no realistic limit	no realistic limit
NORDEL	GL	2,210	2,210
CE	GL	2,350	2,250
CE	A/CH	1,400	1,400

Table F.5: NTC values used for the model

F.1.3 Simulation results

As described section 5.3, the value of both the presently existing and additional net transfer capacity from France to Italy is highly sensitive to the utilisation of the existing power plants and their variable costs within both countries as well as to the utilisation of the transmission capacities between both countries. It follows that the value of transmission capacity varies significantly with the season, day type (working day, Saturday, Sunday) and even with hours and a disaggregated analysis is necessary. In the following subsections we describe the main determinants of the value of transmission capacity. This analysis will explain the level and changes over time in the values of present and additional transmission capacities more deeply. January is chosen to represent a typical winter month and July to represent a typical summer month.

Utilisation rate of transmission capacity

Additional (marginal) transmission capacity is valuable (by reducing power generating costs) in periods when the whole available transmission capacity is fully utilised. Therefore the monthly averaged utilisation rate (see fig. F.3) serves as a rough indicator for the value of marginal transmission capacity. The transmission capacity from France to Italy is fully utilised in four months of the year 2001 (March, August, September and October). This means that a (marginal) increase in NTC value would reduce generation costs in all hours of these months. In other months average utilisation rates vary between 92 and 99 % with the tendency to be lower in winter months.

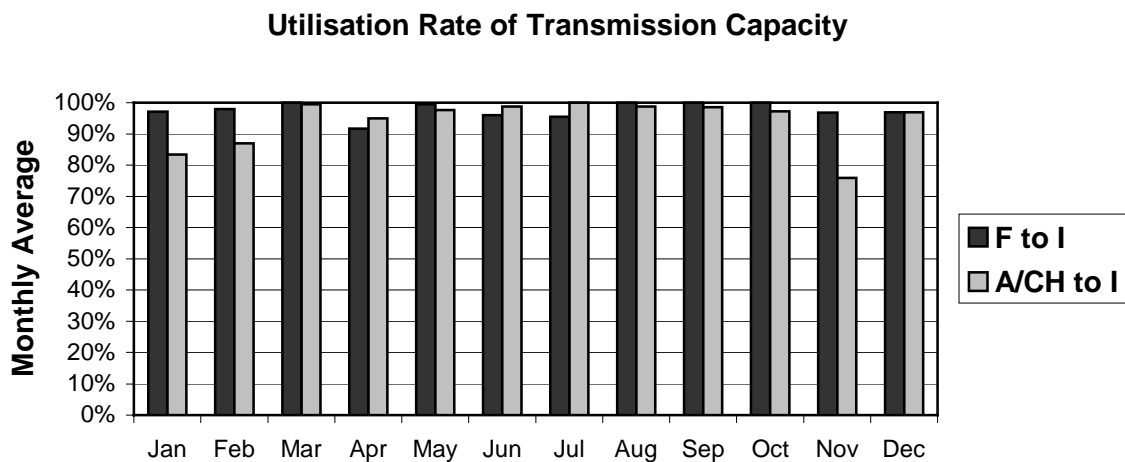

Fig. F.3: Monthly averaged utilisation rate of transmission capacity from France to Italy and from Alpine Countries to Italy; base scenario – year 2001

Fig. F.4 shows hourly power flows from France to Italy in January and July 2001. In both months transmission capacity is fully utilised all the time with the exception of the very peak hours (in January during the evening peak at 8 p.m. and in July on working days around noon). Thus in almost all hours a (marginal) increase in transmission capacity reduces variable system costs. The amount of system cost reductions by a marginal increase of transmission capacity cannot be derived without further information. The amount depends mainly on two factors, first the spread between the marginal generation costs in France and Italy, second the opportunities to use routes via third countries – in the case of France and Italy especially Switzerland – for power exchange⁴.

⁴ If some transmission capacity from France to Alpine Countries as well as from Alpine Countries to Italy is idle while the interconnector from France to Italy is fully utilised the compensation for transmission losses of the

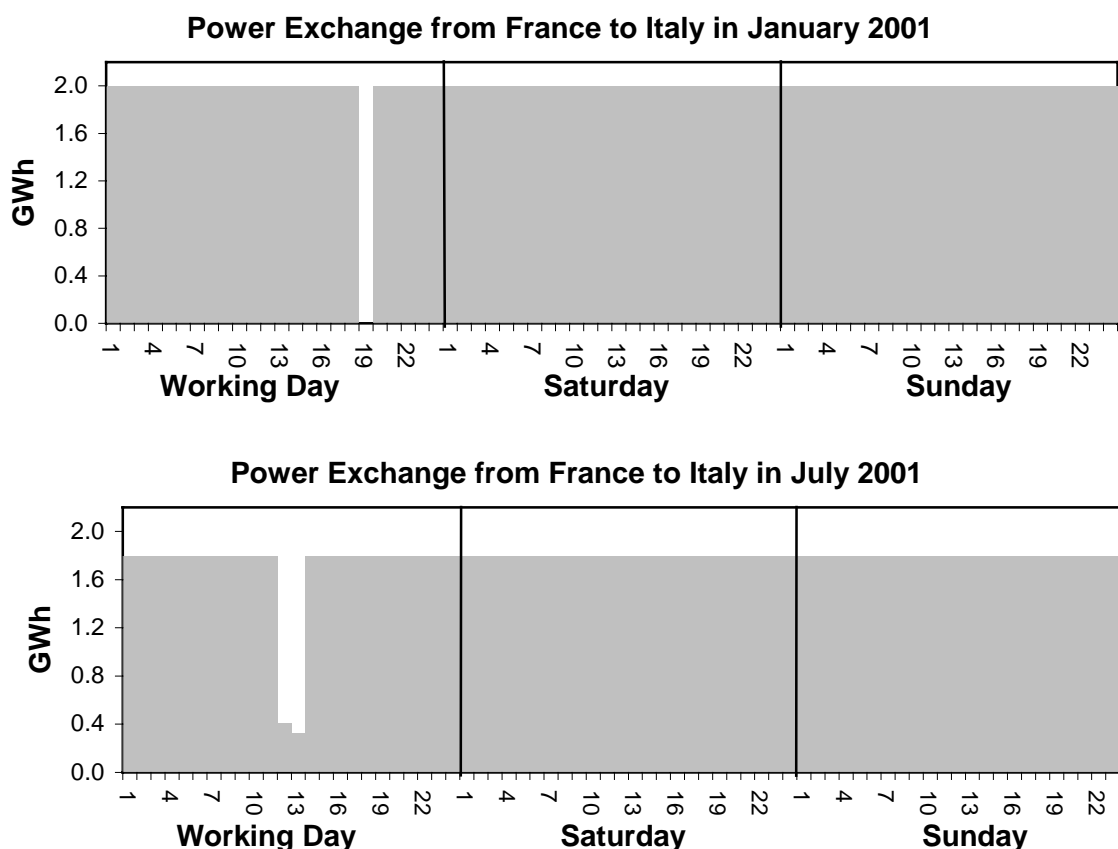

Fig. F.4: Hourly power exchange from France to Italy; base scenario – January and July 2001

Power generation and capacity

Fig. F.5 shows used and available generation capacities of thermal power plants by fuel in France and Italy on an annual average basis. Hard coal power plants in Italy run near full capacity over the whole year. Thus in most periods more expensive gas- and oil-fired power generation technologies are used in addition. Marginal variable costs in Italy are determined by these power plants if transmission capacities from neighbouring countries are fully utilised. In France there is much idle hard coal capacity and even some idle nuclear capacity on an annual average basis. In most periods the spread in marginal power generation costs between France and Italy is the difference between variable generation

indirect route exceeds the spread between marginal generation costs in France and Italy. Otherwise the model would use this route.

costs of French hard coal power plants and Italian combined cycle power plants.⁵ In some periods variable costs of French nuclear capacity and Italian oil-fired power plants have widened the spread.⁶

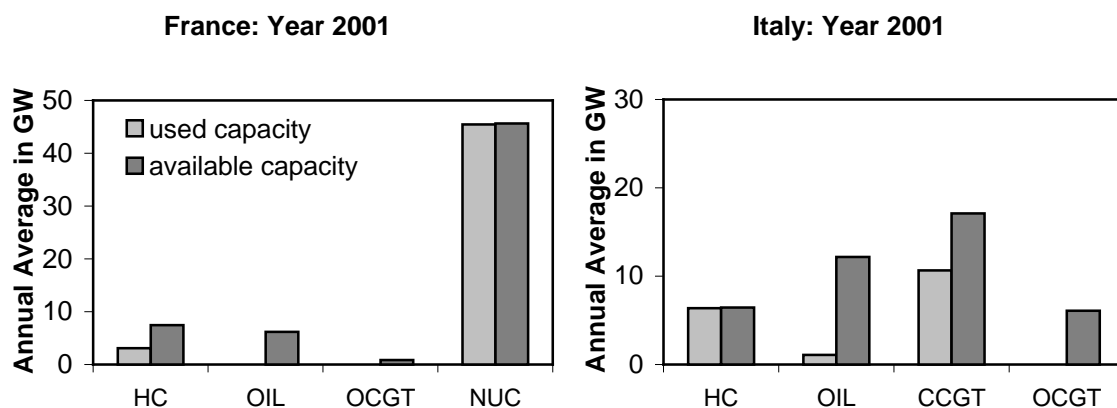

Fig. F.5: Average used and available capacity by technology in France and Italy; base scenario – year 2001

Fig. F.6 shows the situation on a monthly aggregation level for January and July. While the used and idle capacities by technologies in Italy are very similar in January and July, the situation in France changes significantly. In January the utilisation rate of hard coal power plant capacity is more than 85 % on a monthly average whereas it is just around 3.5 % in July. In general there are more hours with (and a larger amount of) idle hard coal (and nuclear) capacities in summer months than in winter months. Therefore the marginal value of transmission capacity from France to Italy is higher and the range of additional transmission capacity from France to Italy with considerable cost reduction opportunities is broader in the summer than in the winter season.

⁵ Due to start-up costs the spread in variable generation costs between different power plants is not constant but depends on the load situation (whether or not the power plant has been run in the previous hours and will be run in the next hours).

⁶ Despite the low start-up costs open cycle gas turbines (OCGT) are not even used in peak load periods in Italy as well as in France because of the high gas prices in year 2001.

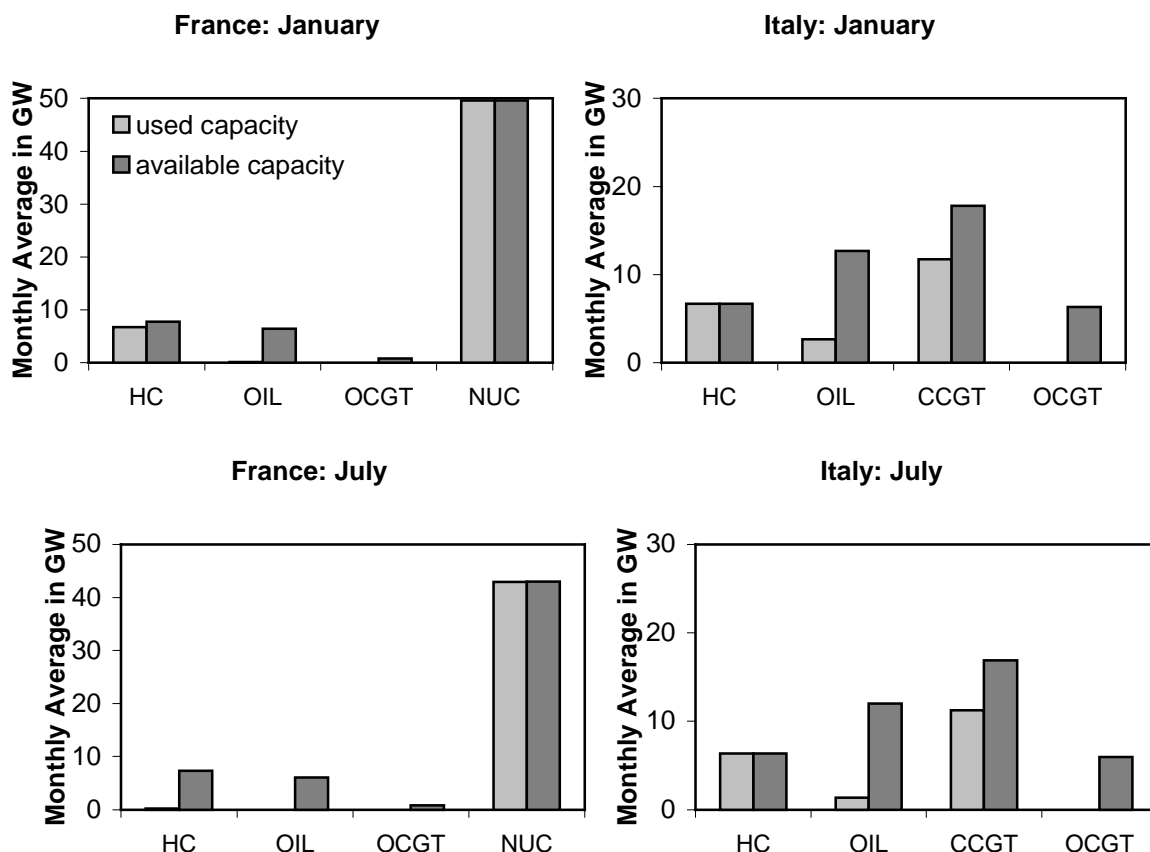

Fig. F.6: Average used and available capacity by technology in France and Italy; base scenario – January and July 2001

Prices

Price estimators in EUDIS are based on system marginal costs. Regional prices are determined by the costs in the whole system caused by an additional kW of load in a certain hour in a certain region. Thus differences in these prices can be used as an indicator for the maximal savings in the whole system by a marginal increase in transmission capacity. Fig. F.7 shows price duration curves for France and Italy with varying assumptions about the NTC from France to Italy. Price duration curves show prices over a period sorted in descending order. Prices in France are always much lower than prices in Italy for initial NTC values. The difference in prices widens considerably from peak to off-peak prices. This indicates high differences particularly in base load generation costs.⁷ Adding 2,000 MW

⁷ The prices in France are about 5 Euro/MWh for more than 1,000 hours. In these times nuclear power plants determine the prices.

of NTC reduces the differences but the regions are still far from being integrated. If NTC from France to Italy is increased by 10,000 MW the countries are almost entirely integrated.

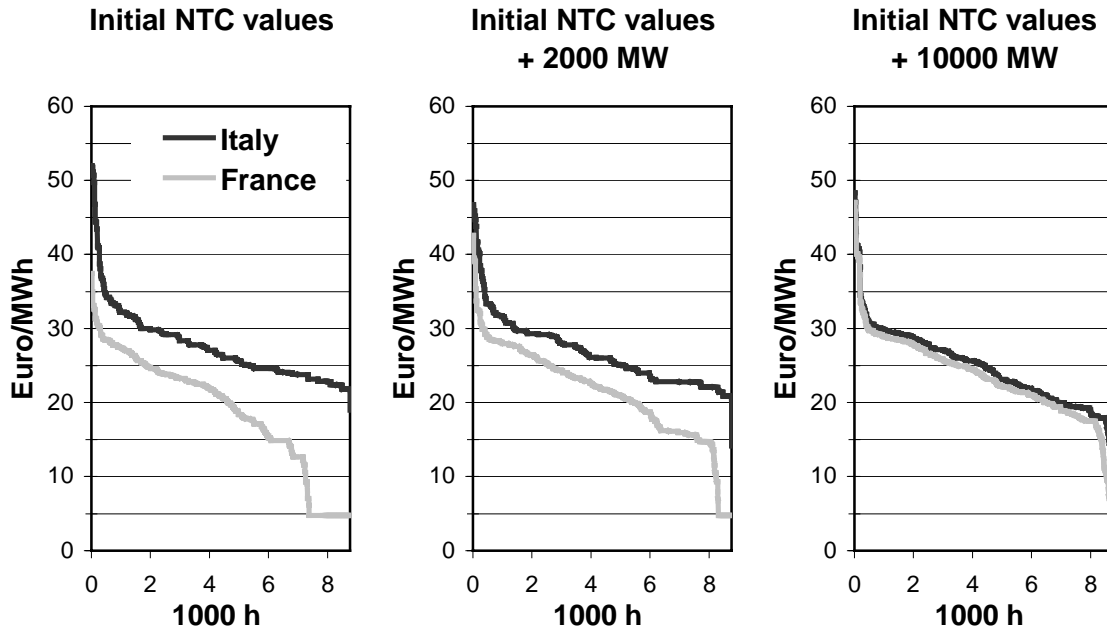

Fig. F.7: Price duration curves for France and Italy with varying NTC values from France to Italy; model results – year 2001

F.2 Details on the evaluation of publicly available energy forecasts

F.2.1 Introduction

Forecasts about the development of the European electricity market are issued more or less periodically by a number of organisations like authorities and associations. A selection of these forecasts are presented in section F.2.2. In section F.2.3, we discuss essential tendencies with respect to the demand of cross-border transmission capacity that can be derived from these forecasts.

In principle, forecasts can be distinguished according to various characteristics. The most important feature of a forecast is the time horizon that it covers. The forecasts that we have analysed can basically be subdivided into short-term forecasts covering one up to few years, mainly based on concrete planning information e.g. from generation companies, and long-term forecasts covering a horizon of up to 20 years, usually based on complex forecast models and/or market surveys.

We consider the analysis of short-term forecasts more relevant within the scope of this study for the following reasons:

- Generally, long-term forecasts are significantly less certain than short-term forecasts. This is particularly true for energy forecasts as has been recognised frequently in the past.
- The relevant quantity to be analysed here is the expected volume of cross-border energy exchanges. This quantity has to be considered rather a “secondary quantity” that cannot be directly predicted, in contrast to the “primary quantities” load and generation that are usually the fundamental result of energy forecasts. This is because it is usually not a basic objective of governments and market actors to achieve a certain level of cross-border exchanges. Rather, the level of exchanges is a result of national load and generation balances and generation cost structures. Therefore a forecast of cross-border exchanges can only be derived as a residual value between load and generation forecasts which is of course affected even more by the unavoidable uncertainties of any forecast than the “primary quantities” themselves. This is particularly due to the fact that cross-border exchanges represent only a relatively small part (magnitude: 10-20 %) of the total load and generation volumes. As a consequence, in view of the considerable uncertainties of long-term load and generation forecasts, it appears almost impossible to predict cross-border exchanges in the long term with good accuracy.
- Finally, the main objective of this study is to evaluate opportunities to increase cross-border transmission capacity already in the short term, and not only in the long term. For this purpose, short-term forecasts are clearly more relevant.

Nevertheless, we have also included long-term forecasts in our analysis in order to verify if the tendencies identified by short-term forecasts are also expected to hold for the longer term.

F.2.2 Forecast documents

The analysed forecast documents are on the one hand – as mentioned before – issued by organisations, on the other hand publications from TSOs, for example annual reports. It turns out that only a few forecasts are included in TSO documents, so only two statements from this type of publications are referred to in the following.

“Power and energy balance of the UCTE - Forecast 2001-2003”

Every year a short-term forecast is published by the UCTE called “Power and energy balance of the UCTE”. The methodology applied by UCTE is based upon those data which become available to transmission system operators in the conduct of their specific tasks, for example installed generating capacity and system load. As a result of increasing competition, the emergence of power exchanges and new contractual relations with customers, it was not possible for the forecast that we have taken

into consideration (“Forecast 2001-2003”) to obtain certain data regarding the management of generating facilities or future contractual exchanges. This has led to the abandonment of the energy balance forecast (approximately half of the member countries were unable to supply the corresponding data).

Furthermore the transmission system operators were no longer able to draw up a reliable forecast of cross-border power exchanges. A comparison is therefore drawn between load and guaranteed generating capacity of power plant operators (after reductions for the various sources of unavailability – non-usable capacity, scheduled and unscheduled outages – and for the reserves required by transmission system operators for the provision of network services) in order to derive the resulting balance as the potential for export, if positive, or a requirement for import, if negative. This so-called remaining capacity for 2001 and 2003 is shown in fig. F.8. The balances correspond to the synchronous capacity of the entire UCTE network. The points in time used as reference load cases are the third Wednesday of January and the third Wednesday of July at 11 a.m.

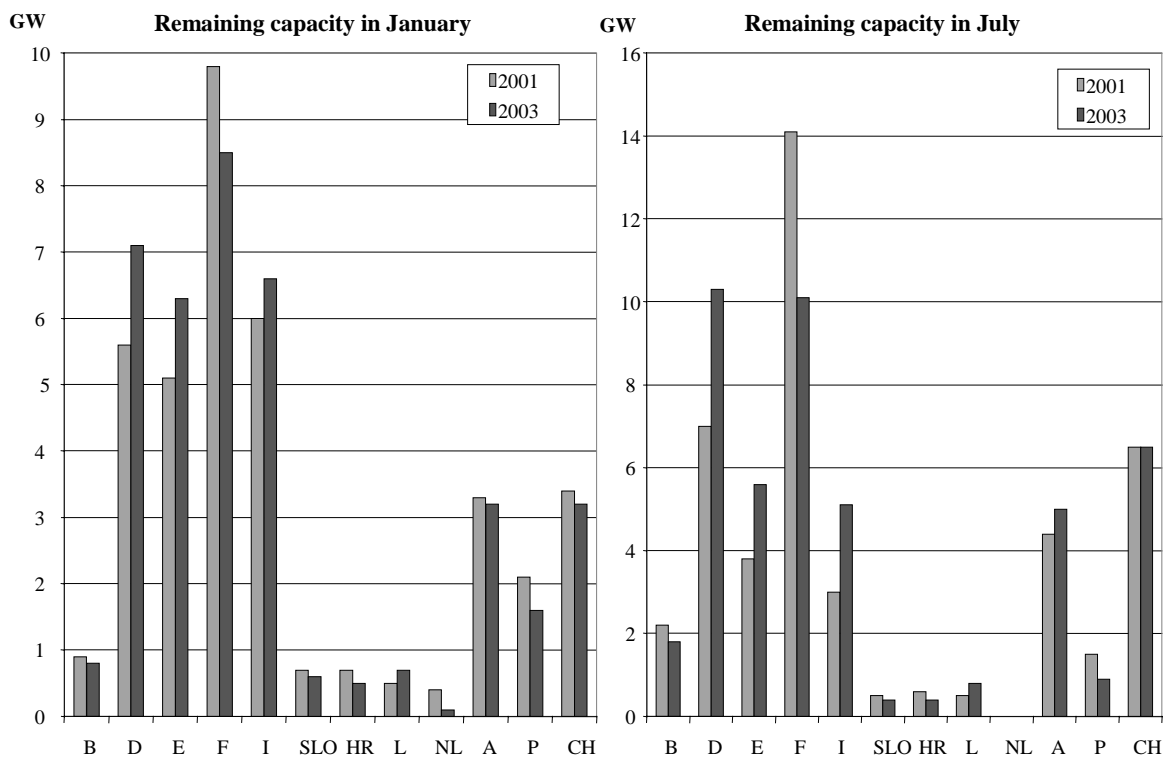

Fig. F.8: Remaining capacity in January and July 2001 and 2003 as given by the UCTE forecast

“Power balance in the interconnected European power markets – Forecast 2001-2003”

In March 2001, another forecast was published by UCTE in co-operation with NORDEL, UKTSOA and ATSOI, called “Power balance in the interconnected European power markets – Forecast 2001-2003”. It is mainly based on the aforementioned UCTE methodology, but the areas of NORDEL (DK, ICE, N, FI, S), Great-Britain (UKTSOA) and Ireland (ATSOI) were added. This “joint-TSO-forecast” is based on forecasts from all three organisations. Because NORDEL and Ireland only do multi-year forecasts for the annual peak load, whereas UCTE considers two reference load cases, the common forecast omits the UCTE July data and concentrates on January data. Therefore the NORDEL reference load data and margins to peak load had to be estimated. In the view of our objective to estimate the development of remaining capacity (i.e. the difference between 2001 and 2003), differences in the reference load cases selected by different forecasts do not appear to be a critical factor, compared to other sources of uncertainty that cannot be avoided. Remaining capacity at reference and peak load time for 2001 and 2003 as estimated by the “joint-TSO-forecast” is shown in fig. F.9.

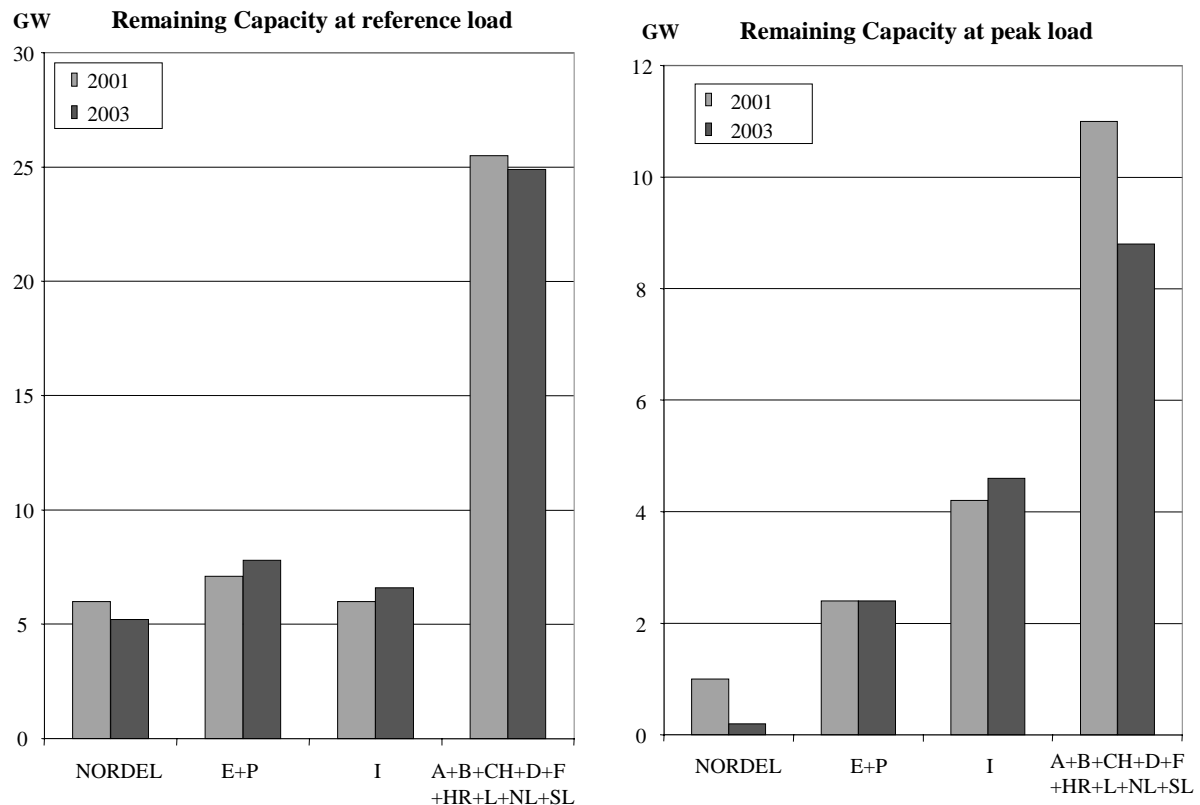

Fig. F.9: Remaining capacity at reference and peak load as given in “Power balance in the interconnected European power markets – Forecast 2001-2003”

“Kraftbalanser for treårsperioden 2001-2003 och Sannolikheten för effektbist i Nordel-systemet driftåren 2000/2001 till 2002/2003”

Another analysed forecast document, called “Kraftbalanser for treårsperioden 2001-2003 och Sannolikheten för effektbist i Nordel-systemet driftåren 2000/2001 till 2002/2003”, is issued by NORDEL. The methodology applied by NORDEL is, just as the UCTE methodology, based upon those data which become available to transmission system operators in the conduct of their tasks. NORDEL also determines remaining capacity from load and guaranteed generating capacity of power plant operators (installed generation capacity minus unavailability and minus reserves required by transmission system operators for the provision of network services), but the prediction of load and generation capacity is – different to the UCTE approach – calculated for individual annual peak loads and not for a commonly agreed reference load case. The calculated remaining capacity of the NORDEL countries is shown in fig F.10 for 2000/2001 and 2002/2003.

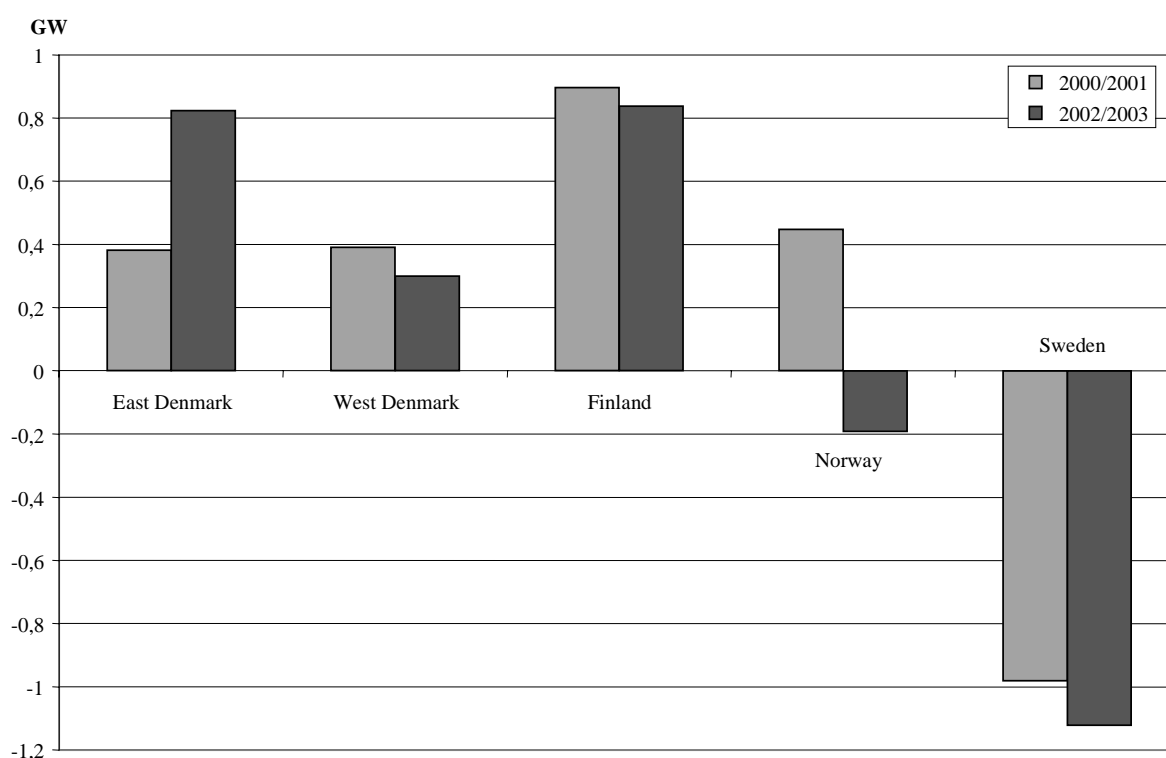

Fig. F.10: Remaining capacity for 2000/2001 and 2002/2003 as given by the NORDEL forecast

“European Electricity Market Forecast: Executive Summary”

A forecast for the long-term horizon is the EURELECTRIC “European Electricity Market Forecast: Executive Summary” published in October 1998. It is based on a questionnaire, answered by the

European countries, CENTREL, Switzerland and Norway; the publication does not exactly specify which kind of experts were asked or which kind of database is included. Among others, the document contains forecasts about electricity consumption and generation and maximum installed generation capacity of the countries between the years 2000 and 2010. The predicted import volumes derived from these forecasts are shown in Fig. F.11 for the years 2000 and 2010.

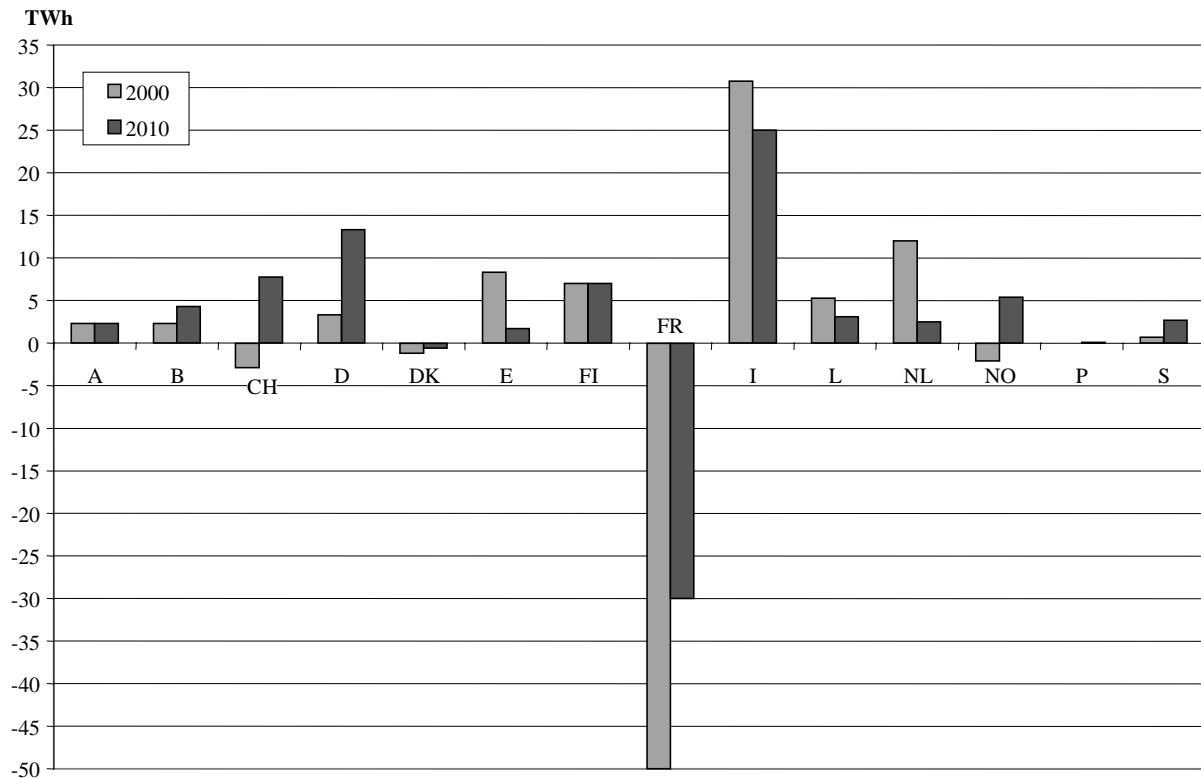

Fig. F.11: Electricity import 2000 and 2010 as given by the EURELECTRIC forecast

“European Union Energy Outlook to 2020”

The “European Union Energy Outlook to 2020” published by the European Commission in November 1999 is one of the long-term forecasts analysed here. This document provides energy forecasts prepared by using different energy system models mainly at the University of Athens within the Shared Analysis Project and in co-operation with the officers of the Unit for Analysis and Forecasts of the Commission. The overall forecast contains, besides information about the development of primary energies and emissions, information about the development of electricity demand, generation and electricity imports (fig. F.12). Regarding generation, installed capacities as well as plant types are taken into consideration. However, predictions on import and export volumes based on this forecast have a very limited accuracy due to the effects of rounding.

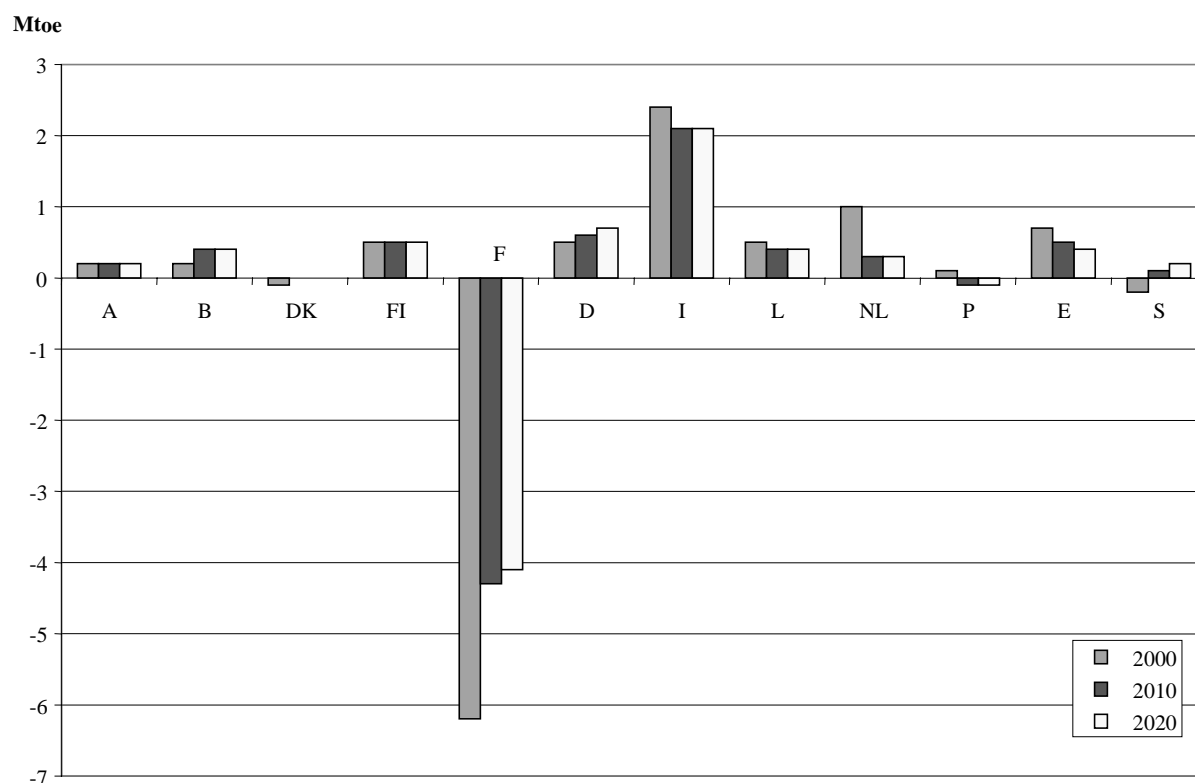

Fig. F.12: Electricity import for 2000, 2010 and 2020 as given by the forecast published by the European Commission (1 Mtoe \approx 11,63 TWh)

Statnett “Annual Report 2000”

One of the analysed TSO documents is the “Annual Report 2000” of Statnett (N). It contains a forecast about the development of electricity demand in Norway of about 300 MW/a in the next years.

Tennet “Capaciteitsplan 2001-2007”

The “Capaciteitsplan 2001-2007” published by TenneT (NL) is another interesting TSO document, because it illustrates the expectations of electricity imports in the next years. These expectations are based on a market study commissioned by TenneT. As a result of this, two different import scenarios (1500 MW and 5000 MW) are considered reasonable by TenneT as a basis for analysing possible network reinforcement projects for the next years.

F.2.3 Results

Border between Norway and Sweden

Regarding Norway and Sweden, the predicted development of load and generation is particularly striking with respect to Norway. In the extreme case, Norway might develop from an exporting to an importing country. While installed generating capacity is expected to remain almost constant in the next years, Norway's electricity demand is expected to increase about 300 MW/a according to Statnett and about 200 MW/a according to NORDEL. Based on the latter prediction, remaining capacity at peak load would thus decrease by approximately 650 MW down to -200 MW in the winter 2002/2003. Sweden's electricity demand is expected to grow only by a total of around 200 MW within three years. Installed generating capacity is estimated by NORDEL to increase only around 60 MW from 2000 to 2003, so that remaining capacity at peak load would decrease around 150 MW in this period, from -981 MW to -1121 MW.

The above-mentioned tendencies are roughly confirmed by the EURELECTRIC and EUROPEAN COMMISSION forecasts, both of which expect that Sweden will import more energy in the future, growing from 0,7 TWh in 2000 to 2,7 TWh in 2010 according to EURELECTRIC. Norway is expected by EURELECTRIC to develop from exporting 2,1 TWh in 2000 to importing about 5,4 TWh in 2010.

In view of the location of the Norwegian network at the edge of the NORDEL system, the cross-border connections between Norway and Sweden on which congestion today occurs in both directions, depending on season and daytime, will mainly be affected by the developments within Norway. As a result of the tendencies derived above, it appears likely that the transmission demand from Sweden to Norway will increase, while decreasing in the opposite direction. This would lead to the congestion from Norway to Sweden being relieved or even totally removed, while congestion from Sweden to Norway would increase. According to the forecasts, the additional lack of transmission capacity could reach a magnitude of up to almost 1 GW at peak load.

Border of West Denmark and Germany

The remaining capacity in West Denmark is expected by NORDEL to decrease slightly (less than 100 MW) in the next three years. This can be derived from a slight growth of electricity demand at peak load (+2,6% of today's load) and stagnating generation capacity. In Germany, electricity demand at reference time "January" is predicted by UCTE to increase around 1100 MW (+1,5% of today's load), whereas installed generating capacity is expected to increase around 2600 MW (+3,1% of to-

day's capacity), so that remaining capacity would increase by approximately 1500 MW to a level of 7100 MW in January 2003.

Taking into account that

- the import demand of Norway and Sweden (see above) is expected to increase by up to 800 MW at peak load,
- Finland's energy balance is predicted to remain almost constant (-59 MW) and only
- East Denmark's remaining capacity is expected to increase by up to 400 MW,

the decrease of remaining capacity in the NORDEL system as a whole would be around 500 MW. Because of the aforementioned developments and the surplus of remaining capacity in Germany, NORDEL expects that West Denmark could become a transit country for electricity from UCTE to NORDEL in the future.

Today congestion on the border between West Denmark and Germany occurs in both directions, but as a result of the tendencies mentioned above, congestion could increase in the direction Germany to Denmark, possibly in the same size as NORDEL's energy balance decreases (around 500 MW at peak load), while the bottleneck from West Denmark to Germany could be relieved or even totally removed.

Borders of the Netherlands

According to the UCTE forecast, the small remaining generation capacity of the Netherlands of today (400 MW in January 2000) is not expected to increase in the next three years. This is based on the prediction that there is a growth of generating capacity around 500 MW from 2001 to 2003, but also an increase of electricity demand around 800 MW at reference time "January" and around 400 MW in "July". The margin of available capacity is expected to remain extremely low in the short term, and as a result of this, imports seems to be substantial. Even TenneT assumes import scenarios up to 5000 MW to estimate necessary network reinforcements, as for example additional phase shifting transformers, to increase network capacity in the short term.

As regards the long-term forecasts, energy imports of the Netherlands are expected to decrease in the next ten to twenty years. EURELECTRIC assumes that these imports will be reduced to 2,5 TWh in the year 2010 (-80% compared to today's imports), and the European Commission forecasts a reduction to around 3,5 TWh in 2010 (-70% compared to today's imports).

It can be summarized that the existing bottleneck at the borders of the Netherlands is expected to remain in the next three years. Maybe it could be slightly intensified in the short term by a few hundred MW, because remaining capacity is predicted to decrease by up to 300 MW in the winter season. In the long run, however, the forecast documents envisage a significant reduction of electricity imports so that the congestion might be completely removed.

Border between France and Spain

The short-term forecasts predict an increase in generation capacity in France of around 2100 MW (+2,6%) at reference time “January 2003” and a decrease in generation capacity of around 1500 MW (-2,2%) at “July 2003”. Taking into account the expected increase of electricity demand (+4,6%), UCTE expects that remaining capacity is reduced to 8500 MW (-14,3%) in January 2003 and to 10100 MW (-28,4%) in July 2003.

As regards the development in Spain, both load and generating capacity are assumed to increase in the next three years. Remaining capacity at reference time is estimated by UCTE at 6300 MW (+23,5%) in “January 2003” and at 5600 MW (+47,4%) in “July 2003”.

The above-mentioned developments are roughly confirmed by the long-term forecasts. However the levels of import by Spain are estimated differently:

- EURELECTRIC predicts that energy imports of Spain will decrease by around 6,6 TWh to 1,7 TWh in 2010, and
- the European Commission estimates a decrease of around 2,3 TWh to 5,8 TWh in 2010.

Regarding exports by France, the long-term forecasts are better in line with each other. Although interestingly EURELECTRIC and European Commission start from different assumptions of the export level for 2000 (EURELECTRIC: 50 TWh; European Commission: around 72 TWh), both expect that France will decrease energy exports by around 20 TWh in the next ten years. This would represent a reduction of 30% to 40% of today’s exports.

Overall, the bottleneck between France and Spain, which occurs mainly in the direction from France to Spain, could disappear through the high increase of available capacity in Spain in the short term. In the view of a predicted increase of remaining generation capacity in Spain of up to 1800 MW and an NTC on this border in the magnitude of 1000 MW, the dominating power flows could even reverse their direction as compared to today. This development seems to be confirmed also by the long-term forecasts.

Borders of Italy

On the one hand Italy is expected to have power plants built, especially in the summer 2003, of around 6600 MW, but on the other hand electricity demand is estimated to increase around 4500 MW in July 2003, so that the remaining capacity is calculated by UCTE to 6600 MW (+10%) for January 2003 and to 5100 MW (+70%) for July 2003.

Regarding the high electricity import demand of Italy today – over 5000 MW – the bottleneck will probably not be removed by these developments, although remaining capacity in July 2003 is expected to grow. However, it appears likely that the bottleneck will at least be gradually relieved, because the predicted increase of available capacity in summer 2003 makes up for approximately 40% of today's import.

The assumed developments for Italy are roughly confirmed by the long-term forecasts. European Commission and EURELECTRIC expect a minor decrease of energy imports: Eurelectric around 5,8 TWh to 25 TWh, and the European Commission around 3,5 TWh.

Border between France and Germany

After the analysis of the aforementioned forecasts, we could not find reasons to believe that the border between France and Germany, which has recently been given much attention by market parties and the European Commission, could become a bottleneck in the near future, especially not in the direction France to Germany. As explained above, the remaining capacity of France is expected by UCTE to decrease in the next years by up to 1500 MW and the available capacity of Germany is estimated to increase by around 2100 MW. Also the long-term forecasts expect a high decrease of energy exports of France. All of these predictions therefore do not support the expectation of a bottleneck emerging from France to Germany.

G Probabilistic approach to derive assumptions for ambient temperatures

G.1 Variation with respect to time of year and time of day

The relation between the power transfer rating of an overhead line and the assumed ambient temperature is shown exemplarily in figure G.1 on the basis of parameters defined by German industry standards, where ambient temperature is assumed not to exceed 35°C. According to this diagram, the relation between rating and temperature is almost linear, with an increase of the rating by approximately 5% for each 5°C of temperature decrease.

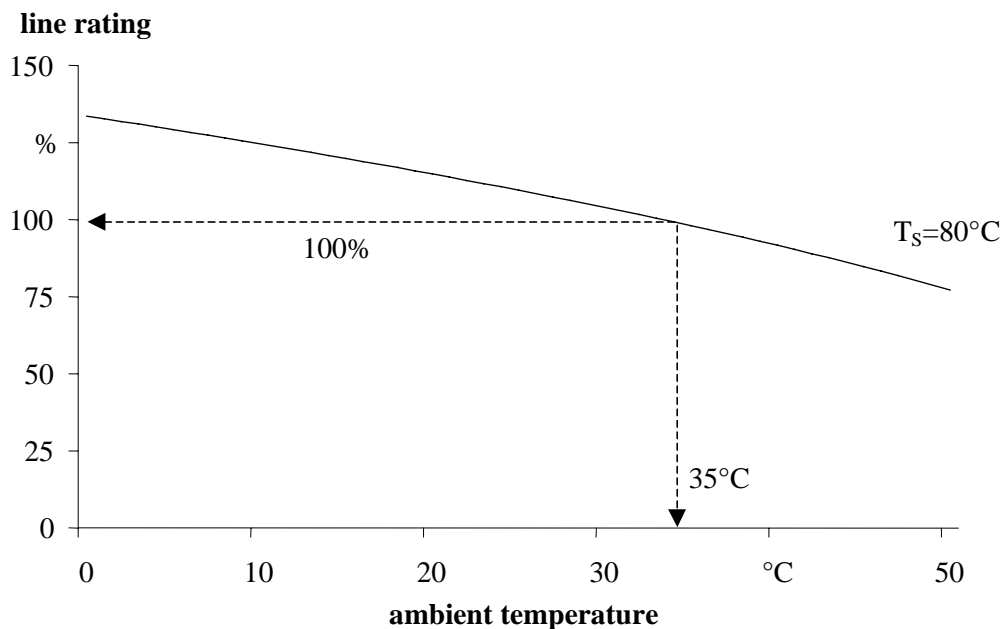

Fig. G.1: Relation between the power transfer rating of a line and the ambient temperature according to German standards, assuming a maximum conductor temperature of $T_S = 80^\circ\text{C}$

Regarding the German example, the assumed ambient temperature of 35°C is obviously only realistic for the hot summer months (June-August), and it will not even be reached every year. On the other hand, this temperature level is also sometimes exceeded, so that this is clearly not a worst case assumption. Rather, a certain probability of “excessive” temperatures is implicitly accepted today. We have tried to quantify this probability by a statistical analysis of comprehensive weather data that we have obtained from a weather station in Aachen. The result of this analysis are the distributions of the highest monthly temperatures for each month of the year shown in table G.1, evaluated over a period of 165 years (1836-2000), and broken down into bands of 5°C width.

°C	Jan.	Feb.	Mar.	Apr.	May	Jun.	Jul.	Aug.	Sep.	Oct.	Nov.	Dec.
0-5	1%	3%	0	0	0	0	0	0	0	0	0	2%
5-10	32%	23%	2%	0	0	0	0	0	0	0	2%	19%
10-15	63%	51%	30%	2%	0	0	0	0	0	4%	44%	70%
15-20	4%	21%	50%	32%	3%	0	0	0	1%	29%	51%	9%
20-25	0	2%	18%	54%	29%	6%	5%	4%	34%	58%	3%	0
25-30	0	0	0	13%	60%	63%	35%	52%	53%	9%	0	0
30-35	0	0	0	0	8%	30%	56%	39%	12%	1%	0	0
35-40	0	0	0	0	0	1%	4%	4%	0	0	0	0

Table G.1: Distributions of highest monthly temperatures in Aachen in the period from 1836 to 2000

According to this table, the probability that the ambient temperature exceeds the threshold of 35°C within a month has its maximum in July and August at a value of 4%. If this probability level were considered acceptable throughout the year, the assumed ambient temperature could be reduced to 30°C in April and October, to 25°C in March, to 20°C in February, November and December, and even to 15°C in January, as indicated by the double line in table G.1. (This argumentation is based on the implicit assumption that the temperature distributions *within* a month, e.g. of the hourly values, are similar in each month when normalised by the monthly maximum temperature. For an in-depth analysis, this assumption should be further investigated on the basis of additional statistical data.)

Similar probabilistic investigations have been done for the temperature difference between day and night, in this case on the basis of data in 10 minute intervals for 1 year from the weather station Sinnenich, located close to Aachen. Figure G.1 shows that daytime temperatures at this weather station are approximately 6°C above those in the night in a summer month, so that an increased line rating could be applied in the night hours. (For winter months, the differences between day and night temperatures appear rather insignificant.)

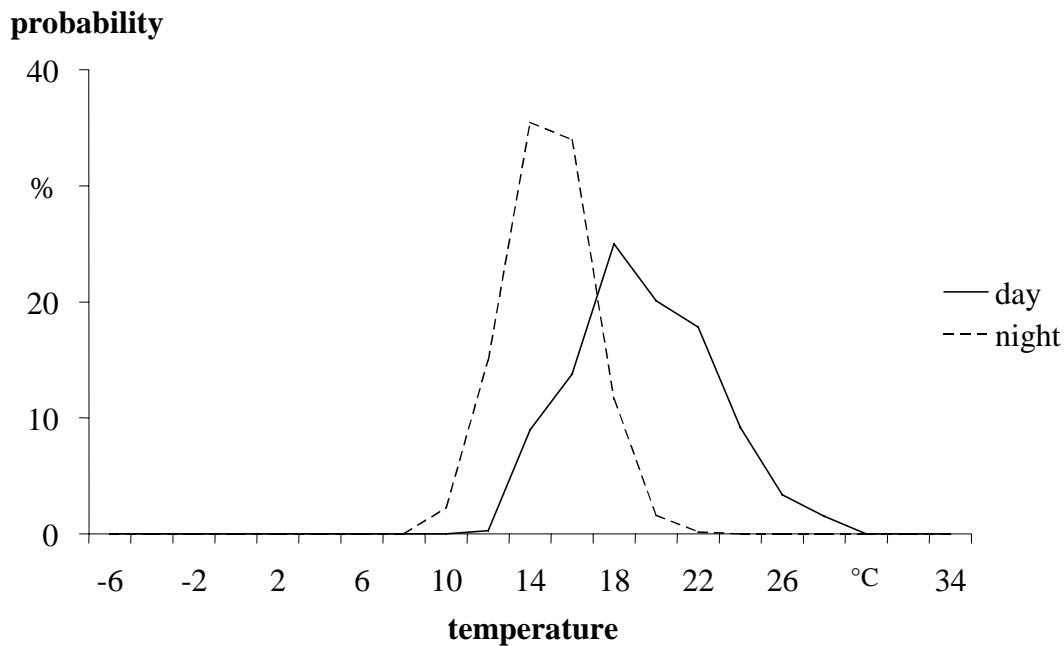

Fig. G.1: Temperature distributions for days (10:00-20:00) and nights in July 2000 in Sinzenich

G.2 Relation between probability of excessive temperature and resulting temperature assumptions

Some TSOs already apply probabilistic analyses in order to derive assumptions on ambient temperatures to be used for capacity assessment. Among these, the accepted level of probability of excessive temperatures varies from 3 % to 12 % for post-fault conditions. As one contribution to the discussion about these thresholds, statistical investigations can be used to quantify the influence of the selected probability on the resulting assumptions for ambient temperatures. An example of such an investigation is described in the following.

Table G.2 shows the distribution of ambient temperature at the Sinzenich weather station near Aachen. The figures are based on data of high resolution (one value every 10 min) of the year 2000¹ and divided by months. The double line and the thick line denote the monthly ambient temperature assumptions that result from a probability threshold for excessive temperature of 1 % and 10 %, respectively.

¹ For a profound study, data of several years would be needed. However, one year's data is enough to demonstrate the principle.

For the given exemplary data, temperature assumptions could be lowered by 5 °C from March to September if a probability of 10 % was accepted.

°C	Jan.	Feb.	Mar.	Apr.	May	Jun.	Jul.	Aug.	Sep.	Oct.	Nov.	Dec.
<0	13.9%	4.3%	0.9%	1.0%	0	0	0	0	0	0	0	10.8%
0-5	56.6%	29.8%	21.4%	11.3%	0	0	0	0	0.0%	0.3%	9.7%	38.5%
5-10	28.8%	53.9%	57.7%	29.6%	10.5%	5.3%	1.0%	0.5%	1.9%	23.7%	67.6%	19.8%
10-15	0.7%	11.7%	18.1%	36.5%	41.2%	27.8%	41.0%	21.1%	40.4%	62.7%	22.7%	30.6%
15-20	0	0.3%	1.8%	13.7%	30.5%	35.9%	43.9%	38.4%	40.8%	12.4%	0.0%	0.4%
20-25	0	0	0	7.5%	11.7%	19.2%	12.9%	30.2%	14.6%	0.9%	0	0
25-30	0	0	0	0.3%	6.1%	7.4%	1.2%	9.1%	2.2%	0	0	0
30-35	0	0	0	0	0	4.4%	0	0.7%	0	0	0	0

Table G.2: Distribution of continuous temperature (10 min intervals)in Sinzenich for each month in the year 2000

H Assumptions on investment and maintenance costs

This appendix section contains the values for investment costs and maintenance cost factors that we have used for the economic assessment of investment measures. Two aspects are important in this context:

- The values shown in the table H.1 are
 - upper limits of values used in several planning studies at the Institute of Power Systems and Power Economics or
 - upper limits of the values given to us by equipment manufacturers or TSOs.

The upper limits were used to avoid an underestimation of the costs for reinforcement projects. Nevertheless it cannot be ensured that in some cases the costs of reinforcement projects might be even higher (e.g. due to topographical difficulties).

- The costs of elements that change the distribution of the load flow (e.g. phase shifting transformers or FACTS) mainly depend on the power they have to steer. The steering power needed to make optimal use of the existing network is a result of individual technical investigations.

equipment	Investment costs c_i	maintenance cost factor
overhead lines		
380 kV double circuit	650,000 Euro/km	1%
380 kV single circuit	450,000 Euro/km	1%
additional circuit (if towers do not have to be reinforced)	150,000 Euro/km	1%
heightening of towers	100,000 Euro/km	0%
shortening of isolators and increasing the tensile stress of conductors	100,000 Euro/km per circuit	0%
switch bay		
110 kV	300,000 Euro	2%
380 kV	1,500,000 Euro	2%
transformer 380/110 kV (300 MVA)	4,000,000 Euro	1%
phase shifting transformers	12,000 Euro/MVA ¹	1%
FACTS that change the distribution of the load-flow (e.g. UPFC)	150,000 Euro/MVA ¹	
capacitor banks	4,000 Euro/Mvar	
FACTS that provide reactive power (e.g. SVC)	80,000 Euro/Mvar	

Table H.1: Values used for cost estimation of reinforcement projects

¹ To transform the specific costs to investment costs, the value has to be multiplied with the steering power of the equipment.

I Load flow based investigations

I.1 Overview and data base

In order to substantiate our analysis of certain aspects of the study, we have carried out load flow simulations based on input data which have been provided by ETSO. Particularly, we have analysed

- the “network density” on the borders and within the national systems which contributes to the investigations on the demand for transmission capacity (cf. chapter 5), and
- the amount of additional cross-border transmission capacity that could be obtained by implementing possible “soft measures” or network reinforcement options.

As input data for our simulations, we have received from ETSO on 5 October 2001 the common UCTE load flow forecasts for January 1999, 2000 and 2001. Because of legal restrictions within the Nordic countries, it was not possible to be granted permission to use any similar data from the NORDEL interconnection. (Such data would have been of limited use anyway, because the critical phenomenon for cross-border transmission capacity in NORDEL is mostly stability which cannot be analysed with load flow data.)

Originally, we had planned to use the load flow simulations to prepare and support the discussion process with the TSOs during the course of the study. However, since we received the data only shortly before the submission of this report, we had to narrow and simplify our analysis, and a detailed technical discussion of the results with TSOs has not been possible. In particular, it has not been possible to perform analyses of situations other than the winter peak load case of 2001. We have used the provided load flow data set as is, with the exception of the Italian tie lines to France and Switzerland whose current limits we have adjusted according to information from GRTN (I) about recent agreements between them and the neighbouring TSOs.

The methodologies applied and the analysis results obtained are presented in the following sections.

I.2 Determination of network density

I.2.1 Algorithm

As explained in section 5.7, we have developed an algorithm that calculates the “(n-1) secure point-to-point transmission capacity” of a network as seen from the location of each single line, in order to obtain a quantity for the network density within countries and on border sections that does not depend on sizes and locations of the countries.

The (n-1) secure point-to-point capacity is defined as the maximum amount of power which theoretically could be transported between the two terminal stations of a line when starting from an “empty” network. It is important to stress again that this value is something completely different from NTC values for two reasons. Firstly, NTC values are integral values for the capacity across a complete border section, whereas the point-to-point capacities can rather be considered density values calculated for a specific location. Secondly, the latter values are – in contrast to NTCs – calculated for an empty network status, so that they merely reflect properties of the network elements (i.e. lines and transformers) and the network structure (i.e. topology and switching status) in the region around the considered line.

To achieve a uniform and simple approach, we assume that at the location of a line, the outage of that precise line is the most critical contingency in terms of (n-1) security. Hence, the (n-1) secure point-to-point capacity at the location of a line can be defined as the maximum power P_{max} which can be transported between the two substations at the ends of the line without violating current limits of other lines or transformers, under the condition that the respective line itself is switched off. (Note that for double circuit lines only one circuit is switched off.)

To calculate P_{max} the regarded line is eliminated from the network model, a source and a sink of equal power are connected to its nodes, and a linear load-flow calculation is performed (fig. I.1).

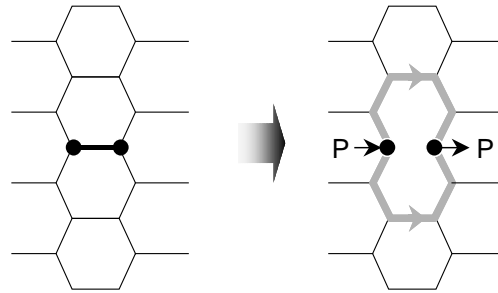

Fig. I.1: Principle of determining (n-1) secure point-to-point capacity

Based on the load flow calculation, a factor can be derived for each branch j of the surrounding network that represents that part of the power transfer P between the two nodes that flows across the branch j . These factors are commonly known as Power Transfer Distribution Factor (PTDF):

$$PTDF_j = \frac{P_j}{P}$$

Knowing these factors and the thermal current limits $I_{max,j}$ of all lines, the level of power transfer P that leads to a full (100 %) loading of a line j can be calculated for each line. (Note that the maximum current can be transformed into a maximum power flow by multiplying it with $\sqrt{3}$ and the nominal voltage $U_{n,j}$, i.e. 220 kV or 380 kV, whereby reactive power flows are neglected for simplicity). The (n-1) secure point-to-point capacity P_{max} is then the lowest admissible power flow for all regarded lines:

$$P_{max} = \min_j \left(\frac{\sqrt{3} \cdot U_{n,j} \cdot I_{max,j}}{PTDF_j} \right)$$

After calculating P_{max} for each individual line of the network, average values of these quantities are computed for each country's internal lines and for the tie-lines of each border section.

I.2.2 Results

We have carried out calculations as described above for all the 380 kV and 220 kV lines contained in the UCTE network model that we have received. The country- and border-related averages of the resulting network density values are listed in tables I.1 and I.2 for 380 kV and 220 kV separately. For the figure shown in section 5.7, the respective values for these two voltage levels have been added because the results for different voltage levels can roughly be considered independent from each other. (Of course, this is only an approximation, but it should be kept in mind that this approach is anyway intended to yield a rough overview of network density, and not precise quantities that can be compared to actual NTC values.)

	A	B	CH	D	E	F	I	NL	P
A	2043								
B		1413							
CH	1095		1677						
D	1861		1474	1744					
E					1864				
F		1877	1922	1876	907	2497			
I			979			1645/1053 ¹	1564		
NL		1291		1800				2529	
P					1183				1730

Table I.1: Average (n-1) secure point-to-point capacities in MW for 380 kV lines

	A	B	CH	D	E	F	I	NL	P
A	408								
B		276							
CH	332		332						
D	404		363	338					
E					286				
F		231	404	358	193	272			
I	151		241			162	201		
NL								607	
P					273				317

Table I.2: Average (n-1) secure point-to-point capacities in MW for 220 kV lines

¹ Reduced value if (n-2) criterion is applied for 380 kV double circuit line Albertville-Rondissone. For the diagram in section 5.7, the higher value based on the (n-1) criterion has been applied.

I.3 Measures to increase transmission capacity

I.3.1 Methodology

Using a simulation tool developed at the Institute of Power Systems and Power Economics, we have investigated the effect of “soft measures” and network reinforcement options on the transmission capacity over three of the five borders that have been identified as the most critical ones in chapter 4. The restriction to three borders is caused by the fact that no load flow data was available for the borders between Sweden and Norway (inner-NORDEL border) and between Germany and Denmark (UCTE-NORDEL border).

Our network analysis tool obtains its results by simulating the TTC assessment procedure in a simplified manner. This implies

- a simulation of power transfers between adjacent countries by means of stepwise increased generation shifts²; generator output is modified proportional to the base case generation dispatch³;
- a security analysis at each transfer step, i.e. a simulation of contingencies of network elements and generators; and
- a subsequent check – for the pre-fault as well as all post-fault situations – if any currents in the network are beyond their respective limits; i.e. that overload of tie lines as well as internal lines or transformers is recognised.

The transmission capacity is reached when the first current limit is exceeded.

(In principle, the tool is also capable of checking steady-state voltage limits. However, there seemed to be a significant lack of reactive power especially in the peripheral regions of the provided load flow

² At each step the power transfer is increased by 100 MW. Given the accuracy limitations of the input data as well as the simulation model, we consider this a reasonable lower bound for any serious statements on capacity changes.

³ The maximum capacity of generators has not been taken into account because this information is not included in the UCTE load flow file. Besides, the generation shift according to a merit order as applied by some TSOs could not be simulated due to unavailability of the respective input data.

model. Hence, reactive power supply of generators had to be considered unlimited⁴ to avoid convergence problems. Consequently, the simulation tool might not recognise actual voltage problems because of unrealistically high regional reactive power support. When discussing the simulation results, we will however mention the eventual need for increased reactive power supply in cases where the TSOs have referred to steady-state voltage problems.)

In order to adequately simulate the individual TSOs' security assessment procedures, most relevant parameters like selection of contingencies to be considered, post-fault line or transformer overload limits etc. have been modelled individually for each country. Feasibility checking of post-fault corrective measures have, where applicable, been done manually for sample cases.

The application of "soft measures" has mainly been simulated by increasing pre-fault and/or post-fault current limits or by modifying the selection of contingencies. In the former case, current limits for all lines within a TSO's area have been adjusted proportionally.

We have simulated network reinforcement measures by inserting new lines and/or transformers in the load flow model. Where not known explicitly, we have used typical values to model the electrical properties of new network elements.

Our investigations have essentially been of an "incremental" nature: our aim was to roughly quantify the additional capacities that would be obtained by individual soft or investment measures. A combined implementation of several measures has only been investigated when their usefulness obviously depends on each other. We believe that an analysis of numerous subsequently applied measures could only be serious if based on more comprehensive input data (e.g. a variety of scenarios) and more precise modelling (e.g. with respect to a realistic representation of large generation shifts) than what has been possible within the framework of this study.

When analysing the effects of the investigated reinforcement measures, we sometimes refer to the "power transfer distribution factor" (PTDF) whose meaning has already been illustrated in section I.2.1. In contrast to there, the PTDFs referred to on the following pages are always determined by AC incremental load flow at the respective base case operating point of the power system and therefore more accurately reflect the actual system behaviour. The PTDF figures are always related to the same transfer direction which the capacity increase is to be investigated for. (For example, when investigat-

⁴ Technically, this is done by suppressing "PV to PQ conversion" in the load flow algorithm.

ing the increase of transmission capacity from France to Italy, the mentioned PTDF figures are indicating which percentage of an additional France-to-Italy power transfer flows on certain network elements.)

In addition to the transmission capacity gain of each measure we have calculated the incremental losses for two operating conditions:

- Without modifying the amounts of international power transfer, the mere installation of a new network element leads to a change of the losses which can be either positive or negative⁵. Regarding the economic assessment of reinforcement projects, we consider these incremental losses an integral part of the project costs.
- After increasing the transmission capacity either by soft or reinforcement measures, the market players will try to benefit from this and utilise the new capacity. This leads to a higher loading of network elements and therefore increases the level of losses. Regarding the economic welfare evaluation of measures, this must be considered as a reduction of the overall benefit which is achieved on the generation side.

The loss determination is of limited accuracy because it is – as the TTC assessment itself – based on the assumption that only generators in the two countries adjacent to the regarded border benefit from the capacity increase. Moreover, it only considers one specific (peak load) network situation. Nevertheless, it allows for a rough estimation of incremental loss costs as a contribution to the economical assessment described in section 7.2.

It is clear that due to several limitations of the simulation method as well as the input data our investigations must not be considered a replacement for more thorough studies by the TSOs which are essential before implementing any of the discussed measures⁶. Nevertheless we have, wherever possible, verified the plausibility of our results by comparing them to TSOs' statements concerning relevant

⁵ When installing phase shifting transformers, we have already in the base case set the tap to the position which gives the optimal transmission capacity. Regarding the losses, this can be considered a safe estimation, because it means that in case of a contingency no further tap adjustment is necessary to avoid overloading.

⁶ In particular, a comprehensive technical evaluation of a network reinforcement project would cover on the one hand more than one base case load flow situation and on the other hand evaluation criteria beyond the mere extension of a cross-border transmission capacity according to a specified definition.

physical effects or critical network situations at their respective borders. In cases where obviously unrealistic effects have influenced the transmission capacity we have slightly adapted the models to achieve more plausible results. While these limitations should be kept in mind when evaluating the mere figures in the following subsections, we are convinced that the investigations are in most cases relevant enough to allow for conclusions regarding a ranking of different reinforcement projects or the general usefulness of soft measures at certain bottlenecks. (Note that such conclusions are however not drawn in this appendix, but in chapter 8 under consideration of all relevant aspects, whereas the results in the following subsections – being one contribution to those considerations – are of a purely technical nature.)

I.3.2 France/Switzerland/Austria/(Slovenia) → Italy

(Note: Two maps illustrating the investigated measures at this border can be found as fig. 8.1 and 8.2 on pages 92 and 94 of the main part of this report.)

Base case situation

In principle, a power transfer through AC networks affects every network element. At the Italian border however, two sections can be considered practically independently from each other:

- Import flows at the western borders to France and Switzerland are dominated by import from France, about 43 % of which flow through the direct French-Italian tie lines, while another 47 % are transited by Switzerland. Since France is the major source of low-priced generation surplus in that region, we have decided to evaluate possible measures with respect to their influence on the transmission capacity from France to Italy if they affect France, Switzerland and/or internal Italian matters. In the base case, this capacity is most limited by the simultaneous double circuit outage of the tie line Albertville-Rondissone leading to thermal overload on the French part of the tie line section between Albertville (F) and Piosasco (I).

Another reason for choosing the France-to-Italy capacity was that the base case was heavily pre-loaded at the French-Italian border. This does probably not inadmissibly influence our investigation results, because they only refer to incremental capacity figures. However, an increase of the Swiss-to-Italy capacity would probably have first required a reinforcement between France and Italy. Swiss TSOs have pointed out that they discourage the use of the forecast load flow situation and recommend to use the snapshot instead. This or, alternatively, the negotiation of an adapted scenario, was however not possible within the short time frame for our load flow based investigations. Nevertheless, it should be noted that the benefit of the investigated measures may be biased and neglect additional power transmission opportunities from Switzerland.

- In the eastern section, the interconnection between Italy and Austria is very weak, so that import to Italy mainly crosses the border to Slovenia which is however outside the scope of this study. Moreover, the most important exporters in that region are probably the CENTREL countries which are not considered either. Although the base case shows that critical conditions can occur at the eastern border section (a fact which has also been underlined by GRTN (I) and APG (A)), we could only perform limited investigations of possible countermeasures. In particular, we have regarded measures at the Austrian-Italian border and their effect on the transmission capacity between Austria and Italy.

Soft measures on western border section (France/Switzerland/Italy)

The following soft measures have been considered for the western border section:

1. Capacity from France to Italy is, as mentioned above, limited by the (n-2) failure of the double circuit tie line Albertville-Rondissone. If **only the (n-1) failure of a single circuit** was considered instead, the transmission capacity could be increased by **900 MW**. The critical network element which limits the power transfer would in this case be a 220 kV line inside Italy (Ospiate-Torretta) being overloaded after the failure of the 380 kV line Bovisio-Ospiate.
2. Regarding possible soft measures related to increased thermal currents, short-term overloading of lines is presently considered by RTE (F), Swiss TSOs/ETRANS and GRTN (I), and seasonal variation of ambient temperature is applied for the French-Italian and Swiss-Italian tie lines as well as for internal French and Swiss lines. Therefore, the only remaining option is the **increase of thermal current limits of internal Italian lines in winter**. This makes however only sense if the (n-2) criterion for the tie line Albertville-Rondissone is reduced to (n-1), because only in this case the critical line is inside Italy (see measure 1 above). It turns out that under this condition a current limit increase of 5 % would lead to **200 MW** more import capacity. Further increased thermal limits inside Italy would have no effect because the critical line would then again be the French part of the tie line section between Albertville (F) and Piossasco (I) (cf. base case situation above).

Network reinforcement on western border section (France/Switzerland/Italy)

For the evaluation of reinforcement projects, the original security criterion has been restored to the present practice, i.e. (n-2) failures of double circuit tie lines have been taken into account. We have analysed the following projects:

3. Installation of a **phase shifting transformer in La Praz (F)**

This transformer would be used to prevent the weakest 380 kV tie line between France and Italy (Albertville-La Praz-Villarodin-Venaus-Pioassasco) from being overloaded by shifting the power flows towards Switzerland. This shift already takes place in the base case: with constant Italian import, the power flow on the weak Albertville-Pioassasco connection is reduced by 320 MW, of which the double circuit line Albertville-Rondissone takes about 160 MW while the rest is distributed almost equally to the 220 kV and 380 kV tie lines from Switzerland to Italy. (Note that the distribution of *additional* transfer from France to Italy on the individual lines – i.e. the PTDF values – is practically not affected by the phase shifter.) The resulting “equalised” line loadings allow for an additional transmission capacity of 700 MW.

Further import would then be limited by two internal Italian 220 kV lines, one in the Turin area (Avisse-Quart) and one near Milan (Ospiate-Torretta). If we assume that the post-fault overloading of these lines could be avoided or tolerated⁷, the phase shifter would lead to an even higher capacity increase of **1600 MW**⁸. The first overloaded line would in this case be the Baggio-Ospiate connection in the Italian 380 kV grid.

For all following reinforcement projects on the western border section, we have assumed that the two mentioned 220 kV lines are not considered critical.

⁷ One could for example accept a follow-up tripping of these lines after occurrence of the critical failure in the 380 kV grid. Such tripping would not lead to any supply interruption. However, some 220 kV substations would be supplied from only one instead of two lines until the restoration of the original switching status in the 380 kV grid. According to GRTN, this procedure would be acceptable.

⁸ At a first glance this amount of 1600 MW additional import capacity might seem astonishingly high. An estimation of the maximum theoretical capacity gain may however underline that this amount is not beyond credibility. The critical tie-line Albertville-Pioassasco has a PTDF of 13 %, i.e. 13 % of a France-to-Italy power transfer flow over this line. By installing the phase shifting transformer, the flow on this line is reduced by 320 MW. Under the ideal assumption that no other network element becomes more critical, this would yield an additional capacity of $320 \text{ MW} : 13 \% = 2400 \text{ MW}$. Our analysis shows that in fact the Baggio-Ospiate line inside Italy becomes the most critical element, so that the ideal potential of the transformer cannot be fully utilised.

4. Construction of a new **double circuit 380 kV tie line between Grande Île (F) and Piossasco (I)**

This new line would serve as a backup for the existing double circuit tie line Albertville-Rondissone, allowing for a transmission capacity increase of **1400 MW**. As a result of the reinforcement, the tie lines would become stronger than the internal Italian 380 kV grid. Again the line Baggio-Ospiate would be the most critical one.

It might seem illogical that the construction of a new line yields less capacity gain than the installation of a phase shifter in the same area (1400 instead of 1600 MW). In order to comprehend the difference one must note that even in undisturbed operation, the new tie line has the effect that a larger percentage of the France-to-Italy power transfer (49 % compared to 43 %) crosses the French-Italian border. This increases the loading (from 960 to 1033 MW) as well as the PTDF (from 8 % to 10 %) of the critical Italian 380 kV line Baggio-Ospiate. Consequently, this line is overloaded earlier than after installation of the phase shifter.

For all following reinforcement projects on the western border section, we have to assume that the phase shifting transformer in La Praz is installed first, because otherwise the critical French line in the Albertville-Piossasco interconnection would prevent any reinforcement project from bringing a capacity gain.

5. Installation of a **phase shifting transformer in La Praz (F)** and construction of a **single circuit 380 kV line between Chippis (CH) and Airolo (CH)**, a **380 kV double circuit tie line between Airolo (CH) and Turbigo (I)** and a **380 kV single line between Turbigo (I) and Ospiate (I)**

After installation of the phase shifter, all three other projects must be realised in combination in order to significantly increase the transmission capacity. The achievable capacity gain is **2400 MW**, i.e. 800 MW more than the phase shifter alone.

As a result of the reinforcement, the power flow in west-to-east direction through the Swiss transmission grid is increased by about 650 MW, while the PTDF of the French-Italian border is decreased from 43 % to 39 %. The most critical network section is now between Genissiat (F) and Chamoson (CH) in the Lake Lemman area. The flow on the 380 kV connection between these substations is increased by 250 MW while the 220 kV lines have to transport additional 180 MW. One of these 220 kV lines, the inner-Swiss connection Batiáz-Riddes, becomes the limiting element which is overloaded after the outage of the Albertville-Rondissone tie line.

The construction of the inner-Italian line from Turbigo to Ospiate is necessary in this context, because in the first place it reduces the loading on the almost parallel line Turbigo-Baggio and consequently also on the most critical Italian line Baggio-Ospiate by more than 300 MW. Even more

important is that the strengthening of the western connection to Milan helps significantly to withstand the outage of one of the northern connections of the city.

6. Installation of a **phase shifting transformer in La Praz (F)** and construction of a **new double circuit 380 kV tie line between Robbia (CH) and San Fiorano (I)**

The new tie line between Switzerland and Italy attracts about one fifth of the France-to-Italy transfer (PTDF = 19 %), thereby increasing the power flow through the strong 380 kV grid inside Switzerland. This significantly relieves the loading of the Swiss north-to-south axis from Mettlen to Lavorgo (PTDF decreases from 10 % to 7 %), but has practically no positive effect on the weak 220 kV connection between Chippis and Airolo (PTDF changes only from 5.7 % to 5.3 %). Consequently, with increased power transfer, in this section the first overload occurs.

Nevertheless, the capacity gain from these measures is **2000 MW**, i.e. 400 MW more than the phase shifter alone. The main reason for this additional capacity is that due to the shift of power flows inside Switzerland the tie line Lavorgo-Roncovalgrande is relieved (PTDF reduction from 15 % to 11 %) which also decreases the loading of the critical northern connection to Milan.

Although the **additional construction of a 380 kV line from Chippis (CH) to Airolo (CH)** is not necessary to achieve a transmission capacity gain, we have also considered this variant because it might allow a fairer comparison to the previous project. This combination of now three reinforcements yields an additional transmission capacity of **2700 MW**, i.e. 1100 MW more than the phase shifter alone.

Table I.3 shows a summary of the investigated measures for the eastern border section including their influence on the loss level.

#	Measure	Additional cross-border transmission capacity [MW]	Additional peak load losses after implementation [MW]	Resulting additional peak load losses after full use of new capacity [MW]
1	(n-1) instead of (n-2) assessment for Albertville-Rondissone tie line	900	0	23
2	#1 plus increase of internal Italian current limits by 5 %	1100	0	33
3	phase shifting transf. in La Praz (F)	1600	15	73
4	double circuit 380 kV tie line from Grande Île (F) to Piosasco (I)	1400	-22	15
5	#3 plus single circuit 380 kV line Chippis (CH) to Airolo (CH), 380 kV double circuit tie line Airolo (CH) to Turbigo (I) and 380 kV single line Turbigo (I) to Ospiate (I)	2400	-10	86
6	#3 plus double circuit 380 kV tie line Robbia (CH) to San Fiorano (I)	2000	7	75
	plus single circuit 380 kV line Chippis (CH) to Airolo (CH)	2700	-6	104

Table I.3: Impact of investigated reinforcement projects at the eastern section of the Italian borders on transmission capacity and losses

Soft measures on eastern border section (Austria/Italy)

So far, APG (A) does not consider a seasonal variation of ambient temperatures nor short-term overloading of lines or transformers. Therefore, a potential soft measure is

1. to increase current limits in Austria and for the Austrian-Italian tie line. We have simulated a **current limit increase of 10 %**. (From the technical point of view it is irrelevant if this limit is increased for normal operation – i.e. because of lower ambient temperatures in winter – or for (n-1) situations only. Besides, only the tie line limit needs to be increased because there are no internal bottlenecks relevant for this transfer direction and amount.) This measure would yield an additional transmission capacity of **200 MW** from Austria to Italy. We did not investigate higher thermal current ratings because after the 200 MW gain, the capacity limit is set by critical loading of Italian lines close to the Slovenian border which we could not study in more detail.

Network reinforcement on eastern border section (Austria/Italy)

At the Austrian-Italian border, the following project has been analysed:

2. Construction of a **new single circuit 380 kV tie line from Lienz (A) to Cordignano (I)**

The additional transmission capacity due to this project is limited by the 220 kV tie line from Lienz (A) to Soverzene (I) which is the first line to be overloaded if the new line to Cordignano fails. However, the transmission capacity could be increased by **600 MW**.

Table I.4 shows a summary of the investigated measures for the eastern border section including their influence on the loss level.

#	Measure	Additional cross-border transmission capacity [MW]	Additional peak load losses after implementation [MW]	Resulting additional peak load losses after full use of new capacity [MW]
1	current limit increase of 10 % on Austrian-Italian tie line	200	0	9
2	new single circuit 380 kV tie line from Lienz (A) to Cordignano (I)	600	-19	3

Table I.4: Impact of investigated measures at the Austrian-Italian border on transmission capacity and losses

I.3.3 Germany → Netherlands & France → Belgium/Netherlands

(Note: A map illustrating the investigated measures at this border can be found as fig. 8.4 on page 105 of the main part of this report.)

Base case situation

Following the regulations regarding the present capacity allocation procedure, allocable import capacity to the Netherlands is determined by TenneT (NL) regardless of the power source. Taking into account the also critical southern Belgian border and trying to analyse technical transmission capacities independently from the actual allocation method, we have decided to investigate three different incremental transmission capacities:

- from Germany to the Netherlands,
- from France to Belgium and the Netherlands⁹, and
- from France to the Netherlands¹⁰.

For power transfer from Germany to the Netherlands, the critical contingency is the outage of one of the two “Selfkant” tie line circuits from Rommerskirchen/Siersdorf (D) to Maasbracht (NL) followed by an overload of the parallel system.

Import from France to Belgium and the Netherlands or only to the Netherlands is most limited by the French-German tie line from Vigy (F) to Uchtelfangen (D) where a failure leads to overloading of the parallel circuit. The main difference between the two scenarios is that the PTDF of this critical line (and, consequently, of the German network as such) is higher if only the Netherlands are considered as sink. For power transfer to Belgium and the Netherlands, the French-Belgian tie lines are closer to their thermal limits.

We have been informed by TenneT that the voltage profile in southern Netherlands is sometimes relatively low and may become critical when imports are increased. Therefore, some or all of the measures which are discussed below might require the additional installation of reactive power sources (e.g. shunt capacitors) in the Dutch network. We could however not explicitly investigate this question due to the limitations of the provided network model (cf. section I.3.1).

Soft measures

Both ELIA (B) and RTE (F) consider seasonally variable thermal currents as well as a significant percentage of short-term post-failure overload (20-35 %). TenneT allows 10 % overload but no current increase during cold seasons. In Germany, about 5 % of overload are tolerated, and current limits are

⁹ The distribution between Belgium and the Netherlands has been done proportional to the base case generation, so that each country imports about half of the additional French exports.

¹⁰ Some of these capacities are formally not in line with the ETSO procedures declaring capacities between adjacent countries only. On the other hand, we consider them realistic cases taking into account the location of obvious high and low price areas. Moreover, they are similar to one of the scenarios which are considered during import capacity assessment by TenneT and their neighbours, where the power source is also located in France [7].

also constant throughout the year. Consequently, the soft measure to be investigated is the increase in current limits for the German and Dutch networks.

1. When **(n-1) overload limits in Germany are raised to 10 %**, transmission capacity from Germany to the Netherlands could be increased by **600 MW**. (Note that this measure is **equivalent to an increase of (n-0) current limits of 10 %** by considering the seasonal variation of ambient temperature.) The “Selfkant” tie lines to Maasbracht would remain the critical contingency.

If **(n-1) overload limits in Germany and the Netherlands are raised to 20 % (equivalent to an increase of (n-0) limits by 20 %)**, the additional capacity from Germany to the Netherlands would be **1000 MW**; in this case, both the “Selfkant” tie lines (after an outage) and the phase shifting transformer in Gronau (in normal operation) would reach their transfer limits;

A combined increase of (n-0) and (n-1) limits would lead to a relative increase of (n-1) limits by more than 20 % compared to the base case. Due to the constant rating of the Gronau phase shifter (in the Germany to Netherlands case) and the limiting capacity of the French 220 kV grid (in the France to Belgium and Netherlands case), such a measure would not yield any additional transmission capacity gain.

2. By **opening the bus bar coupling in Uchtelfangen (D)** – either constantly or only in case of an overloading of the Vigy-Uchtelfangen tie line – transmission capacity
 - from France to Belgium and the Netherlands could be increased by **100 MW** and
 - from France to the Netherlands could be increased by **500 MW**.

The effect of this measure is caused by an impedance increase of the French-German interconnection after failure of one of the two critical circuits. The capacity gain in the first case is lower because the measure would lead to a higher loading of the French-Belgian tie lines. Therefore, Lonny-Achène would become the critical outage leading to an overload of the Moulaine-Aubange 220 kV tie line. For power transfers from France to the Netherlands, the tie line Vigy-Uchtelfangen would remain the most critical element, i.e. that the potential of the measure can be fully exploited.

Network reinforcement

We have investigated the following reinforcement projects:

3. **Upgrade of the tie line from Vigy (F) to Uchtelfangen (D) to 2100 kA maximum current**

This measure directly affects the most critical line for power transfer from France to either the Netherlands or Belgium and the Netherlands. Transmission capacity from France to the Netherlands could be increased by **700 MW** (with critical overload being in the French 220 kV grid near

Moulaine), while transports to Belgium and the Netherlands would only benefit by **100 MW** due to the higher pre-load of the French-Belgian tie lines.

4. Upgrade of the tie line from Moulaine (F) to Aubange (B) from 220 kV to 380 kV

In the base case the Moulaine station has already 380 kV connections, but no 380/220 kV transformer. Hence the cross-border power flow to Aubange must be transported through the French 220 kV grid. After the upgrade of the tie line to 380 kV, the 220 kV grid is practically not used for the cross-border transfer any more. Instead, the 380 kV lines from Lonny (F) and Vigy (F) to Moulaine take over the function of feeding the tie line to Aubange. Unfortunately, the reinforcements relieves the uncritical tie line Lonny-Achène-Gramme (PTDF decrease by 3 %) more effectively than the critical tie line Vigy-Uchtelfangen (PTDF decrease by 1.3 %). Nevertheless, the transmission capacity from France to Belgium and the Netherlands can be increased by **1200 MW**. Regarding power transfers from France to the Netherlands, the PTDF of the Vigy-Uchtelfangen line is only decreased by 0.5 %, so that additional capacity for this scenario would be only **400 MW**.

5. Installation of a second circuit between Avelin (F) and Avelgem (B)

As the reinforced line is not congested in the base case, its benefit is only caused by the decreased impedance, which attracts more power flow to this interconnection (PTDF for transport from France to Belgium and the Netherlands is increased by 3.7 %). Obviously, this additional loading relieves the electrically closer 380 kV tie lines Lonny-Achène-Gramme and Vigy-Uchtelfangen more than the 220 kV tie line Moulaine-Aubange whose PTDF is decreased by only 0.3 % (plus a base case power flow decrease of 10 MW). Since Moulaine-Aubange is however the most critical line for transfer from France to Belgium and the Netherlands, the respective capacity gain from the reinforcement is only **200 MW**. Capacity from France to the Netherlands benefits from the slightly stronger PTDF decrease of the critical line Vigy-Uchtelfangen and can be increased by **300 MW**.

6. Installation of a second circuit between Lonny (F) and Gramme (B)

Qualitatively speaking, this reinforcement creates similar effects than project 5 above. However, at least for power transfer from France to Belgium and the Netherlands, Lonny-Gramme is closer to the critical Moulaine-Aubange interconnection and therefore leads to a stronger PTDF reduction (1.6 % compared to 0.3 %) and a stronger relief in the base case (minus 30 MW compared to minus 10 MW). The resulting transmission capacity gain of **1100 MW** is therefore much higher. As regards the capacity from France to the Netherlands, the relieving effect on the critical line Vigy-Uchtelfangen is practically identical with project 5; thus, the same capacity gain of **300 MW** can be achieved.

7. Installation of two phase shifting transformers in Meeden (NL)

As already experienced for the phase shifting transformer at the French-Italian border, also the phase shifting transformers in Meeden have no impact on the distribution of additional load flows, i.e. the PTDF values remain constant. The phase shifter only changes the base case load flow in order to equalise the line loads. Since the tie lines from Germany to Meeden are loaded rather weakly in the base case, the transformers are used to attract power flow. In fact, about 550 MW can be moved to the Diele/Conneforde-Meeden interconnection. This relieves the critical “Selfkant” lines from Germany to Maasbracht by 150 MW. Consequently, transmission capacity from Germany to the Netherlands can be increased by **700 MW** with the “Selfkant” tie lines remaining as critical elements.

Table I.5 shows a summary of the investigated measures for the borders between France, Belgium, Germany and the Netherlands including their influence on the loss level.

#	Measure	Additional cross-border transmission capacity [MW]	Additional peak load losses after implementation [MW]	Resulting additional peak load losses after full use of new capacity [MW]
1	increase of thermal currents – (n-0) or (n-1) – in Germany and the Netherlands by 10/20 %	600/1000 (D→NL)	0	31/50 (D→NL)
2	opening the bus bar coupling in Uchtelfangen (D)	100 (F→B+NL) 500 (F→NL)	0	3 (F→B+NL) 34 (F→NL)
3	Upgrade of the tie line from Vigy (F) to Uchtelfangen (D) to 2100 kA maximum current	100 (F→B+NL) 700 (F→NL)	-2	3 (F→B+NL) 56 (F→NL)
4	Upgrade of the tie line from Moulaine (F) to Aubange (B) from 220 kV to 380 kV	1200 (F→B+NL) 400 (F→NL)	-12	62 (F→B+NL) 17 (F→NL)
5	second circuit between Avelin (F) and Avelgem (B)	200 (F→B+NL) 300 (F→NL)	-2	8 (F→B+NL) 20 (F→NL)
6	second circuit between Lonny (F) and Gramme (B)	1100 (F→B+NL) 300 (F→NL)	-1	69 (F→B+NL) 22 (F→NL)
7	two phase shifting transformers in Meeden (NL)	700 (D→NL)	6	40

Table I.5: Impact of investigated measures at the French-Belgian and German-Dutch borders on transmission capacity and losses

I.3.4 France → Spain

(Note: A map illustrating the investigated measures at this border can be found as fig. 8.5 on page 110 of the main part of this report.)

Base case situation

When the present assessment rules and limits are applied to the base case, power transfer from France to Spain is limited by the overload of a 380/220 kV transformer in Vic (E) after the outage of the internal Spanish 380 kV line from Pierola to Vic.

(REE (E) has stated that the critical condition in peak-load situations is too low voltage in the Juia/Bescano area after a power plant outage. Due to the limitations of the provided load flow model (cf. section I.3.1) we could not simulate this effect. Therefore, additional reactive power sources might be necessary in addition to any of the measures discussed below. An exception is the new connection Baixas-Bescano-Sentmenat which provides additional reactive power support to the critical region.)

Soft measures

Both REE (E) and RTE (F) consider a seasonal variation of thermal current limits and allow short-term overloading of lines after failures. The latter does (in the case of REE) however not apply to the tie lines. Hence, the only potential soft measure to be analysed here would be the increase of (n-1) current limits of the tie lines. While the TSOs state that especially in off-peak situations the thermal current limit of the western 380 kV tie line Cantegrit-Hernani is indeed the limiting criterion for cross-border power transfer, we could however not simulate this effect with the available peak load data set. Therefore, no soft measures have been investigated for this border.

Network reinforcement

We have analysed the following reinforcement options:

1. Installation of an **additional 380/220 kV transformer in Vic (E)**

This measure directly addresses the critical outage situation of the base case. However, the new transformer has only a local impact and does not affect the general cross-border power flow pattern. It leads to a transmission capacity increase of **100 MW** after which the phase shifter in Pragnères (F) becomes the limiting network element (thermal overload after outage of 380 kV tie line Vic-Baixas).

2. Completion of the **double circuit 380 kV tie line from Cazaril (F) to Aragon (E)**

The new line would take 34 % of the France-to-Spain power transfer and especially relieve the 220 kV tie line Pragnères-Biescas, whose PTDF would decrease from 11 % to 5 %. In the analysed scenario, the phase shifter in Pragnères would no longer be necessary. (This may however change when additional capacity increase is achieved by other measures.) Due to the central location of the new line both existing 380 kV interconnections would also be relieved. On the other hand, southbound power flow inside Spain from Aragon to La Plana would increase significantly (PTDF increase from 8 % to 13 % plus additional base case load of 60 MW). As a consequence, the transformers in La Plana feeding the regional 220 kV grid would be overloaded. The additional transmission capacity would be **1400 MW**.

Power flows inside France are not significantly changed by this measure, except for the axis from Cubnezais to Gaudière parallel to the Pyrenees.

3. Construction of a **new 380 kV substation in Bescano (E) with connections to Baixas (F) and Sentmenat (E)**

This new interconnection is close to the existing Baixas-Vic tie line and therefore does – in contrast to project 2 – not create a completely new transmission axis. Hence, the load flow pattern on the border is changed less dramatically (PTDF decrease of Pragnères-Biescas 2.5 % compared to 6 % with project 2, Cantegrit-Hernani 5 % compared to 10 %). As a consequence, also the internal Spanish power flow distribution remains more similar to the base case.

A disadvantage of this solution is that because of the proximity of the then two interconnections in the east, after outage of one of the lines the other one has to transport almost all its power flow. This is also the critical incident which limits the transmission capacity. Nevertheless, the additional capacity would amount to **1300 MW**.

4. Construction of a **double circuit 380 kV tie line between Marsillon (F) and La Serna (E)**

This reinforcement would not lead to a significant inter-regional change of the power flow patterns inside France or Spain. The new lines' PTDF of 28 % is mostly fed by the PTDF reductions of the Cantegrit-Hernani (-11 %) and Baixas-Vic (-9 %) tie-lines. From the terminal station of the new tie line, La Serna, these flows are equally re-distributed to the northern and eastern Spanish grid regions. This means that the Spanish line from La Serna to Aragon – which in the base case is almost not affected by cross-border transfers – now has to transport 11 % of the imported power towards the Barcelona area. After a failure of this line, the additional power flow is shifted to the underlying 220 kV grid, thereby overloading the 380/220 kV transformer in La Serna. Therefore, the transmission capacity gain of this measure is limited to **900 MW**, which is significantly low compared to the two alternative 380 kV tie line projects. (Eventually, the high loading of the

220 kV grid could be avoided or reduced by operational measures. We could however not investigate such options.)

An overview of the simulation results is given in table I.6. (Note: The benefit of reinforcement projects at the Western Part of the border could not be investigated because this area is not critical in the available base case.)

#	Measure	Additional cross-border transmission capacity [MW]	Additional peak load losses after implementation [MW]	Resulting additional peak load losses after full use of new capacity [MW]
1	additional 380/220 kV transformer in Vic (E)	100	-1	0
2	double circuit 380 kV tie line Cazaril (F) to Aragon (E)	1400	-9	68
3	new 380 kV substation in Bescano (E) with connections to Baixas (F) and Sentmenat (E)	1300	-15	63
4	double circuit 380 kV tie line Marsillon (F) to La Serna (E)	900	-9	33

Table I.6: Impact of investigated reinforcement projects at French-Spanish border on transmission capacity and losses

J Questionnaire on NTC Assessment and Congestion

J.1 NTC Assessment

To determine transmission capacities, a distinction has to be made between commercial transactions and physical flows. A commercial transaction between two countries is defined as an increase of generation on the exporting side and an equivalent decrease of generation on the importing side in association with a corresponding adjustment of the exchange programmes.

The Net Transfer Capacity (NTC) represents the best estimate limit of transfer capacity available between two countries. It is the difference between the Total Transfer Capacity (TTC), i.e. the totally available commercial transmission capacity between two countries, and the Transmission Reliability Margin (TRM) being reserved by the TSOs for different purposes.

The basis for answering the following questions should be the procedure for calculating the NTCs published by ETSO twice a year. (We are aware of the fact that the ETSO members presently are defining new procedures for NTC assessment. However, in this questionnaire we refer to the existing definitions.)

J.1.1 TTC Assessment

We consider it appropriate to subdivide the description of the procedure for TTC assessment into four steps being discussed in the sections below:

- the basic method of calculation,
- the determination of the basic scenario for the calculations,
- the methodology and criteria to assess network security, and
- the limits of feasible network operation.

Methodology

The starting point of TTC assessment is a load and generation situation of the European interconnected system being as realistic as possible, below referred to as the basic scenario. Starting from this scenario, the commercial exchange between two countries is increased until security limits are breached. The power exchange is modelled by an increase of power generation in the exporting country and an equivalent decrease of power generation in the importing country at the same time. The TTC between the two countries corresponds to the maximum admissible commercial power exchange.

Question 1.1: Is TTC assessed according to the method described above? If not, what is the difference in the method applied?

Question 1.2: Are the installed capacities of generators in your own network area taken into account for modelling the generation shift?

Question 1.3: Do you know the locations and installed capacities of generators in the neighbouring network areas? If yes, are they taken into account for modelling the generation shift?

Question 1.4: How is the generation shift in the exporting and the importing country broken down to the individual generation units (e.g. proportional breakdown in relation to the generation in the basic scenario, ...)?

Determination of the basic scenario

At present, a load flow data set for the UCTE interconnected power system is prepared twice a year. This data set contains the topology and characteristics of the network and a forecasted load and generation situation of the UCTE network.

Question 1.5: Is the TTC and NTC assessment in the UCTE system based on this data set? Are similar data sets exchanged and applied in the other interconnected systems?

Question 1.6: If yes, is this data set modified (adjustment of network topology, generation, load)?

Question 1.7: If no, which other data are used?

To determine the TTC between two countries according to the ETSO definition, the commercial exchange between these countries that is incorporated in the basic scenario needs to be taken into account.

Question 1.8: Do you have knowledge of the commercial exchanges incorporated in the basic scenario? If no, which other information is available to determine these exchanges?

Assessment of network security

The existing publications do not define concrete rules for the assessment of network security that takes place at each step of TTC assessment, except for references to national Grid Codes. It can however be expected that in all countries, network security is at least assessed against the “n-1” principle, stating

that stable system operation must be possible at all times in case of a single failure of a network element or generation unit. In practice there is some space for interpretation related to this principle.

Question 1.9 Which failures of network components are investigated (single circuit lines, double circuit lines, transformers, busbars, ...)?

Question 1.10 Are corrective switching operations taken into account to remove congestion after failures?

Question 1.11 Are power plant failures – perhaps in combination with failures of network components – also taken into account?

Question 1.12 If yes, do you take the size of individual generation units into consideration?

Question 1.13 How do you adapt the power generation of the remaining generation units after a power plant failure? How do you take into account primary and secondary control?

Question 1.14 In which network areas (own area, neighbouring areas, non-neighbouring areas) do you investigate failures?

Question 1.15 Is network security only assessed for the basic scenario (plus the investigated commercial exchange) or are other scenarios with different load and generation situations taken into account (e.g. scenarios with modified generation dispatch in surrounding countries or additional loop flows caused by transactions between surrounding countries)?

Question 1.16 Which failures (e.g. power plant failures, failures of tie-lines, failures of lines inside a country, ...) and which criteria (voltage stability, availability of reactive power, thermal transfer capacity, steady-state stability, ...) typically have a limiting effect?

Question 1.17 Do you use other network analysis tools besides load flow calculations (e.g. stability calculations, short-circuit current calculations, Optimal Power Flow, ...)?

Limits of feasible network operation

During normal network operation and operation after failures, the electricity transmission capacity is subject to component-related limits (thermal transfer capacity) as well as network-related limits (voltage limits, stability).

Transfer limits

The admissible thermal loading of components is usually taken into account by defining “continuous current ratings”. As long as currents do not exceed these ratings, a violation of the admissible temperature limits is sufficiently unlikely even under most unfavourable environmental conditions. The maximum admissible temperature of overhead lines is determined by both material softening and minimum distance to earth.

Question 1.18 Which maximum temperature of overhead line conductors is admitted during continuous operation?

Question 1.19 Which environmental conditions (external temperature, wind speed) are assumed to determine the continuous current rating from the maximum admissible temperature of overhead lines?

Question 1.20 Are the continuous current limits regarded constant throughout the year, or do you apply higher limits in winter because of lower external temperature?

Question 1.21 Which conductor cross sections are predominantly used, and which are the resulting continuous current limits? Are there any additional restrictions to continuous currents due to minimum distances to earth?

Question 1.22 Which network elements additionally reduce the continuous current limits of the network branches (e.g. measuring transformers, disconnectors, ...)?

Question 1.23 In TTC assessment, which transfer limits are applied for transformers and overhead lines during normal operation (e.g. percentage of continuous current ratings)? Do you apply higher values in the contingency analysis? If yes, which?

Question 1.24 Do the transfer limits applied in TTC assessment for normal operation conditions correspond with the limits above which countermeasures actually need to be taken during system operation? If not, why not?

Question 1.25 Which countermeasures are taken if the transfer limits are breached during network operation?

Question 1.26 Which level of current (related to the continuous current ratings) causes the tripping of the overcurrent protection relays?

Voltage limits

Question 1.27 Are TTCs restricted by voltage limits?

The following questions on voltage limits only have to be answered if question 1.27 was answered with yes.

Question 1.28 Which voltage limits are applied for TTC assessment during normal network operation?

Question 1.29 Are the voltage limits identical for all busbars?

Question 1.30 Do the voltage limits used for TTC assessment correspond with the limits below/above which countermeasures actually need to be taken during system operation? If not, why not?

Question 1.31 Are extended voltage limits applied in the contingency analysis?

Question 1.32 Are the reactive power limits of generators taken into account in the contingency analysis?

J.1.2 TRM assessment

The publications of ETSO justify the necessity of TRM by

1. uncertainties in forecasting the system conditions like network topology, availability of network elements, or load and generation situation, and
2. power flows due to inadvertent exchanges.

For the superposition of these uncertainties U_i related to the predictability of power flows, the publications propose three possible formulas:

1.
$$U_{total} = \sum_n U_i$$

2.
$$U_{total} = \max(U_1, \dots, U_n)$$

3.
$$U_{total} = \sqrt{\sum_n U_i^2}$$

Question 1.33 Which contributions to TRM are taken into consideration?

Question 1.34 Are the different contributions calculated separately? If yes, which data are used, and what are the resulting contributions?

Question 1.35 How is the superposition of these contributions done? Which TRM values are obtained for which section of the country border?

J.2 Congestions

One of the objectives of this study is to identify congestions of transmission capacity that impose restrictions on cross-border electricity trading in Europe.

Question 2.1 Does any congestion occur on the borders of your network area? If yes, at which borders?

The following questions only have to be answered, if congestion occurs.

Question 2.2 During which time periods does the demand for transmission capacity exceed the available transmission capacity (e.g. daytime, day type, season, ...?)

Question 2.3 Do there exist procedures for allocation of scarce transmission capacity?

The following questions only have to be answered, if capacity allocation procedures exist.

Question 2.4 Do the NTC values published by ETSO twice a year correspond to the binding NTC values used for capacity allocation? If not, in which way is the method to assess binding NTC values different? How often (for which time periods) and how differentiated (e.g. day/night) are the binding values calculated?

We suppose that also the assessment of binding NTC values is usually not based on worst case assumptions, so that temporarily there may be less capacity available than assumed in the allocation stage.

Question 2.5 How often are the binding NTCs not fully available (irrespective of the actual utilisation)?

K Questionnaire on measures to increase transmission capacity

K.1 Purpose of this questionnaire

In the first phase of the study “Analysis of Electricity Network Capacity and Identification of Congestion” the most severely congested borders of the European electricity transmission networks have been identified. This questionnaire, dealing with measures to increase cross-border transmission capacity, addresses the TSOs adjacent to these borders. We believe that the complexity and individuality of the specific interconnections require a dialogue that reaches beyond answering a general, uniform questionnaire. Consequently, this document is mainly intended to provide an idea of the issues we would like to address and could ideally serve as a basis for a subsequent (telephone and/or personal) discussion.

Thank you very much in advance for your co-operation.

K.2 Operational Measures

K.2.1 Variation of ambient temperature

The actual transmission capacity of an overhead line is dependent on the actual ambient temperature. In contrast, the thermal current limits that are used to determine cross-border transmission capacity are generally based on certain assumptions with respect to the ambient temperature. Therefore, there might be a potential for an increase of cross-border transmission capacity by taking into account the variability of outside temperatures.

The treatment of the variation of ambient temperature with time of year and time of day can be separated into two categories:

- For **longer periods**, e.g. seasons or months, a typical variation of the ambient temperature can be derived from **statistical data**. Taking into account an error margin corresponding to the statistical uncertainty, such variation could be transformed into an according variation of thermal current limits of overhead lines.
- On a **day-ahead** basis, thermal current limits could be adjusted according to temperature **forecasts** while respecting the statistical forecast accuracy.

Alternatively or additionally, the day-night cycle of the temperature could be considered within both of the above categories.

The following two questions only apply to those TSOs who currently consider variable ambient temperatures when determining cross-border transmission capacity.

Question K.1: When evaluating statistical temperature data, which value do you use to derive the corresponding thermal current limit (e.g. “maximum temperature ever observed” or “temperature which is not exceeded throughout x % of the time”)?

Question K.2: Different TSOs apply different time periods for the differentiation of ambient temperatures (e.g. seasons, months). What was your reason to select “your” time periods?

The following question only applies to TSOs who assume a constant ambient temperature.

Question K.3: How do you judge the efforts and benefits of considering temperature variation in the future in order to increase allocable cross-border transmission capacity?

Sometimes congestion occurs also or even especially during night hours.

Question K.4: Is this the case at one of your borders? How do you judge the possibility to consider the daily temperature variation in order to raise transmission capacity during night hours?

Temperature forecasts may be an addition or an alternative to statistical temperature variation when determining thermal current limits.

Question K.5: How do you judge the utilisation of temperature forecasts to adapt thermal current ratings?

The treatment of tie lines requires a certain level of harmonisation between the involved TSOs.

Question K.6: Regarding your tie lines, are the same current limits (and, if applicable, time periods for variations) applied by both adjacent TSOs? Would it be more difficult to modify the thermal limits of tie lines than of internal lines?

K.2.2 Other operational measures

Similar to the ambient temperature, the wind speed (and direction) has a significant impact on the actual transmission capacity of overhead lines.

Question K.7: How do you judge the utilisation of wind speed forecasts to adapt thermal current ratings, e.g. on a day-ahead basis?

The aim of capacity allocation procedures is to restrict network usage so that violations of security limits are avoided. If, despite this, actual congestion occurs in the operational phase, (cross-border) re-dispatch measures have to be applied¹. Consequently, the amount of capacity which is allocated to the network users correlates to the frequency and amount of re-dispatch.

Question K.8: Do you currently apply cross-border re-dispatch as a regular measure to ensure system security? If yes, how often? If not, are there plans to do so in the future?

Question K.9: In your opinion, to which extent (e.g. how often per year) should cross-border re-dispatch be applied if it could be used to generally increase allocable transmission capacity?

K.3 Network reinforcements

K.3.1 Planned network reinforcements

This section of the questionnaire focuses on different types of reinforcement measures to increase cross-border transmission capacity. The questions refer to measures planned by your utility. For each project we would like to know

- the planned time of commissioning,
- the rating of the technical equipment that is planned to be installed (e.g. rated power of transformers) and

¹ „Re-dispatch“ here refers to any procedure which affects generation dispatch by request of the TSOs.

- the additional transmission capacity that can be obtained on the affected interconnection.

To facilitate answering, you might want to use the following table. For each project, please state in the first column the question number that it relates to.

question #	description of project	time schedule	rated power of equipment	additional transmission capacity

Measures if thermal current limits are critical

On the border [x – y] thermal current limits are the critical factor which limits transmission capacity. Therefore, to increase the transmission capacity, besides the installation of additional lines reinforcements measures can either be taken to increase current limits of existing lines or to optimise the distribution of load flows.

Question K.10: Which projects are planned to increase current limits of critical lines (e.g. heightening towers, installing new conductors, ...)?

Question K.11: Which projects are planned to optimise the distribution of load flows (installation of phase shifting transformers, FACTS elements, ...)?

Measures to improve voltage/var situation

On the border [x – y] a lack of reactive power in case of a failure of [xxx] limits the transmission capacity. Therefore to increase the transmission capacity besides the installation of new lines additional sources of reactive power could be installed.

Question K.12: Which plans do you have to install additional sources of reactive power (e.g. shunt capacitors, FACTS, ...)?

Installation of new lines or transformers

Apart from the above options, the construction of new lines or the installation of new transformers can be an adequate measure to increase transmission capacity regardless of the type of technical limit which determines the capacity of interconnections.

Question K.13: Is the installation of new lines or transformers planned to increase the transmission capacity on the border[s] [x – y, ...]? Where?

If new lines are planned:

Question K.14: Did you encounter authorisation problems?

If yes, which types of problems occurred and what are the consequences of these problems (e.g. higher costs, delayed commissioning, new route, ...)

K.3.2 Evaluation of network reinforcements

For the evaluation of network reinforcements technical as well as financial consequences have to be considered. Both are influenced by parameters individually set by each TSO. In the first part of the study only the parameters influencing the technical consequences were addressed (e.g. post-contingency overloading of branches). As we expect that investment decisions of TSOs are mainly influenced by expected financial consequences, we also would like to get some information on comparable parameters used in cost accounting.

Question K.15: Which interest rate do you apply?

Question K.16: How many years is the period under consideration?

Question K.17: Which demand rate [Euro/MW] and which energy price [Euro/MWh] is presumed for losses?